

TECHNICAL BULLETIN REACTION SOLVENT DIMETHYL SULFOXIDE (DMSO)

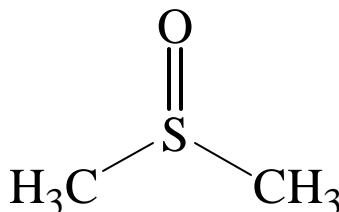

CAS Name: Methane, sulfinylbis
CAS Registry Number: 67- 68- 5

Dimethyl sulfoxide as manufactured by Gaylord Chemical, is a water-white almost odorless liquid, boiling at 189°C. and melting at above 18.2° C. It is relatively stable and easy to recover, miscible in all proportions with water and most common organic solvents and has a low order of toxicity.

Gaylord Chemical Corporation
P.O. Box 1209
Slidell, LA 70459-1209
(985) 649-5464

TABLE OF CONTENTS

		Page
INTRODUCTION		5
PART I.	PROPERTIES OF DMSO	6
	Physical Properties	6
	Thermal and Chemical Stability	6
	Recovery from Aqueous Solutions	12
PART II.	SOLVENCY CHARACTERISTICS OF DMSO	12
	Solubility of Salts	13
	Solubility of Resins and Polymers	14
	Solubility of Miscellaneous Materials	15
	Solubility of Gases	16
PART III.	REACTIONS OF DMSO	17
	1. Oxidation of DMSO	17
	2. Reduction of DMSO	17
	3. Reaction with Metals	17
	4. Reaction with Strong Bases -Dimethyl Ion	17
	5. Reaction with Acid Halides	18
	6. Reaction with Acid Anhydrides	18
	7. Halogenation of DMSO	19
	8. Reaction with Phenols and Aniline	19
	9. Alcohol Oxidation with DMSO	20
	a) Acetic Anhydride	21
	b) Trifluoroacetic Anhydride	21
	c) Dicyclohexylcarbodiimide	21
	d) Phosphorus Pentoxide	22
	e) Sulfur Trioxide-Pyridine	22
	f) Oxalyl Chloride	23
	10. Kornblum Reaction	23
	11. Methoxydimethylsulfonium Salts and Trimethyloxosulfonium Salts	23
PART IV.	DMSO AS A REACTION SOLVENT	24
	A. DISPLACEMENT REACTIONS IN DMSO	24
	Anions-Nucleophiles (Bases):	
	1. Acetylide Ion	24
	2. Alkoxide Ion	24
	3. Amides	26
	4. Amines	28
	5. Ammonia	30
	6. Azide Ion	30
	7. Carbanions	32
	8. Carboxylate Ion	34
	9. Cyanate Ion	35
	10. Cyanide Ion	35
	11. Halogen Ion	39
	12. Hydroxide ion	40
	13. Mercaptide (or Thiopenoxide) Ion	42
	14. Nitrite Ion	43
	15. Phenoxide Ion	44
	16. Sulfide (or Hydrosulfide) and Thiosulfate Ions	46
	17. Thiocyanate Ion	47
	B. BASES AND BASE CATALYZED REACTIONS IN DMSO	48
	Bacities in DMSO	48
	Proton Removal	48
	ELIMINATION REACTIONS	51
	1. Cope Elimination	51
	2. Decarboxylation and Decarboxylation	51
	3. Dehalogenation	52
	4. Dehydrohalogenation	54
	5. Nitrogen Elimination	57

	Page
6. Sulfenate Elimination	59
7. Sulfonate Elimination	59
8. Water Elimination-dehydration	60
ISOMERIZATION REACTIONS	62
1. Acetylene Isomerization	62
2. Allyl Group Isomerization	63
3. Diene, Triene Isomerization	63
4. Olefin Isomerization	64
5. Racemization	65
C. OTHER REACTIONS IN DMSO	
ADDITION REACTIONS	66
a) Additions to acetylenes	66
b) Additions to olefins	67
c) Additions to nitriles	69
d) Additions to isocyanates	69
CONDENSATION REACTIONS	69
a) Aldol-type condensations	69
b) Ester condensations	70
c) Dieckmann condensation-cyclization	71
d) Mannich reaction	72
e) Michael condensation	72
f) Reformatsky reaction	73
g) Thorpe-Ziegler condensation	73
h) Ullmann-type condensations	73
i) Wittig reaction	73
OXIDATION REACTIONS	74
a) Autoxidation	74
b) Chemiluminescence	76
c) Other oxidations involving oxygen	77
d) Dehydrogenation	77
e) Hypohalite oxidations	78
f) Lead tetraacetate oxidations	78
g) Silver compound oxidations	79
h) Superoxide and peroxide oxidations	80
REDUCTION REACTIONS	80
1. Reduction of Alkyl Halides and Sulfonates	81
a) Reductions with sodium borohydride	81
b) Reductions with chromous ion	82
c) Reductions with dimethyl ion	82
d) Reductions with hydrazine	82
e) Reductions by electrolysis	82
2. Reduction of Carbonyl Compounds	82
a) Reductions with borohydrides	82
b) Catalytic reduction	83
c) Electrochemical reduction	83
d) Wolff-Kishner reduction	83
3. Reduction of Nitroaromatics	83
4. Reduction of C=C Systems	84
SOLVOLYTIC REACTIONS	85
1. Hydrolysis	85
a) Aliphatic halide hydrolysis	85
b) Aromatic halide hydrolysis	85
c) Amide hydrolysis	86
d) Epoxide hydrolysis	86
e) Ether hydrolysis	86
f) Nitrile hydrolysis	86
g) Saponification	87
2. Alcoholysis, Aminolysis	87
3. Transesterification (Ester Interchange)	88

	Page	
PART V.	USES OF DMSO	88
	1. Polymerization and Spinning Solvent	88
	Polymerization Solvent for Heat-Resistant Polymers	88
	2. Extraction Solvent	89
	3. Solvent for Electrolytic Reactions	89
	4. Cellulose Solvent	89
	5. Pesticide Solvent	90
	6. Cleanup Solvent	90
	7. Sulfiding Agent	90
	8. Integrated Circuits	90
PART VI.	TOXICITY, HANDLING, HAZARDS, ANALYSIS	90
	1. Toxicity and Handling Precautions	90
	2. Comparative Toxicity of Commercial Solvents	91
	3. Chemical Reactions to be Avoided with DMSO	91
	4. Analytical Procedures	92
	a) Gas chromatographic analysis of DMSO	92
	b) DMSO freezing point	92
	c) Water by Karl Fischer titration	92
PART VII.	BIBLIOGRAPHY	93

TABLES AND FIGURES

		Page
Table I	Physical Properties of DMSO	6
Table II	Results of Reflux of DMSO for 24 Hours with Various Compounds	9
Table III	Refluxing of DMSO and Mixtures for Shorter Periods	9
Table IV	Effect of Heating DMSO with Concentrated Acids	10
Table V	Solubility of Salts in DMSO	13
Table VI	Solubility of Resins and Polymers in DMSO	14
Table VII	Solubility of Miscellaneous Materials in DMSO	15
Table VIII	Solubility of Gases in DMSO	16
Table IX	Solubility of Various Bases in DMSO	24
Table X	Solubility of Sodium Azide in Four Solvents	31
Table XI	Acidities in DMSO	50
Table XII	Single-Dose Toxicity (Rats) of Some Common Solvents	91
Table XIII	Single-Dose Toxicities to Mice of 4M Solvents	91
Figure 1	Vapor Pressure-Temperature DMSO	7
Figure 2a	Freezing Point Curve for DMSO-Water Solutions (Wt % water)	8
Figure 2b	Freezing Point Curve for DMSO-Water Solution (Wt % water)	8
Figure 3	Viscosity of DMSO	8
Figure 4	Viscosity of DMSO-Water Solutions	8
Figure 5	Thermal Stability of DMSO	11
Figure 6	DMSO Recovery from Aqueous Solutions	12
Figure 7	Solubility of NaCN in DMSO	36
Figure 8	Solubility of NaCl in DMSO-H ₂ O Mixtures	36
Figure 9	Solubility of Hydroxides in Aqueous DMSO	41
Figure 10	Acidity Functions of Bases in DMSO	49

INTRODUCTION

Dimethyl sulfoxide or DMSO is a highly polar, high boiling, aprotic, water miscible, hygroscopic organic liquid. It is essentially odorless, water white and has a low order of toxicity.

Chemically, DMSO is stable above 100° C in alkaline, acidic or neutral conditions. Prolonged refluxing at atmospheric pressure will cause slow decomposition of DMSO. If this occurs, it can be readily detected by the odor of trace amounts of methyl mercaptan and bis(methylthio)methane. The rate of decomposition is a timetemperature function that can be accelerated by the addition of acids and retarded by some bases.

DMSO is a versatile and powerful solvent that will dissolve most aromatic and unsaturated hydrocarbons, organic nitrogen compounds, organo-sulfur compounds and many inorganic salts. It is miscible with most of the common organic solvents such as alcohols, esters, ketones, lower ethers, chlorinated solvents and aromatics. However, saturated aliphatic hydrocarbons are virtually insoluble in DMSO.

As a reaction solvent, DMSO is valuable for displacement, elimination, and condensation reactions involving anions. In DMSO, the rates of these reactions are often increased by several orders of magnitude. In free radical polymerizations, higher average molecular weights have been reported when DMSO was used as the reaction solvent.

The dominant characteristics of DMSO most important in its usefulness as a reaction solvent are its high polarity, its essentially aprotic nature, and its solvating ability toward cations. The high dipole moment of the sulfur-oxygen bond (4.3) and the high dielectric constant (approx. 48) for bulk DMSO suggest the solvating properties and ability to disperse charged solutes. DMSO is not a hydrogen donor in hydrogen bonding and poorly solvates anions except by dipolar association to polarizable anions. The hydrogen atoms of DMSO are quite inert, although they are replaceable under sufficiently severe conditions (bulk pKa = 35.1). The oxygen of DMSO is somewhat basic and participates strongly as a hydrogen bond acceptor. DMSO forms isolatable salts with several strong acids.

Owing to its chemical and physical properties, DMSO can be efficiently recovered from aqueous solutions. Commercial users of DMSO employ a variety of processing schemes in their recovery systems. All of these are based on evaporation or fractional distillation because of simplicity of design and operation. Unlike some other solvents, DMSO can be easily separated from water by distillation in substantially pure form. For example, DMSO containing less than 500 ppm water can be recovered from a solution containing 50 weight percent water with only 15 column plates at a reflux ratio of 1:1.

Dimethyl sulfoxide occurs widely in nature at levels of 3 ppm or less. It has been found in spearmint oil, corn, barley, malt, alfalfa, beets, cabbage, cucumber, oats, onions, swiss chard, tomatoes, raspberries, beer, coffee, milk and tea. DMSO is a common constituent of natural waters. It has been identified in seawater in the zone of light penetration where it may represent an end product of algal metabolism. Its occurrence in rainwater may result from oxidation of atmospheric dimethyl sulfide which in turn occurs as part of the natural transfer of sulfur of biological origin.

No attempt has been made in this bulletin to present a complete literature survey of all the uses of DMSO as a reaction solvent, solvent, or reactant. A few carefully chosen references have been selected to illustrate the most important areas of DMSO chemistry. For persons wishing to learn more about DMSO as a reaction solvent, or any other information in this bulletin, please write or call:



**P.O. Box 1209
Slidell, LA 70459-1201
(985) 649-5464**

PART I. PROPERTIES OF DMSO
TABLE I. Physical Properties of DMSO

		Reference
Molecular Weight	78.13	
Boiling Point at 760 mm Hg	189 °C (372°F)	(342)
Freezing point	18.45°C (65.4°F)	(342)
Molal freezing point constant, °C/(mol)(kg)	4.07	(2151)
Refractive index n _D 25	1.4768	(581)
Surface tension at 20°C	43.53 dynes/cm	(2223)
Vapor pressure, at 25°C	0.600 mmHg	(372)
Density, g/cm ³ , at 25°C	1.099	(581)
Viscosity, cP, at 25°C	2.0 (see Figs. 3 & 4)	(581)
Specific heat at 29.5°C	0.47+/- 0.015 cal/g/°C	(3215)
Heat capacity (liq.), 25°C	0.47 cal/g/°C	(2900)
Heat capacity (ideal gas)	C _p (T°K)=6.94+5.6x10 ⁻² T-0.227x10 ⁻⁴ T ²	(353)
Heat of fusion	41.3 cal/g	(232)
Heat of vaporization at 70°C	11.3 kcal/mol (260 BTU/lb)	
Heat of solution in water at 25°C	-54 cal/g, @ ∞ dilution	(3215)
Heat of combustion	6054 cal/g; (473 kcal/mole)	(342)
Flash point (open cup)	95°C (203°F)	
Auto ignition temperature in air	300-302°C (572-575°F)	
Flammability limits in air		
lower (100°C)	3-3.5% by volume	
upper	42-63% by volume	
Coefficient of expansion	0.00088/°C	(342)
Dielectric constant, 10MHz	48.9 (20°C)	(342)
	45.5 (40°C)	
Solubility parameter	Dispersion 9.0	(8070)
	Polar 8.0	
	H-bonding 5.0	
Dipole moment, D	4.3	(342)
Conductivity, 20°C	3x10 ⁸ (ohm ⁻¹ cm ⁻¹)	(342)
80°C	7x10 ⁸ (ohm ⁻¹ cm ⁻¹)	
PKa	35.1	(10411)

Thermal and Chemical Stability of DMSO

As shown in Figure 5, DMSO is highly stable at temperatures below 150° C. For example, holding DMSO at 150° C for 24 hours, one could expect a loss of between 0.1 and 1.0%. Retention times even in batch stills are usually considerably less than this, and therefore, losses would be correspondingly less.. It has been reported that only 3.7% of volatile materials are produced during 72 hours at the boiling point (189° C) of DMSO (1). Slightly more decomposition, however, can be expected with the industrial grade material. Thus, about 5% DMSO decomposes at reflux after 24 hours (3921). Almost half of the weight of the volatile materials is paraformaldehyde. Dimethyl sulfide, dimethyl disulfide, bis(methylthio)methane and water are other volatile products. A small amount of dimethyl sulfone can also be found. The following sequence of reactions explains the formation of these decomposition products (1):



DMSO is remarkably stable in the presence of most neutral or basic salts and bases (3922). When samples of DMSO (300g) are refluxed for 24 hours with 100g each of sodium hydroxide, sodium carbonate, sodium chloride, sodium cyanide, sodium acetate and sodium sulfate, little or no decomposition takes place in most cases. The results are shown in Table II below (3922):

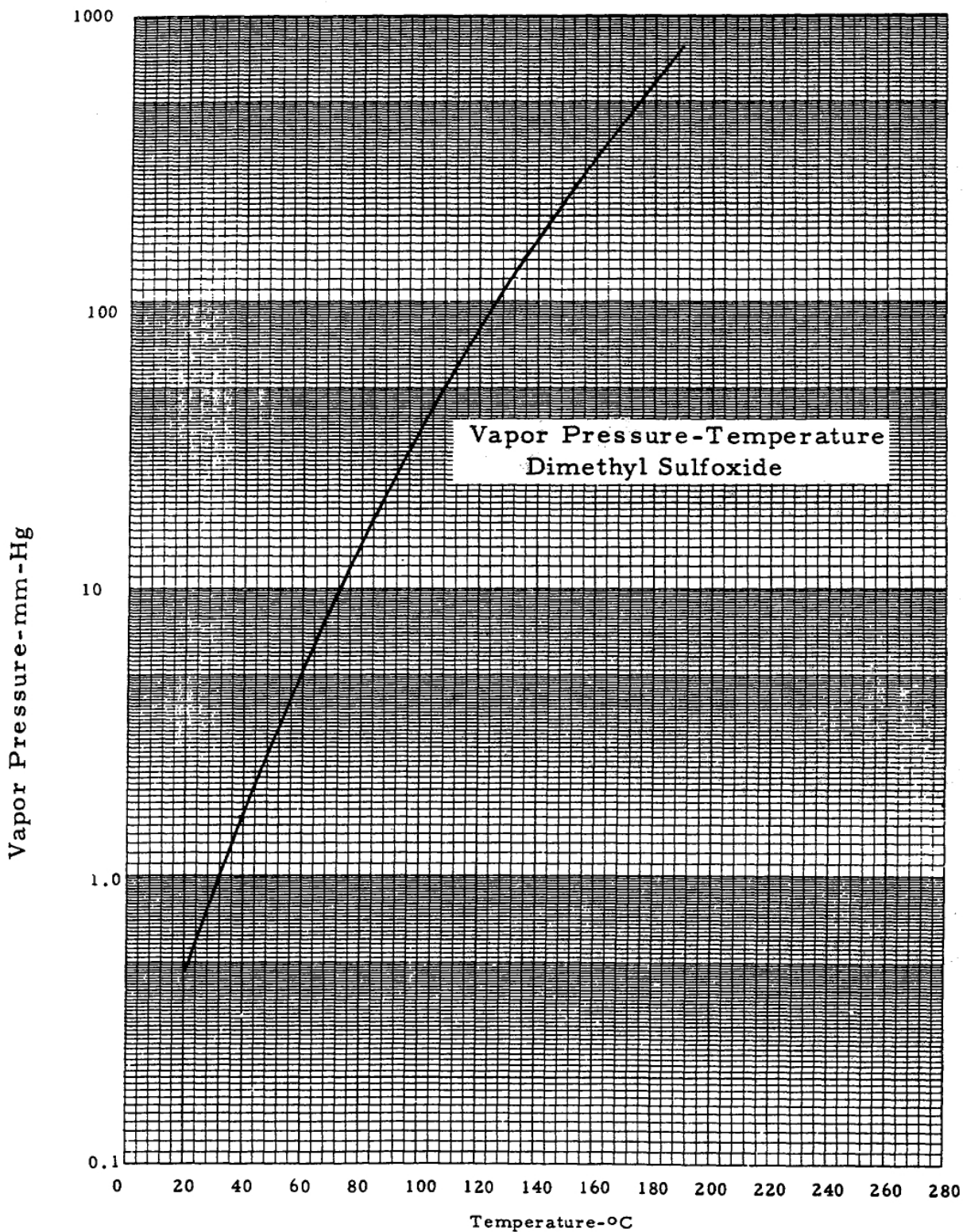

FIGURE 1

FREEZING POINT CURVES FOR DMSO-WATER SOLUTIONS

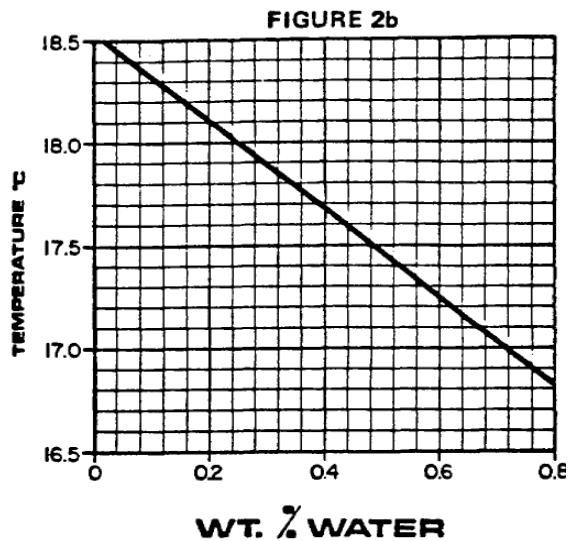
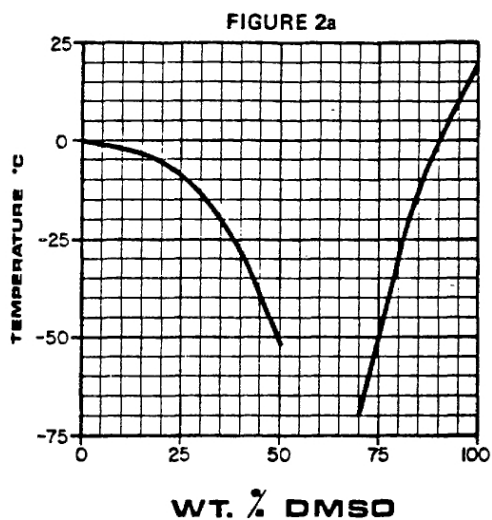

FIGURE 3
VISCOSITY OF DMSO

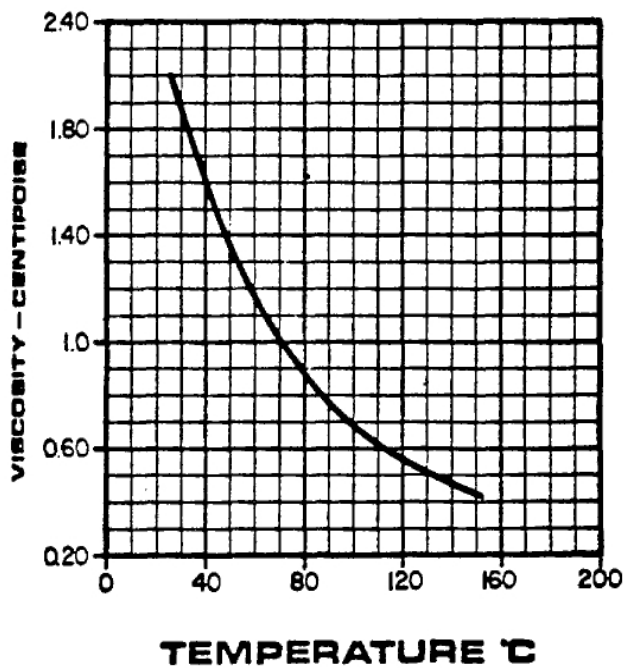

FIGURE 4
VISCOSITY OF DMSO-WATER SOLUTIONS
25°C

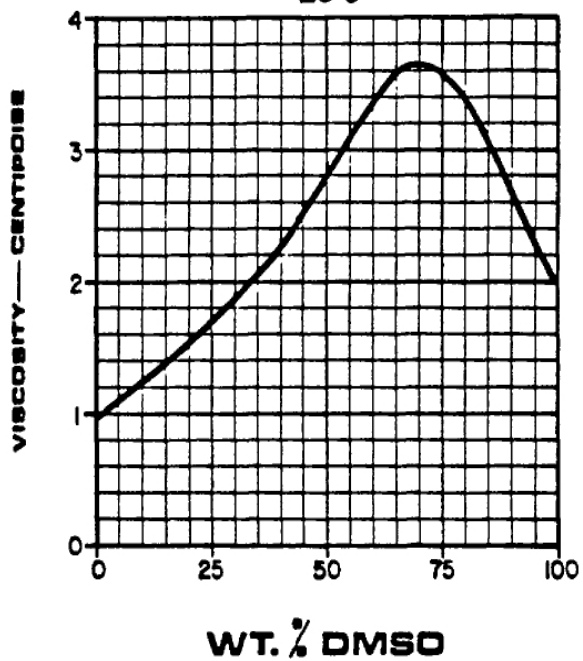

TABLE II
Results of Reflux of DMSO for 24 Hours with Various Compounds

Compound (1008) in 300 g DMSO	Reflux Temp., ° C.	DMSO Recovered % of Original	DMS ^(a)	% of Decomposition Products,			M Md
				DMDS ^(b)	BMTM ^(c)	HCHO	
NaOH	185-140e	93.7	63	31			
Na ₂ CO ₃	190	96.3		14			
NaCl	190	98.7		15			
NaCN	148-164f	100.0					
NaOAc	182-187	97.0	22	33	8	20	
Na ₂ SO ₄	181-148g	85.4	66				11
DMSO only	189	98.0	15	30	30		

(a) Dimethyl sulfide

(b) Dimethyl disulfide

(c) Bis(methylthio)methane

(d) Methyl mercaptan

(e) Reflux temp. decreased from 185°C to 140°C over the first 16 hours.

(f) Reflux temp. was 148°C for 20 hours; increased to 164° C during the last 4 hours.

(g) Reflux temp. decreased gradually from 181°C to 148° C.

DMSO does not seem to be hydrolyzed by water and very little decomposition of DMSO takes place when it is heated under reflux for periods of 5 to 16 hours. The following tests, shown in Table III, have been performed: 1) 10 parts DMSO + 1 part water, 2) 60 parts DMSO + 5 parts water + 1 part sodium hydroxide, 3) 60 parts DMSO + 12 parts water + 1 part sodium bicarbonate, 4) DMSO alone (3922):

TABLE III
Refluxing of DMSO and Mixtures For Shorter Periods

Composition of Sample, Parts	Reflux Time, °C.	Time Hr.	DMSO 100	Organic Product Composition,		BMTM
				DMS	DMDS	
10 DMSO:1 H ₂ O	152	5		0	0	0
		15	99.7	0.15	0	0.15
60 DMSO:5 H ₂ O:1 NaOH	155	5	99.8	0.1	0.1	0
		8	99.3	0.6	0.1	0
60 DMSO:12 H ₂ O:1 NaHCO ₃	131	6	99.9	0.1	0	0
		12	99.8	0.2	0	0
DMSO only	191	5	99.8	0.1	0.1	0
		9	99.1	0.2	0.2	0.5
		16	99.0	0.2	0.2	0.6

DMSO is also stable in the presence of concentrated sulfuric or hydrochloric acid at 100° C for up to 120 minutes of heating at atmospheric pressure. Phosphoric acid causes more rapid decomposition of DMSO than does sulfuric or hydrochloric acid. Detected decomposition products are dimethyl sulfide, dimethyl disulfide, and, in smaller quantity, formaldehyde. The results are shown in Table IV (3920):

TABLE IV
Effect of Heating DMSO with Concentrated Acids - (200g DMSO with 20g of concn. acid)

Acid	Conc.	Temp., ° C.	Time, Min.	DMSO Left, %	% of Decomposition Products		
					DMS ^(a)	DMDS ^(b)	HCHO
H2SO4	36N	100	15	99	100		
			30	99	100		
			120	98	100		
H2SO4	36N	125	- 15	86	7	93	
			150	86	7	93	
			210	80	10	90	
H3 P04	85%	100	15	92	25	75	
			30	89	45	55	
			45	89	45	55	
			60	87	46	54	
			120	87	46	54	
H3 P04	85%	125	15	84	25	75	some
			60	82	33	67	
			150	82	33	67	
HCl	12N	95	15	99	100		
			30	99	100		
			60	99	100		
			120	98	100		
HCl	12N	115	15	93	100		
			30	92	100		
			45	87	100		
			60	87	100		
			120	87	100		some

(a) Dimethyl Sulfide
(b) Dimethyl Disulfide

THERMAL STABILITY OF DMSO

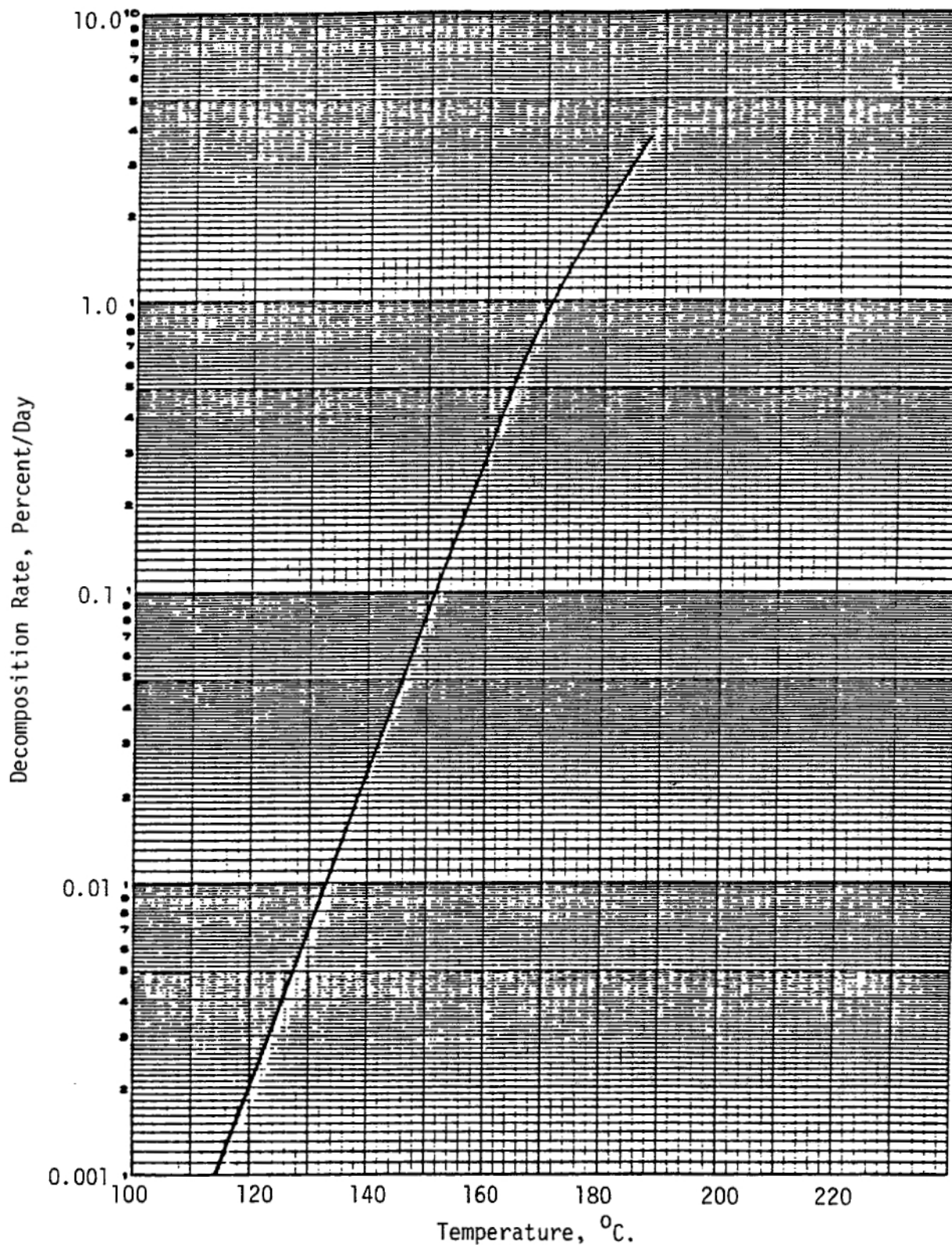

FIGURE 5

DMSO RECOVERY FROM AQUEOUS SOLUTIONS

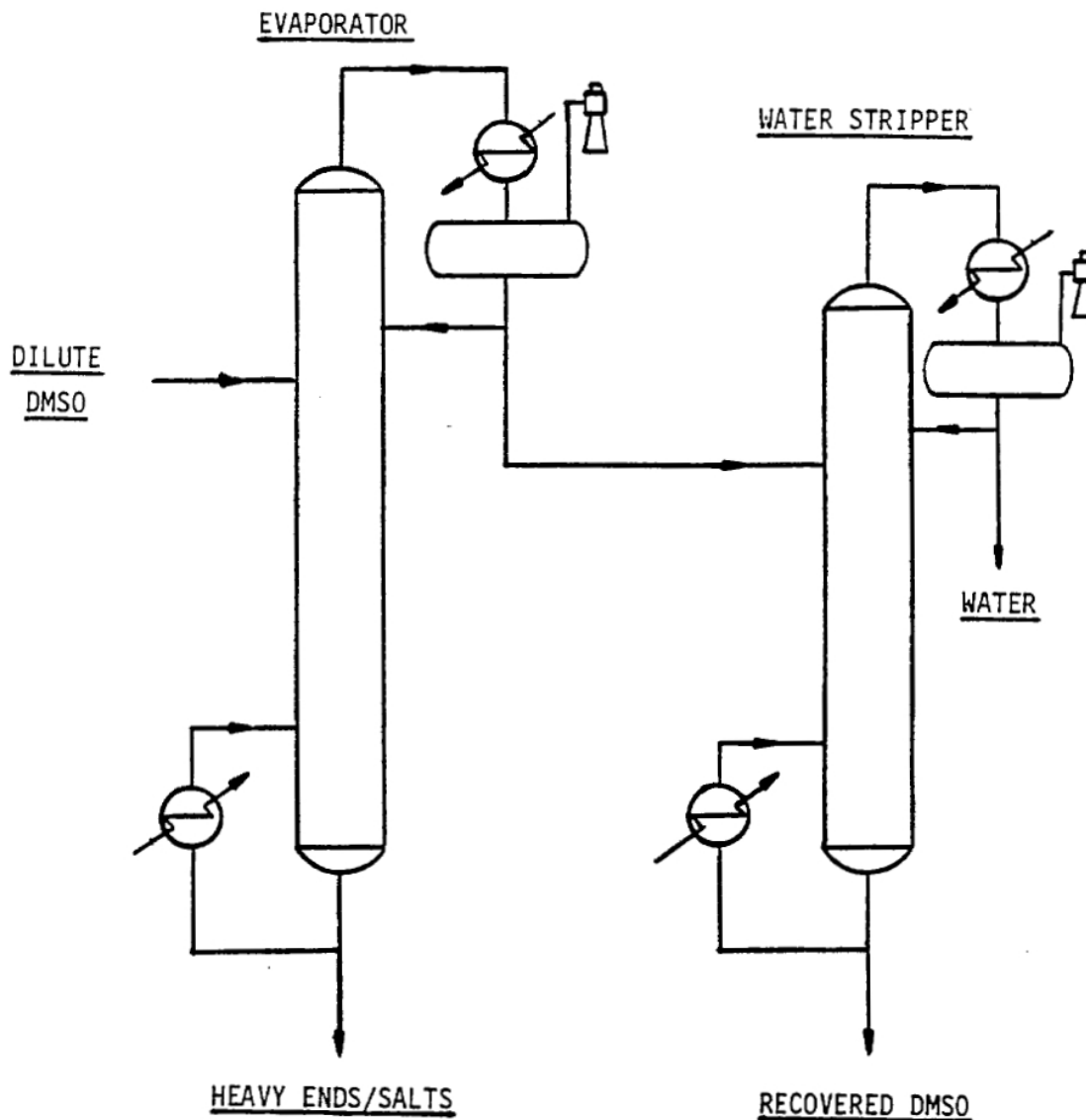

FIGURE 6

Recovery from Aqueous Solutions

Many chemical processes using DMSO require the addition of water to stop the reaction or to separate the product from the solvent (DMSO). DMSO can be separated efficiently and cleanly from this water and other impurities by distillation. DMSO distillations are not complicated by any known azeotropes.

A typical feed to a recovery operation is relatively weak in DMSO - 10 to 20%. There would usually be two vacuum distillation steps in the recovery:

- 1) Evaporation of the DMSO-water solution overhead to eliminate less volatile impurities, if any are present, and
- 2) Fractional distillation of the DMSO-water solution to recover pure DMSO.

Recovery may be done batchwise or continuously, employing moderate conditions. An operating pressure of about 100 mm Hg abs. would allow the use of 85 psig steam and normally available cooling water.

PART II SOLVENCY CHARACTERISTICS OF DMSO

The solvent characteristics of DMSO derive mainly from its being highly polar and aprotic. Because of its high polarity it forms association bonds with other polar and polarizable molecules, including itself. Thus, it is miscible with water and almost all types of organic liquids except the saturated alkanes. It has a high solvency for the large organic molecules containing polar groups. DMSO has also exhibited an ability to dissolve many inorganic salts, particularly those of the transition metals or those which have nitrates, cyanides or dichromates as their anions.

The following tables of solubilities are offered as a guide and an easy reference.

Solubility of salts -----	Table V
Solubility of resins and polymers-----	Table VI
Solubility of miscellaneous materials -----	Table VII
Solubility of gases -----	Table VIII

The difficulty of predicting solubility characteristics suggests that each specific compound be checked for its solubility in DMSO rather than generalizing from reported solubilities. Because of the variability of resins and polymers from one manufacturer to another, tradenames and companies have been used to identify accurately the materials in Table VI. The study of co-solvent possibilities utilizing DMSO has not been included as the complexity and diversity of this field are too broad to give adequate coverage. It will be noted however from Table VII that DMSO is compatible with most of the common solvents. This compatibility and the strong solvency properties of DMSO indicate numerous possibilities for co-solvent systems to perform given tasks efficiently and economically.

TABLE V
Solubility of Salts in DMSO (794)

	Solubility Grams/100 cc DMSO			Solubility Grams/100 cc DMSO	
	25°C.	90-100°C.		25°C.	90-100°C
Aluminum sulfate (18H ₂ O)	Insol.	5	Lithium dichromate (2 H ₂ O)	10	-
Ammonium borate (3H ₂ O)	10	-	Lithium nitrate	10	-
Ammonium carbonate (H ₂ O)	1	-	Magnesium chloride (6 H ₂ O)	1	-
Ammonium chloride	Insol.	10	Magnesium nitrate (6 H ₂ O)	40	-
Ammonium chromate	1	-	Manganous chloride (4 H ₂ O)	20	-
Ammonium dichromate	50	-	Mercuric acetate	100	-
Ammonium nitrate	80	-	Mercuric bromide	90	-
Ammonium thiocyanate	30	-	Mercuric iodide	100	-
Barium nitrate	1	-	Molybdenum bromide	1	Reacts
Beryllium nitrate (4 H ₂ O)	10	-	Nickel chloride (6 H ₂ O)	60	-
Bismuth trichloride	1	-	Nickel nitrate (6 H ₂ O)	60	-
Cadmium chloride	20	-	Potassium iodide	20	20
Cadmium iodide	30	-	Potassium nitrate	10	-
Calcium chloride	Insol.	1	Potassium nitrite	2	-
Calcium dichromate (3 H ₂ O)	50	-	Potassium thiocyanate	20	50
Calcium nitrate (4 H ₂ O) 2	30	-	Silver nitrate	130	180
Ceric ammonium nitrate	1	-	Sodium dichromate (2 H ₂ O)	10	-
Cobaltous chloride (6 H ₂ O)	30	Misc. m.p. 86°C.	Sodium iodide	30	-
Cupric acetate (H ₂ O)	Insol.	6	Sodium nitrate	20	-
Cupric bromide	1	20 150°C.	Sodium nitrite	20	-
Cupric chloride (2 H ₂ O)	Insol.	27	Sodium thiocyanate	1	-
Cuprous iodide	1	-	Stannous chloride (2 H ₂ O)	40	-
Ferric ammonium sulfate (12 H ₂ O)	Insol.	Misc. m.p. 40° C.	Strontium bromide (6 H ₂ O)	5	-
Ferric chloride (6 H ₂ O)	30	90	Strontium chloride (2 H ₂ O)	10	-
Ferrous chloride (4 H ₂ O)	30	90	Tungsten hexachloride	5	-
Gold chloride	5	-	Uranyl nitrate (6 H ₂ O)	30	-
Lead chloride	10	-	Vanadium chloride	-	1
Lead nitrate	20	60	Zinc chloride	30	60
			Zinc nitrate (6 H ₂ O)	55	-

TABLE VI
Solubility of Resins and Polymers in DMSO

Material	Grams Soluble in 100 cc DMSO		Comments
	20-30°C	90-100°C	
Polyacrylics			
Orlon (du Pont)	-	20	Viscous soln.
Acrilan (Monsanto)	>25	-	
Verel (Eastman)	>5		25 at 130°C with some decomposition
Creslan (Am. Cyanamid)	5		25 at 130°C
Zefran (DOW)	-	Insol.	
Polyamides			
Nylon 6	-	Insol.	40 at 150°C
Nylon 6/6	-	Insol.	25 at 150°C
Nylon 6/10	-	Insol.	40 at 150°C
Cellulose			
Cellulose triacetate	10	20	
Viscose rayon	-	<1	
Cellophane	-	Insol.	
Carboxymethyl cellulose	-	Insol.	
Epoxies			
Epon 1001 (Shell)	50	-	
Epon 1004 (Shell)	50	-	
Epon 1007 (Shell)	50	-	
Methacrylates			
Lucite 41, 45 (du Pont)	-	<1	
Plexiglass (Rohm & Haas)	-	<1	
Polycarbonates			
Lexan (General Electric)	-	>5	
Merlon (Mobay)	-	Insol.	
Polyesters			
Dacron (du Pont)	-	>1	Dissolves at 160°C ppts.
CX 1037 (Goodyear)	-	7	
Atlac (ICI-America)	-	50	
Silicones			
Dow Corning 803 soln.	Miscible	-	
Dow Corning 805 soln.	Miscible	-	
Dow Corning "Sylkyd 50"	Miscible	-	
Dow Corning Z6018 (flake)	70	-	
Urethanes			
Vithan (Goodyear)	-	100	
Vinyls – Polymers & Co-polymers			
Butvar B-76 (Monsanto)	-	20	Very viscous
Formvar 7/70 E (Monsanto)	-	42	Very viscous
Elvanol 51-05 (du Pont)	-	90	Viscous
Elvanol 52-22 (du Pont)	-	15	Viscous
Elvanol 71-24 (du Pont)	-	30	Viscous
Polyvinyl pyrrolidone (GAF)	30	>100	
Geon 101 (PVC Goodrich)	-	10	
Vynlite VYHH (Union Carbide)	2	30	
Teslar (du Pont)	-	-	Partially sol. at 160-170°C

Vinylidenes

Darvan (Goodrich)	5	-	Soln. Cloudy and viscous
Saran film (Dow)	-	30	
Geon 200 x 20 (Goodrich)	-	20	
DNA (Goodrich)	>5	-	25 at 130°C

Other Resinous Materials

Melmac 405 (Am. Cyanamid)	70	-	
Neoprene	Insol.	Insol.	
Polyethylene	Insol.	Insol.	
Polystyrene	-	-	Sol. At 150°C ppts at 130°C
Rosin (Hercules)	>100	-	
Penton (chlorinated polyether) (Hercules)	-	5	
Teflon (du Pont)	Insol.	Insol.	
Vinsol (Hercules)	50	>100	

TABLE VII
Solubility of Miscellaneous Materials in DMSO

Material	Solubility Grams/100 cc DMSO		Material	Solubility Grams/100 cc DMSO	
	20-30°C	90-100°C		20-30°C	90-100°C
Acetic acid	Miscible	-	Glycerine	Miscible	-
Acetone	Miscible	-	Glycine	<0.05	0.1
Acrawax	<1	>1	Hexane	2.9	-
Acrawax B	Insol.	4	Hy-wax 120	-	<1
Aniline	Miscible	-	Iodine	Soluble	-
Beeswax	-	<1	Isoprene	Miscible	-
Benzene	Miscible	-	Kerosene	0.05 (0.5% DMSO soluble in	11 (gets cold)
Benzidine	Soluble	-	Lanolin, hydrated (Lanette O)		
Benzidine methane sulfonate	Insol.	-	Lauryl amide (Amid 12)	10	>20
Bromine	Reacts	-	Lorol 5	Miscible	-
			Lubricating oil	0.4	-
Butenes	2.1	-	Methionine	0.1	0.3
Calcium methyl sulfonate	Soluble	-	Methyl borate	Miscible	-
Camphor	Soluble	Soluble	Methyl caprate	-	Miscible
Candelilla wax	-	<1	Methyl iodide	Miscible	Reacts
Carbon	Insol.	-	Methyl laurate	7	Miscible
Carbon disulfide	90	-	Methyl mercaptan	40	-
Carbon tetrachloride	Miscible	-	N-methyl morpholine	Miscible	-
Carbowax 600	Miscible	-	Methyl palmitate	Immiscible	Misc. 130-180°
Carbowax 6000	Insol.	8	Methyl salicylate	Miscible	-
Carnauba wax	-	<1	Methyl sulfonic acid	Miscible	-
Castor oil	Miscible	-	Methylene chloride	Miscible	-
Ceresin wax	-	<1	Microcrystalline wax	-	<1
Chlorine	Reacts	-	Morpholine	Miscible	Miscible-
Chloroform	Miscible	-	Naphthalene	40	Insol.
Chlorosulfonic acid	Reacts	-	Neoprene	Insol.	-
Citric acid	>70	-	Nitrobenzene	Miscible	-
Coconut oil	0.3	1.3	Oleic acid	Miscible	-
		Misc.-160°C	Ouricuri wax	-	1
Cork	Softens	Softens	Oxalic acid	38	-
Cresylic acid	Miscible	-	Paint (dried)	Softens & dissolves	
Cumene	Miscible	-	Palmitic acid	100	
Cyclohexane	4.67	-	Paraffin	Insoluble	-
Cyclohexylamine	Miscible	-	Paraformaldehyde	Insoluble	Slightly soluble
Decalin	4.5	-	Pentaerythritol	5-10	30
n-Decane	0.7	-	n-Pentane	0.35	-
Di-n-butylamine	11	-	Pentene 1 & 2	7.1	-
o-Dichlorobenzene	Miscible	-	Perchloric acid	Reacts violently	-
p-Dichlorobenzene	Very Soluble	-	Petroleum ether	3 (DMSO soluble 0.3-0.5% in	petroleum ether)
Dichlorodiphenyltrichloroethane	4	100			
Dicyandiamide	40	-	Phenol	Soluble	-
Dicyclohexylamine	4.5	-	Phosphoric acid	Miscible	-
Diethylamine	Miscible	-	Phosphorus trichloride	Reacts vigorously	-
Diethyl ether	Miscible	-	Phthalic acid	90	-
bis-(2-ethylhexyl)amine	Miscible	-	Isophthalic acid	68	76
Diethyl sulfide	0.7	-	Terephthalic acid	26	33
Di-isobutyl carbinol	Miscible	-	Picric acid	Soluble	-

Di-isobutylene	3.3 (0.6% DMSO soluble in di-isobutylene)	-	Pyridine	Miscible	-
Dimethyl ether	4.4	-	Pyrogallol	50	-
Dimethyl formamide	Miscible	-	Rosin	>100	-
Dimethyl sulfide	Miscible	-	Rosin soap	Slightly soluble	0.9
Dimethyl sulfone	33.9	Miscible	(Hercules Dresinate X)		
Dioxane	Miscible	-	Sevin	50	-
Diphenyl	Very Soluble	-	Shellac, white, dried	-	80
Dipentene	10	-	Silicon tetrachloride	Reacts vigorously	
n-Dodecane	0.38	-	Sodium	-	Reacts
Dodecylbenzene (Neolene 400)	3.5	-	Sorbitan sesquioleate	2.5	-
Dyes	-	-	Sorbitan trioleate	-	Miscible
Burnt Sugar	Soluble	-	Sorbitol	60	>180
FD&C Blue	Soluble	-	Soybean oil	0.6	-
Pistachio Green B	Soluble	-	Starch, soluble	>2	-
Ethyl benzoate	Miscible	-	Stearic acid	2	Miscible
Ethyl alcohol	Miscible	-	Succinic acid	30	-
Ethyl bromide	Miscible	Reacts	Sugar (sucrose)	30	100
Ethyl ether	Miscible	-	Sulfamic acid	40	-
Ethylene dichloride	Miscible	-	Sulfur	-	<1
Formalin (37%)	Miscible	-	Sulfuric acid	Miscible	-
Formamide	Miscible	-	Tallow	Insol.	1.9
Formic Acid	Miscible	-	Tallow amide, hydrogenated (Armour Armide HT)	Insol.	>40
			Tetrahydrophthalic anhydride	50	-
			Thiourea	40	85
			Toluene	Miscible	-
			Toluene di-isocyanate	Miscible	-
			Tributylamine	0.9	-
			Tricresyl phosphate	Miscible	-
			Triethanolamine laurylsulfate	Soluble	-
			Triethanolamine	Miscible	-
			Triethylamine	10	-
			Trinitrotoluene	Soluble	-
			Turpentine	10	-
			Urea	40	110
			Water	Miscible	-
			Xylene	Miscible	-

TABLE VIII
Solubility of Gases in DMSO at Atmospheric Pressure and 20°C
(from pure gases in each case)

	Grams Gas per 100 Grams Solution	Gas Volume per Volume of DMSO
Acetylene	2.99	28.1
Ammonia	2.6	40.0
Butadiene	4.35	-
Mixed butylenes	2.05	-
Carbon dioxide	0.5	3.0
Carbon monoxide	0.01	
Ethylene	0.32	2.8
Ethylene oxide	60.0	306.0
Freon 12	1.8	3.7
Helium	Insol.	
Hydrogen	0.00	
Hydrogen sulfide	0.5 (reacts)	
Isobutylene	2.5-3.0	-
Methane	0.00	
Nitric oxide (NO)	0.00	
Nitrogen	0.00	-
Nitrogen dioxide (NO ₂ , N ₂ O ₄)	Miscible (possible reaction)	0.06
Oxygen	0.01	
Ozone	Reacts	
Sulfur dioxide	57.4 (reacts)	

PART III REACTIONS OF DMSO

1. Oxidation of DMSO

DMSO reacts with strong oxidizing agents to give dimethyl sulfone, $\text{CH}_3\text{SO}_2\text{CH}_3$. Ozone gives a good yield of the sulfone (825)(8923). Both dichromate oxidation (321) and permanganate oxidation (9222) have been used for quantitative determination of DMSO (1612). Aqueous chlorine under acidic conditions gives dimethyl sulfone and methanesulfonyl chloride (1273)(8548), but under alkaline conditions the oxidation is accompanied by chlorination to give an 80% yield of hexachlorodimethyl sulfone (905):

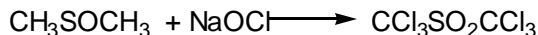

Sodium hypobromite similarly gives a 75% yield of hexabromodimethyl sulfone (229). DMSO reacts with hydrogen peroxide (10224), organic peroxides (1515), or hydroperoxides (8105), particularly in the presence of catalysts (4136), to give the sulfone. It has been reported that the persulfate ion can remove an electron from the sulfur of DMSO to give a radical cation, which is a suitable polymerization catalyst for acrylonitrile (1271). DMSO is also oxidized by peroxydiphosphate (9563) and chloramine-T (9678).

2. Reduction of DMSO

DMSO is reduced to dimethyl sulfide, CH_3SCH_3 , by a number of strong reducing agents, including aluminum hydrides (1024)(1022) and boranes (1138)(3429)(3816)(8885). Mercaptans reduce acidified DMSO and are oxidized to the disulfides (428)(1373)(2532)(2779)(8054)(8095)(8405)(9949):

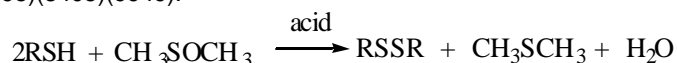

3. Reaction with Metals

The reaction of DMSO with sodium and potassium metals does not lead to simple removal of a hydrogen, but occurs by cleaving the carbon-sulfur bond (206):

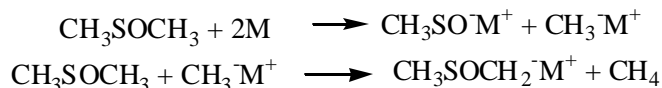

The electrolytic reduction of sodium chloride or sodium iodide in DMSO similarly leads to a mixture of hydrogen and methane gases at the cathode (1508).

4. Reaction with Strong Bases - Dimsyl Ion

Methylsulfinyl carbanion, dimsyl ion, H_2CSOCH_3 .

The activating influence of the sulfinyl group on α -hydrogens is considerably less than that of a carbonyl group but still sufficient to give a pK_a of 35.1 for DMSO (10411). Consequently, strong bases such as sodium hydride or sodium amide react with DMSO to produce solutions of sodium methylsulfinyl carbanion (dimsyl ion) which have proved to be synthetically useful (634):

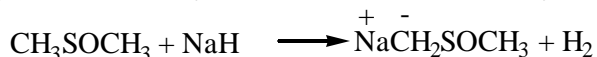

As the base, the dimsyl sodium solution can be employed to remove protons from carbohydrates, amines, amides, acetylenes, weakly acidic hydrocarbons and many other compounds. The dimsyl ion has also been used to prepare salts of carbonyl compounds, and for eliminations producing olefins, aromatics and cyclopropane derivatives. There are numerous applications of the dimsyl ion in the isomerization of alkynes and formation of phosphorus ylides in preparing Wittig reagents.

The dimsyl ion solutions provide a strongly basic reagent for generating other carbanions. The dimsyl ion shows the expected nucleophilicity of carbanions and serves as a source of methylsulfinylmethyl groups (634).

Thus, with alkyl halides or sulfonate esters, sulfoxides are obtained; carbonyl compounds yield β -hydroxysulfoxides and esters give β -ketosulfoxides (624):

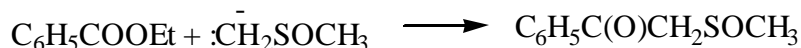
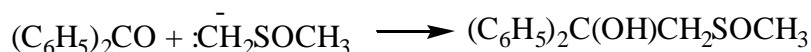
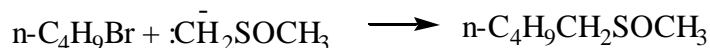

Zinc and sulfuric acid have been used to reduce DMSO (86). Quantitative procedures for determining DMSO have been based on its reduction using stannous chloride and hydrochloric acid (982), or titanium trichloride in dilute hydrochloric acid (272). DMSO is reduced only very slowly with hypophosphorus acid unless catalyzed by dialkyl selenides (1005). Hydroiodic acid reduces DMSO (7073), and the kinetics of the reaction have been examined (84)(85)(1687)(1544). Hydrogen bromide, on the other hand, reduces DMSO only at temperatures about 80°C (1579). DMSO has also been reduced with iodine-sulfur dioxide or bromine-sulfur dioxide complexes (9464), cyclic phosphoranes derived from catechol (9944), silanes (10085)(10127), thiophosphoryl bromide (10139) and other reagents. Quantitative or almost quantitative yields of dimethyl sulfide are claimed in some of these reductions.

The dimsyl ion also adds to carbon-carbon double bonds, and if the mixture is heated for several hours, the initial adduct eliminates methanesulfinic acid. The overall result is methylation and with compounds such as quinoline or isoquinoline, yields are nearly quantitative (202):

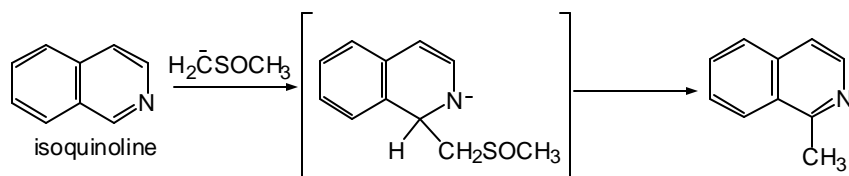

Care is required in running these reactions because the decomposition of the intermediate sulfoxide anion (and also dimethyl sodium) during the heating in the strongly alkaline system is exothermic and also produces a precipitate which can interfere with heat removal. Explosions have been observed which were not detonations but were due to a pressure build-up by an uncontrolled exotherm (8).

5. Reaction with Acid Halides

DMSO has long been known to react with chlorine or acid chlorides, such as sulfur monochloride, S_2Cl_2 , to give chloromethyl methyl sulfide, whereas with sulfuryl chloride, SO_2Cl_2 , only 13% of the chloromethyl methyl sulfide is obtained (720). Aromatic sulfonyl chlorides (463), thionyl chloride (595), and organic acid chlorides also give chloromethyl methyl sulfide (467)(8601). With thionyl chloride, it has been suggested that the reaction, in a simplified form, can be represented as follows:



The reaction in many cases proceeds by way of initial attack of the chlorinating agent upon the oxygen of DMSO, followed by removal of a proton to give an ylide which is finally attacked by chlorine (459):

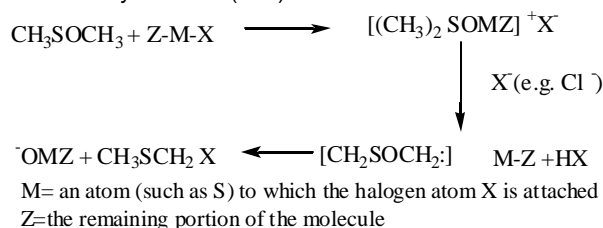

The kinetics of the reaction between DMSO and acetyl chloride has been studied using NMR spectroscopy. The decay of DMSO and acetyl chloride follows mainly 2nd order kinetics. The growth of the main products, acetic acid and chloromethyl methyl sulfide is mainly second order. The overall reaction is complicated by several side reactions, which generate acetoxymethyl methyl sulfide, acetic anhydride and chlorodimethylsulfonium chloride (9773):

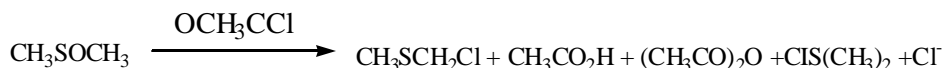

This displacement of a reactive chloride by the DMSO oxygen has been used to introduce hydroxyl groups into compounds that are sensitive toward water (459)(294)(1016)(1383)(3152). Thus, DMSO reacts with cyanuric chloride to give cyanuric acid and with benzoyl chloride to give benzoic acid, (1383):

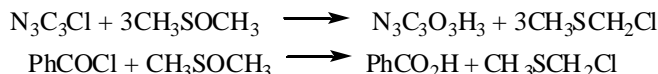

The ability of sulfoxides to react with acid chlorides can be used for the quantitative determination of DMSO. When DMSO is reacted with acetyl chloride in the presence of iodide the following reaction, involving formation of the acyloxysulfonium salt, can be represented as follows:

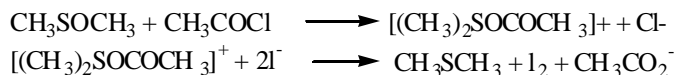

The iodine is then titrated with sodium thiosulfate (1805).

The reaction of DMSO with reactive acid chlorides is vigorous and exothermic and should be conducted with care (669)(8601)(10470).

6. Reaction with Acid Anhydrides

Carboxylic acid anhydrides react with DMSO in a manner similar to that of acid halides. With acetic anhydride, the final product is acetoxymethyl methyl sulfide, $CH_3CO_2CH_2SCH_3$ (290)(291). Several mechanisms of the reaction, the Pummerer rearrangement, have been proposed. There seems to be little doubt that the first step in the reaction of DMSO with acetic anhydride is the formation of the acyloxysulfonium salt (2643)(2896). Various possible pathways of the rearrangement from the sulfonium salt have been proposed, but

the one going through the ylide seems likely (2643)(4820). The Pummerer rearrangement can then be represented by the following reactions

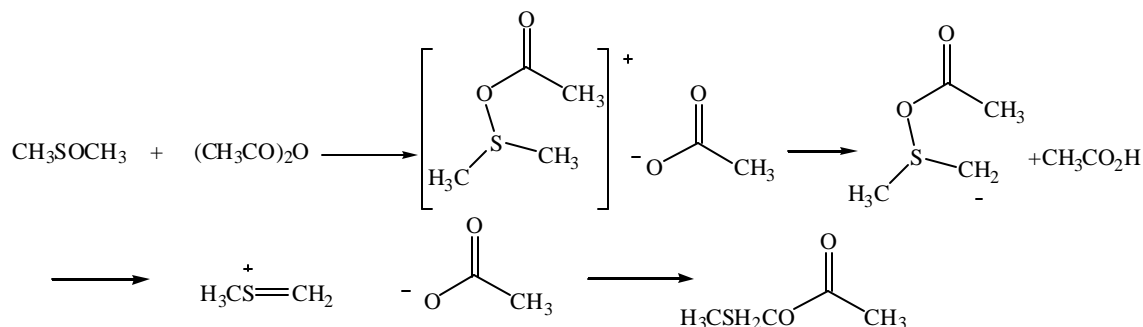

DMSO also reacts with trifluoroacetic anhydride to give the acetoxy-sulfonium salt. When this intermediate is reacted with aromatic amines, amides or sulfonamides the corresponding iminosulfuranes are obtained (7044). When aliphatic carboxylic acids are treated with DMSO activated by tert-butylbromide in the presence of NaHCO₃ the corresponding methylthiomethyl esters are obtained in a Pummerer like reaction (10032). A Pummerer type rearrangement is also suggested in the reaction of diphenylphosphinic anhydride-DMSO reaction (4128):

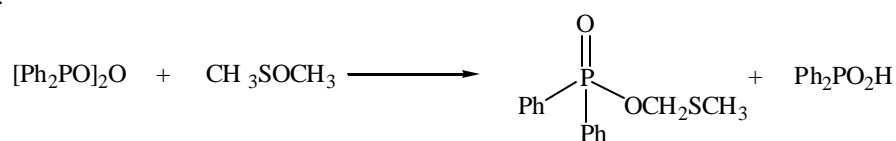

Inorganic anhydrides also attack the DMSO oxygen. The sulfur trioxide-DMSO complex reacts easily with cellulose to give cellulose sulfate esters with a high degree of substitution (1474).

Reactions of DMSO with some acid anhydrides, both organic and inorganic, can be vigorous and should be conducted with care. Thus, acetic anhydride and benzoic anhydride react with DMSO even at room temperature (290), although higher temperatures, e.g. 85-90° C, are needed for faster reactions (7613).

Complex formation between DMSO and sulfur trioxide is an exothermic reaction. To avoid overheating with consequent darkening and violent boiling of the mixture, sulfur trioxide should be added slowly to a cool well stirred and cooled DMSO (1474). DMSO cannot be dried with phosphorus pentoxide because this may lead to an explosive mixture (354).

7. Halogenation of DMSO

DMSO can be halogenated with chlorine or bromine in the presence of a base. Thus, stirring a solution of DMSO, pyridine, and bromine in chloroform results in the formation of bromomethyl methyl sulfoxide (3148):

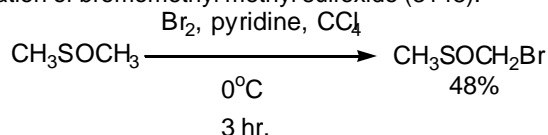

Similarly, bubbling chlorine into a DMSO, pyridine and methylene chloride solution at 0° C for over 30 minutes produces chloromethyl methyl sulfoxide in a 77% yield (6268).

Chlorination of DMSO in the presence of triethylamine yields chloromethyl methyl sulfoxide. Further chlorination in the presence of pyridine yields methyl trichloromethyl sulfoxide (4802):

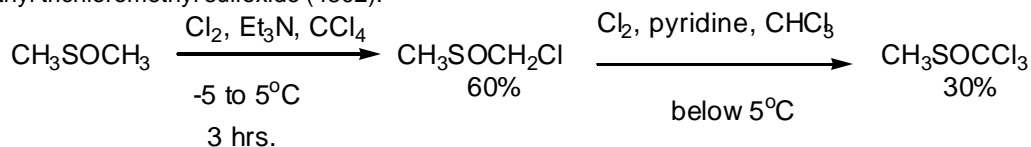

Bromination of DMSO with elemental bromine leads to the formation of trimethylsulfonium bromide. Methanesulfonic acid, paraformaldehyde, dimethyl disulfide, and hydrogen bromide are formed as by-products (4802):

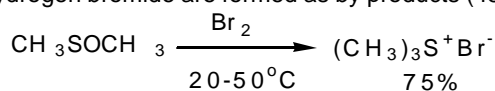

A small amount of hydrogen halides or halogens, especially bromine or hydrogen bromide, catalyze the decomposition of DMSO in the absence of a base. This catalytic decomposition takes place sluggishly. The reaction of bromine proceeds via the initial α-bromination to afford α-bromomethyl methyl sulfoxide which is oxidized (Kornblum reaction) to afford the products listed above [(4802)]. These consecutive reactions form an oxidation-reduction cycle between Br₂-HBr and DMSO-dimethyl sulfide (8400).

8. Reaction with Phenols and Aniline

a) Acid chloride or hydrogen chloride catalysis.

When a solution of phenol in DMSO is treated with an acid chloride, such as thionyl chloride, or saturated with hydrogen chloride, the initially formed adduct of DMSO reacts by electrophilic attack on the phenol to form the sulfonium salt. The sulfonium salt can be decomposed by heating to give hydroxyaryl methylthioethers (2075)(302)(296):

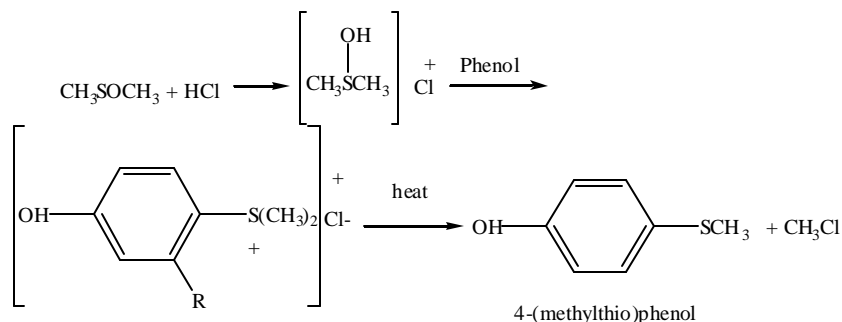

Up to 60% yields are obtained, depending on the structure of the phenol. p-Hydroxyaryl methylthioethers are also obtained when phenols are suspended in 70% perchloric acid and DMSO is added, followed by heating of sulfonium salts in hot, saturated potassium chloride solution (1268):

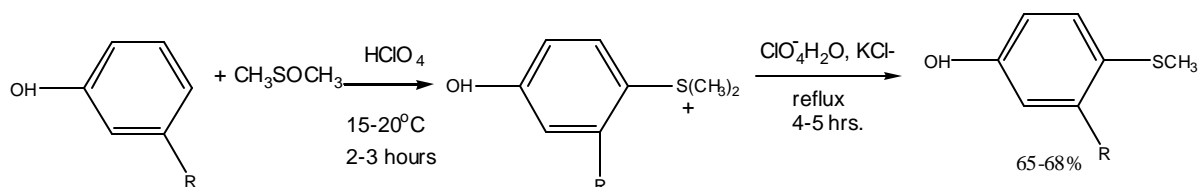

Similarly, hydroxyaryl thioethers can be prepared by reacting phenols with DMSO in sulfuric acid, and heating the crude reaction mixture with aqueous sodium chloride (6335) (6674)(6613).

N,N-dimethylaniline can be reacted with DMSO using phosphoryl chloride catalysis. However, the yield of the aryl thioether is lower in this case (348). Other aromatic amines and hydrazine derivatives also react with DMSO and dicyclohexylcarbodiimide (4651).

b) Dicyclohexylcarbodiimide or acid anhydride catalysis

The reaction of phenols with DMSO and dicyclohexylcarbodiimide in the presence of phosphoric acid or pyridinium trifluoroacetate affords a mixture of the products consisting mainly of 2-methylthiomethyl phenol and 2,6-bis(methylthiomethyl)phenol (540)(1234)(4898)(4891). It has been suggested that the mechanism proceeds according to the following steps (540)(1234)(4898):

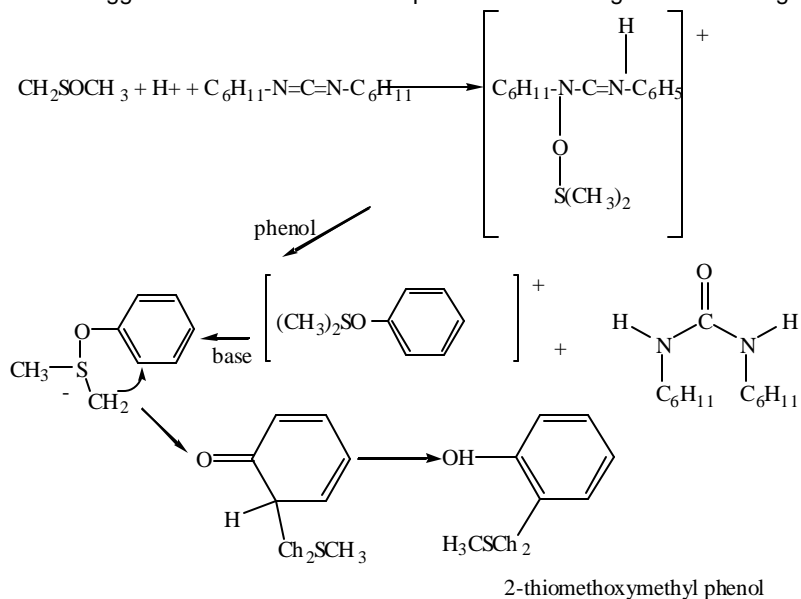

A similar reaction takes place when acetic anhydride (849)(1055) or the pyridine-sulfur trioxide complex (4636) is used to polarize the DMSO molecule instead of dicyclohexylcarbodiimide.

Finally, it has been found that phenols can be methylthiomethylated by boiling with excess DMSO. A mixture of isomeric methylthiomethylation products are obtained, but o-methylthiomethylation is preferred (4636)(4772).

9. Alcohol Oxidation with DMSO

A breakthrough in the preparation of carbonyl compounds from alcohols has been achieved with the development of reagents based on

DMSO (8551)(1503)(4820)(16359).

Several procedures have been developed which permit the selective oxidation of structurally diverse primary and secondary alcohols to the corresponding carbonyl compounds, i.e. aldehydes and ketones, respectively. Most of these reactions take place at room temperature or above. Nucleophilic attack occurs on the DMSO sulfur atom. Most reactions in which the nucleophilic attack takes place on sulfur are aided by prior electrophilic attack on the oxygen atom (10720):

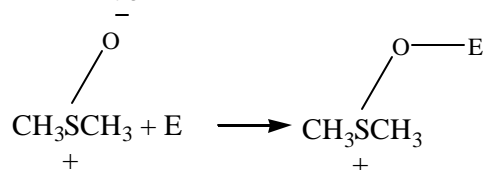

The electrophilic reagents which activate DMSO include acetic anhydride, trifluoroacetic anhydride, and other acid anhydrides, the sulfur trioxide-pyridine complex, thionyl chloride, oxalyl chloride, acetyl chloride, and other, acid chlorides, bromine, chlorine, t-butyl hypochlorite, dicyclohexylcarbodiimide, and others.

The labile intermediate, the DMSO-electrophile complex, can now be attacked by a nucleophile, such as an alcohol, to perform a displacement on sulfur with oxygen as the departing group:

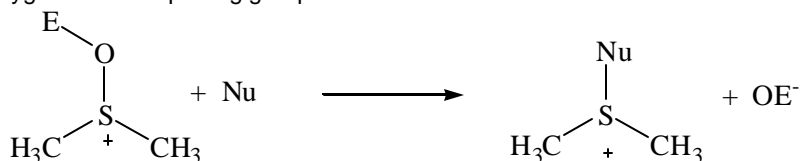

Several of the above-mentioned activating agents and their use in the oxidation of alcohols are described below.

a) Acetic anhydride

In this procedure an alcohol is treated with a mixture of acetic anhydride and DMSO at room temperature (1127) (9926). DMSO first reacts with acetic anhydride to form the acyloxysulfonium salt which in turn reacts with the alcohol to give the alkoxydimethylsulfonium intermediate which decomposes to the carbonyl compound and dimethyl sulfide (DMS)(1127):

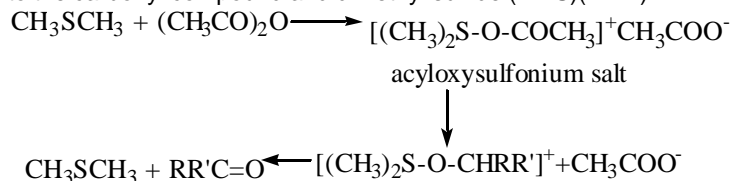

A number of side reactions take place when using the acetic anhydride-DMSO procedure. The usual side products are acetates and methylthiomethyl ethers, RR'CHOCH₂SCH₃. The advantage of the acetic anhydride-DMSO method is the fact that highly hindered alcohols, which would be inert to other DMSO-activator systems, are oxidized (4820).

b) Trifluoroacetic anhydride

Trifluoroacetic anhydride and DMSO react exothermally at -60° C. in methylene chloride to produce a white precipitate, presumably an ion pair, trifluoroacetoxydimethylsulfonium trifluoroacetate.



This reacts rapidly with alcohols, even sterically hindered ones (e.g. 2-adamantol and neopentyl-type alcohols) to give the corresponding carbonyls (7943)(8455). Trifluoroacetic anhydride is an excellent activator for DMSO because of short reaction times and high yields of carbonyl compounds with minimal by-product formation. The major drawback is the need to work at very low temperatures (-30 to -60° C) (10720).

c) Dicyclohexylcarbodiimide

This method of oxidation is generally referred to as the "Pfitzner-Moffatt" technique, after its originators (1503). The reaction involves addition of an alcohol substrate to a solution of dicyclohexylcarbodiimide (DCC) in DMSO with an acid, such as phosphoric acid or pyridinium trifluoroacetate (172), present as a proton source. This results in reaction conditions near neutrality at room temperature. The oxidation technique is applicable to primary or secondary alcohol groups in an almost unlimited variety of compounds, including alkaloids, steroids (173), and carbohydrates (4349). Steric effects are not important except in highly hindered systems (1503). In the reaction, the DMSO molecule is first converted to a labile intermediate which is susceptible to attack at the sulfur by an alcohol group to produce an alkoxy-sulfonium salt which undergoes base-catalyzed decomposition to the carbonyl compound (3049):

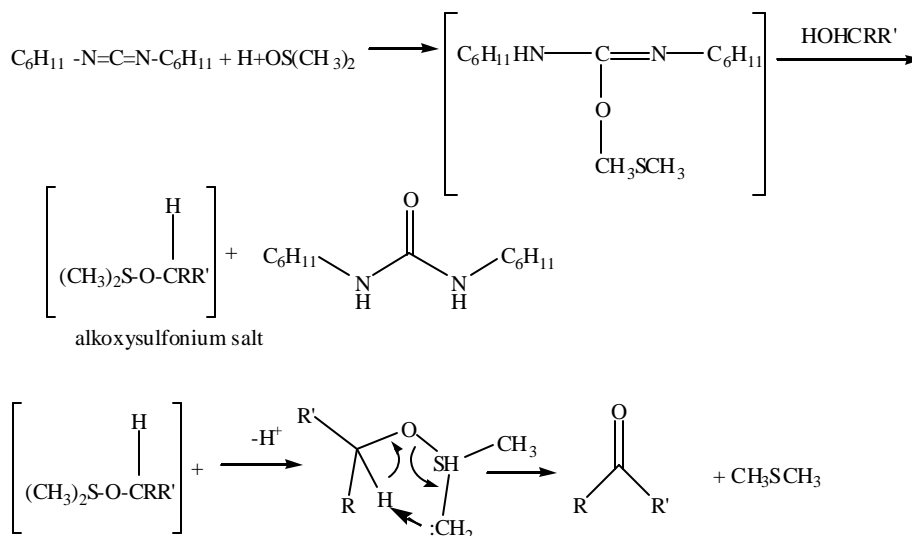

Protecting groups such as isopropylidene, benzylidene, acetate, benzoate, and sulfonate esters and ethers are stable in the conditions used for oxidation (3602)(175).

d) Phosphorus pentoxide

It has been found that DMSO containing phosphorus pentoxide rapidly oxidizes the alcoholic groups of carbohydrates and other compounds at room or elevated temperatures to the corresponding aldehydes or ketones (208). In general, oxidations proceed most efficiently in the presence of 3-4 molar equivalents of DMSO and 1.2-2.0 molar equivalents of phosphorus pentoxide (2327). The carbohydrate oxidation with DMSO-P4O10 should be run at about 60-65°C. This system catalyzes carbohydrate polymerization at temperatures below 35°C (5296) (6079). DMSO, DMF and pyridine seem to be the best solvents for this reaction (3602)(2327)(6691).

e) Sulfur trioxide-pyridine

The combination of DMSO with SO₃-pyridine complex in the presence of triethylamine yields a reagent that rapidly oxidizes primary and secondary alcohols in good yield at room temperature to aldehydes and ketones, respectively (9926)(10720). An attractive feature of this reagent is its property of effecting oxidation of allylic alcohols to the corresponding α, β-unsaturated carbonyl compounds (1752). The SO₃-pyridine complex in DMSO can be used to oxidize acid-labile trans-diols (4037) or cis-diols (8033) to quinones. This reagent has also been used to oxidize alkaloid hydroxyl groups to ketone groups (2749)(8017). Application of the DMSO-SO₃-pyridine reagent to partially acetylated carbohydrates leads to oxidation as well as elimination of the elements of acetic acid, thus providing a high yield to novel unsaturated carbohydrates (2652):

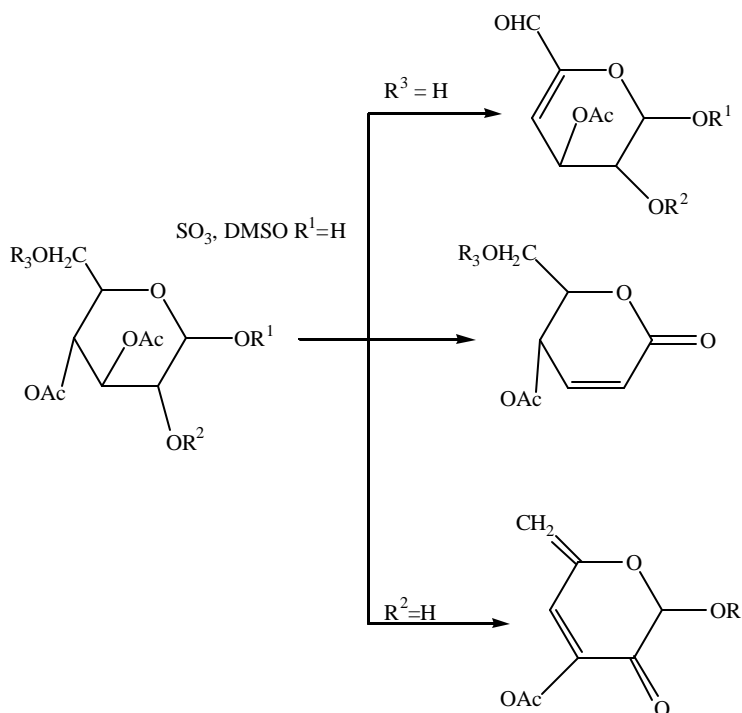

f) Oxalyl chloride

Oxalyl chloride is an efficient and useful activator, superior to trifluoroacetic anhydride, for the conversion of alcohols to their alkoxy-sulfonium salts which, upon basification, result in generally higher and frequently quantitative yields of the corresponding carbonyl compounds (9786)(9926). The unstable intermediate formed at low temperatures (usually -60° C) instantaneously loses carbon dioxide and carbon monoxide. The new intermediate is the same as that proposed for the dimethyl sulfide-chlorine reagent. This product has been reacted with a wide variety of alcohols to convert them to the carbonyl compounds (10084):

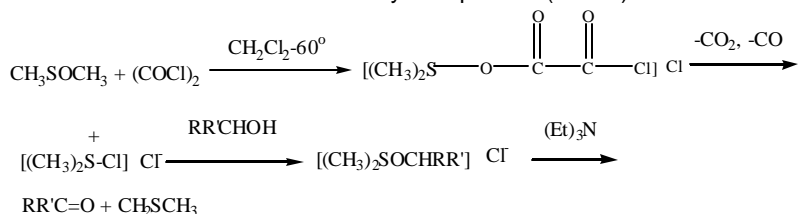

10. Kornblum Reaction

Kornblum and co-workers have demonstrated that in DMSO α -bromoketones at room temperature and primary alkyl tosylates on heating afford the corresponding carbonyl compounds, presumably through an oxosulfonium intermediate (273)(8551):

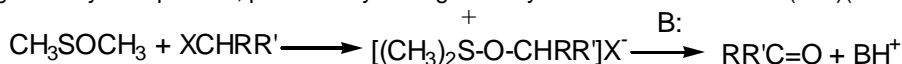

Some reactive alkyl halides, such as methyl iodide, also react with DMSO to form the oxosulfonium intermediate (the O-alkyl derivative). However, this intermediate rearranges readily to the more stable oxosulfonium salt, i.e. $(\text{CH}_3)_3\text{S}^+\text{O}^-$, and no oxidation takes place (324). Some reactive halides, such as benzyl, can also be oxidized to the corresponding carbonyl compounds but higher reaction temperatures are necessary. An acid acceptor, e.g. sodium hydrogen carbonate, is frequently used (105). The relatively unreactive alkyl halides, such as 1-chloroheptane, can be oxidized by DMSO if the chloride is first converted to the tosylate (106).

The DMSO oxidation of the primary allylic chloride, 4-chloro-3-methyl-2-buten-1-yl acetate, does not proceed well when sodium hydrogen carbonate is used as the acid acceptor. However, this reaction runs well when a dibasic metal phosphate, Na_2HPO_4 or K_2HPO_4 , is used (9960):

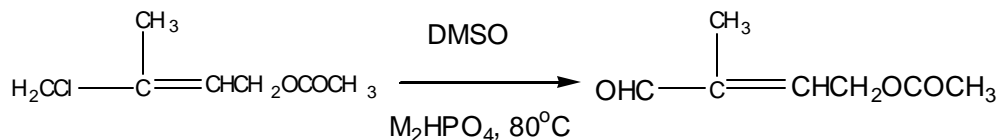

This particular reaction is catalyzed by sodium bromide (9960)(10066).

11. Methoxydimethylsulfonium Salts and Trimethyloxosulfonium Salts

Alkylating agents, such as methyl iodide, react initially with DMSO at the oxygen to give methoxydimethylsulfonium iodide (see the previous section, Kornblum Reaction). These alkoxy-sulfonium salts are quite reactive and with continued heating either decompose to give the carbonyl compounds or rearrange to the more stable trimethyloxosulfonium salts. In the case of methyl iodide trimethyloxosulfonium iodide is produced (324):

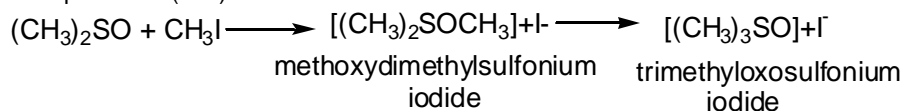

Trimethyloxosulfonium iodide is of interest because treatment with sodium hydride or dimethyl sodium produces dimethyloxosulfonium methylyde which is an excellent reagent for introducing a methylene group into a variety of structures (632)(2463)(4820):

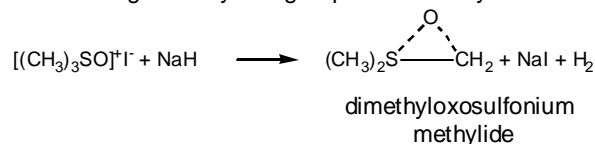

Many aldehydes and ketones react with the ylide to give better than 75% yields of epoxides (632):

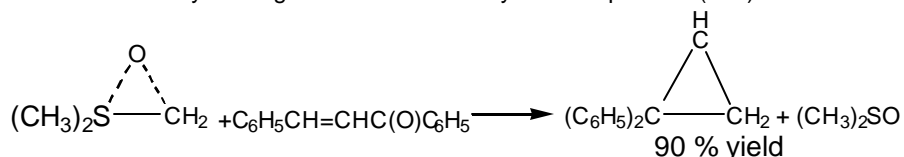

In a similar case, the dimethyloxosulfonium methylyde reacts with carbon-carbon double bonds that are conjugated with carbonyl groups to give cyclopropane derivatives (4820)(7361):

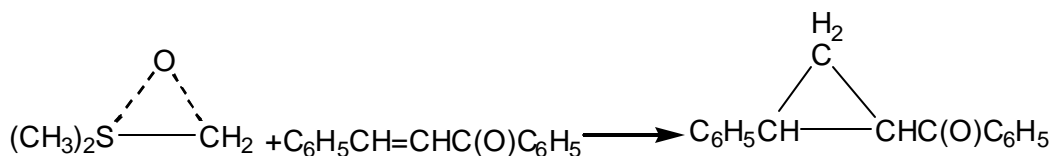

PART IV. DMSO AS A REACTION SOLVENT

A. DISPLACEMENT REACTIONS IN DMSO

These are reactions in which reactive groups are replaced by nucleophilic ions or molecules.

The largest category of reactions in which DMSO has been used as a solvent is that in which labile groups are replaced by nucleophilic ions or molecules. The reason for the particular utility of DMSO in these reactions has not always been established and derives from a number of factors. DMSO as one of the most polar of the common aprotic solvents. It is a favored solvent for displacement reactions because of its high dielectric constant and because anions are less solvated in it (9488). The high dielectric constant of a solvent insures that dissolving species or a solute bearing opposite charges do not come together to agglomerate. E.g. when sodium hydroxide is dissolved in DMSO, the interaction between Na⁺ and OH⁻ is minimized. Due to the polarity of the sulfoxide bond and the electron density at the oxygen, cations are much more solvated by DMSO than the anions. Conversely, the aprotic nature of DMSO precludes the solvation of anions by hydrogen bonding so that these are solvated only by dipolar attraction and thereby are more reactive. In other cases, the controlling influence is suggested to the ability of highly polar DMSO molecules to stabilize transition state structures and thereby lower the activation energy (22) (471)(399). This latter effect is evident in the cases where comparatively minor additions of DMSO cause significant enhancement of reaction rates (1262).

A great variety of displacement reactions can be run in DMSO and suitable nucleophiles include:

1. Acetylide ion
2. Alkoxide ion
3. Amides
4. Amines
5. Ammonia
6. Azide ion
7. Carbanions
8. Carboxylate ion
9. Cyanate ion
10. Cyanide ion
11. Halogen ion
12. Hydroxide ion
13. Mercaptide (or Thiophenoxide) ion
14. Nitrite ion
15. Phenoxide ion
16. Sulfide (or Hydrosulfide) and Thiosulfate ions
17. Thiocyanate ion

1. Acetylide ion

The usual reactions of sodium acetylide may be accomplished in good yield by stirring a slurry of sodium acetylide in DMSO slightly below room temperature with reagents such as alkyl halides, epoxides or carbonyl compounds (544). Displacement of halides with the ethylene-diamine complex of lithium acetylide is also easily effected in DMSO (3178)(4175). Thus, the reaction of 1-bromo-5-chloropentane with lithium acetylide-ethylene diamine complex in DMSO gives 7-chloro-1-heptyne (1826):

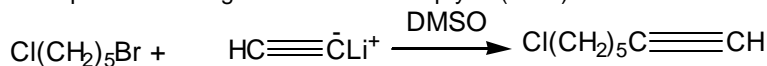

The use of lithium acetylide-ethylene diamine in DMSO has given higher yields of the desired products than sodium acetylide in liquid ammonia (4175).

The addition of lithium acetylide as the ethylene-diamine complex to 7-bromoheptanol tetrahydropyranyl ether in DMSO gives non-8-yn-1-ol tetrahydropyranyl ether in higher than 90% yield (4333).

2. Alkoxide ion

The high activity of alkoxide ions in DMSO shows up in their enhanced basicity. The basicity of alkoxides reaches a maximum in DMSO when the mixture is substantially free of hydroxylic material. In this case, the acidity of the alcohols in dilute solutions is about 10³ times that of DMSO so that only a minor equilibrium quantity of the DMSO anion is present (734). The reactivity of the alkoxide ion in DMSO is influenced by the cation and is greater with cesium and with lithium less (606)(1162). The vastly enhanced activity of alkoxide ions in DMSO over their activity in alcohols is attributed to the absence of alkoxide-solvent hydrogen bonds in DMSO which are present in the hydroxylic solvents (434).

The basicity of alkoxides in DMSO is conveniently expressed in terms of acidity functions, and a number of these are plotted in Figure 10 for bases in DMSO-water and DMSO-methanol systems.

Alkoxides differ in their solubilities in DMSO. Thus, potassium t-butoxide is more soluble than some lower alkoxides (17). The solubilities of these hydroxylic bases are also shown in Table IX for comparative purposes.

A review article on potassium t-butoxide and its use in nucleophilic displacements has been published (6815).

TABLE IX Solubilities of Various Bases in DMSO

Substance	moles/liter	Reference
-----------	-------------	-----------

NaOH	7.6×10^0	(725)
KOH	1×10^3	(17)
(CH ₃) ₂ NOH	1×10^1	(17)
NaOCH ₃	1.6×10^3	(725)
NaOEt	2×10^2	(17)
iso-PrONa	7×10^3	(17)
n-BuONa	5×10^3	(17)
t-BuOK	1×10^2	(17)

a) Aliphatic halide displacement

The rate of reaction of alkoxide ions with alkyl halides in alcohol-DMSO mixtures to form ethers increases with the increasing amount of DMSO. This is illustrated in the reaction of methyl iodide with methoxide ion or with ethoxide ion to make dimethyl- or methyl ethyl ethers, respectively (329), and in the reaction between benzyl chlorides and methoxide ion to make the corresponding benzyl methyl ethers (433). The rate increase at high DMSO concentrations is attributed to an increased activity of the methoxide ion caused by reduced solvation, but other factors are probably more important at low DMSO concentrations. The activation energy decreases continuously as the DMSO concentration increases (433). The Williamson ether synthesis from alcohols and alkyl halides (chlorides) with sodium hydroxide as the base can be considerably improved by using DMSO as the solvent in place of the excess alcohol (2924):

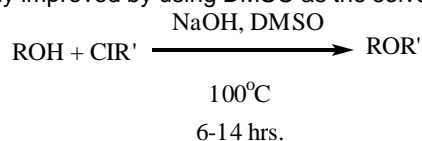

Secondary alkyl chlorides and primary alkyl bromides give little etherification, elimination being the major reaction.

The use of alkoxides in DMSO in some cases involves elimination in addition to displacement, followed by the addition of the alkoxide to the double bond in alicyclic compounds (1798).

b) Aromatic halide displacement

As with alkyl halides, the use of alkoxides in DMSO can involve both the displacement and elimination reactions with aromatic halogen compounds. Thus, when a solution of 3-bromo-tropolone in DMSO is heated with sodium methoxide, an almost 1:1 mixture of 3-methoxytropolone and 4-methoxytropolone is obtained in 96% yield (3572):

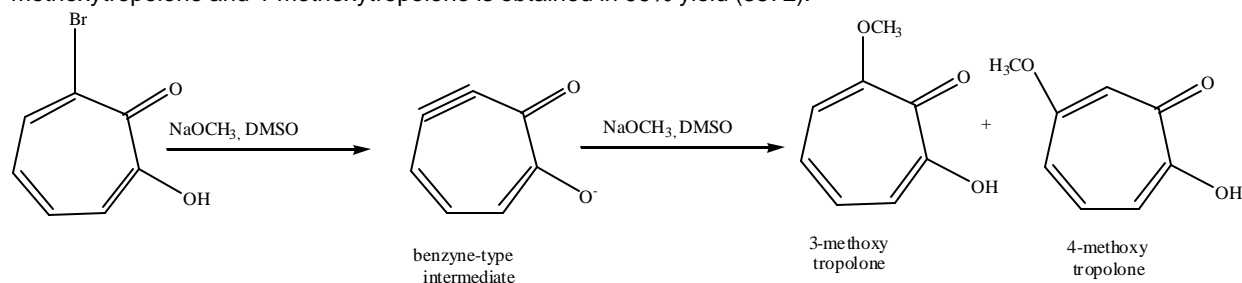

Aromatic halogens in nitroaryl halides can be displaced by the methoxide ion in DMSO-methanol. The reaction rate increases some 1000-fold when the DMSO concentration is increased to 80% (399):

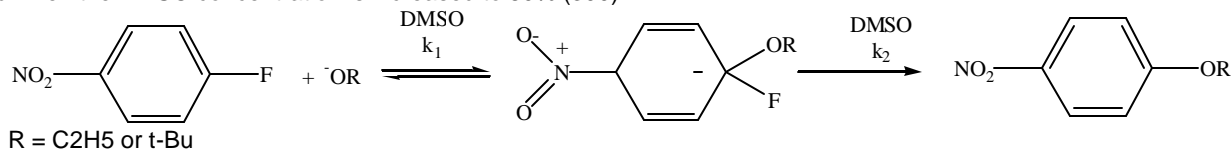

p-Nitrochlorobenzene also reacts with alkoxides. When 2-alkylamino-ethanol is first treated with dimethyl sodium to make the oxyanion base followed by the addition of p-nitrochlorobenzene, the preferential nucleophilic attack by oxygen (rather than the amino group) is insured (8399):

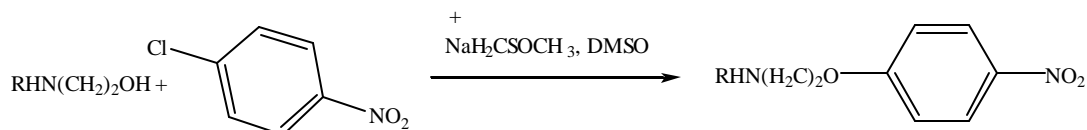

The reaction of monoiodo-, monobromo-, monochloro- and monofluoro-naphthalenes with potassium butoxide in butyl alcohol-DMSO has been examined (4058)(4059). The major products observed in the bromo-, iodo- and chloronaphthalene reactions are 1- and 2-butyl naphthyl ethers, 1- and 2-naphthols and 1-methylmercapto-2-naphthol. This suggests that 1,2-dehydronaphthalene is an intermediate in each of these reactions, and 1-methyl-mercapto-2-naphthol is probably the benzyne intermediate-DMSO reaction product (4059). The

fluoronaphthalenes undergo only direct nucleophilic substitution with no formation of 1,2-dehydronaphthalene, i.e. no benzyne-type intermediate (4058)(5244):

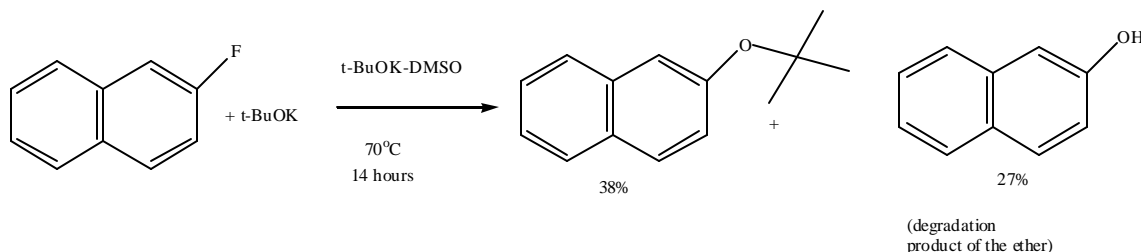

2,3-Dichloranisole can be prepared by reacting 1,2,3-trichlorobenzene with sodium methoxide in DMSO-methanol (9107).

The kinetics of the reaction of 2-bromo-, 2-bromo-3-methyl-, and 2-bromo-5-methylpyridine and methoxide ion in DMSO containing small amounts of methanol have been determined (2125). The ortho:para ratio is higher at lower temperatures (2.5 at 40° C vs 1.44 at 110° C):

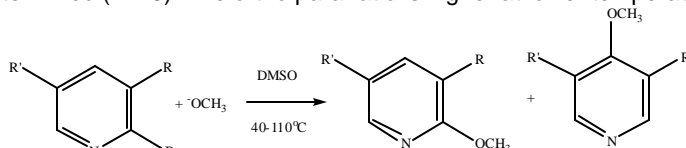

2-Bromopyridine reacts with potassium methoxide in DMSO containing 1% of methanol 3000 times faster than it does with the same reagent in pure methanol at 110°C.

A number of 4-alkoxy pyridines is prepared by reacting 4-chloropyridine with sodium alkoxides in DMSO in moderate to high yields (5038).

5-Bromo-3-methyl-4-nitroisothiazole reacts smoothly with sodium alkoxides in alcohols-DMSO to give the appropriate 5-alkoxy-3-methyl-4-nitroisothiazoles (4098):

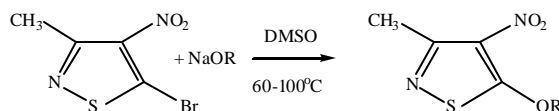

c) Nitro group displacement

When sodium methoxide or sodium ethoxide is added to p-nitro- or p,p'-dinitrobenzophenone in DMSO, almost quantitative yields of p-alkoxy- or p,p'-dialkoxybenzophenone are obtained (470):

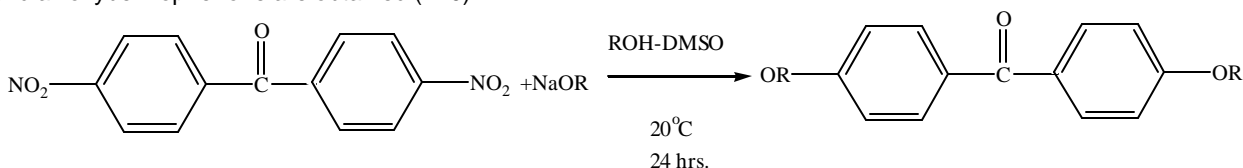

Sulfonamides are also alkylated in DMSO. 4,6-Dichloropyrimidine reacts with the sodium salt of p-nitrobenzenesulfonamide in DMSO to give 4-chloro-6-(p-nitrobenzenesulfonamido)pyrimidine (42):

With 2,2'-dibromo-4,4'-dinitrobenzophenone, there is no displacement of bromide ion, and 2,2'-dibromo-4,4'-dimethoxybenzophenone (90%) is obtained. No reaction occurs in any instance when dioxane is used instead of DMSO (470).

d) Sulfinate displacement

When β-styrylsulfones are treated with one molar equivalent of sodium alkoxides in DMSO, β-alkoxystyrenes are formed by nucleophilic substitution (9761):

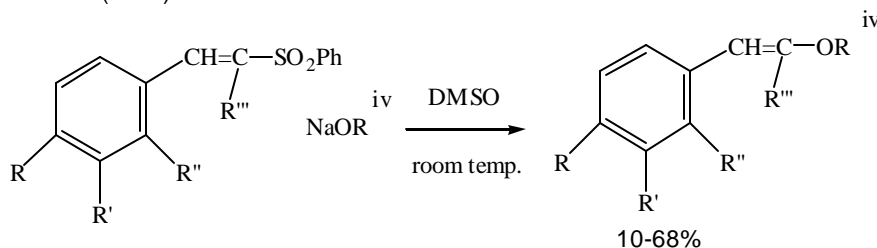

e) Sulfonate displacement

Benzene sulfonates of common primary and secondary alcohols react rapidly with sodium methoxide in DMSO to give high yields of alkyl methyl ethers and/or alkenes. The ether-alkene ratio is significantly higher in reactions with sodium methoxide than with potassium t-butoxidesulfonate groups from carbohydrate derivatives, the conversion to the ether with sodium methoxide or sodium e. More olefins are formed from secondary sulfonate esters than from primary esters (580)(592). In the displacement of methoxide in DMSO occurs by the attack on the sulfur, leading to the retention of configuration, rather than by the usual attack on carbon with inversion (1119)(653).

3. Amides

The N-alkylation of amides can take place in DMSO. The reaction of various α -haloamides with the dimethyl ion in DMSO can be used to obtain good to high yields of 4-, 5- and 6-membered lactams. However, the reaction with dimethyl ion fails to produce the seven-membered heterocyclic ring (888):

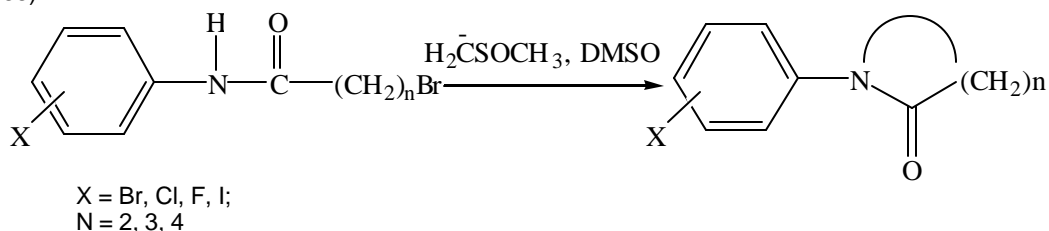

The readily available base, dimethyl ion, could be more convenient to work with than sodium in liquid ammonia (888). The alkylation of the sodium salt of saccharin with a benzyl chloride also proceeds well in DMSO to give a high yield of N-benzyl saccharin (947): 7-Oxo-7,8-dihydro-s-triazolo[4,3-a]pyrimidine can be alkylated as above using p-chlorobenzyl chloride in DMSO. In this case, however a mixture of the N-benzyl- and the O-benzyl derivatives results (3885):

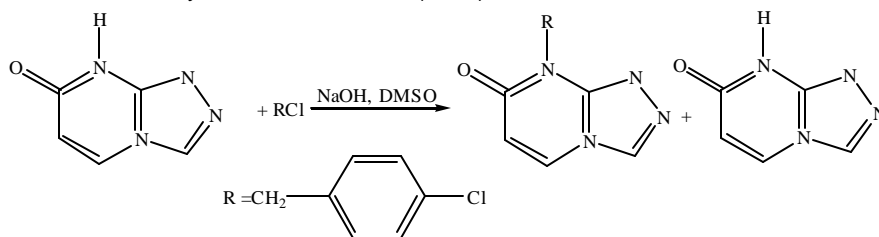

It has been found that the N-alkylation of carboxylic acid amides proceeds well in DMSO by using dry potassium hydroxide as the base. Good yields can be obtained even at room temperature (4355):

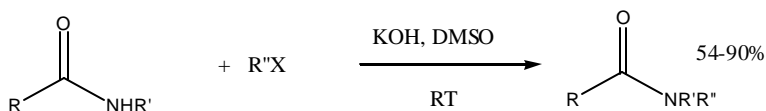

With DMSO as the solvent, the use of stronger bases, such as sodium hydride or potassium alkoxides, is not necessary. When the sodium salt of an acetamidonitrile in DMSO is treated with chloramine, a smooth N-amination is achieved (4382):

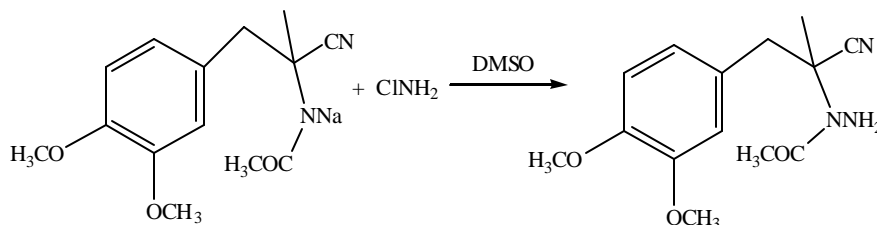

Peptides and proteins can also be N-alkylated with methyl iodide and benzyl bromide using DMSO as the solvent and the dimethyl ion as the base (4945).

A number of amides, such as acetanilide, have been N-alkylated with dialkyl sulfates using potassium hydroxide as the base and DMSO as the solvent (8276):

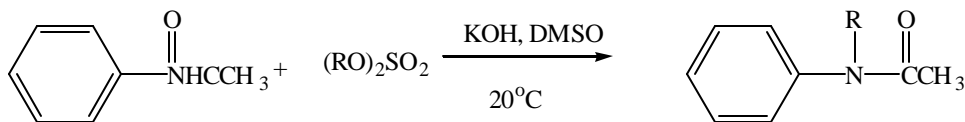

The sodium salt of an amide can displace a methoxy group from a benzene nucleus. Thus, the treatment of 2-acetamido-2'-methoxybenzophenone with sodium hydride in DMSO gives the 9-acridone (8564):

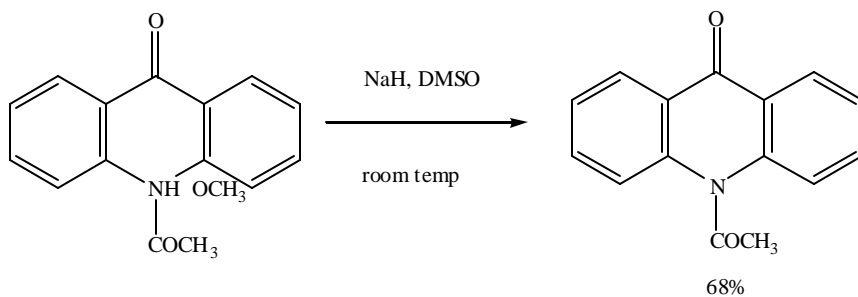

4. Amines

In most displacement reactions, the nucleophiles are negatively charged. However, displacements can also take place involving uncharged nucleophiles, namely, amines (3433). Amines, like ammonia, do not hydrolyze DMSO. The presence of DMSO in the displacement reaction involving amines allows the reagents to surmount the energy barrier easier than in hydroxylic solvents, irrespective of the charge type of the reagents. The effect of DMSO, then, must be the decrease in the energy of the transition state. It could also be said that DMSO polarizes a substrate (399). For a reaction involving neutral reactants, such as amines, and going through a charged transition state, it appears that DMSO can solvate the cationic part of the reacting system at the point of attack of the amine reagent (1240). Thus, displacement reactions by amines in DMSO generally proceed at a good rate. A catalytic effect is seen by adding DMSO to an alcohol system containing amines and aryl halides (399)(1262).

a) Aliphatic halide displacement-primary amines

Alkylation of weak aromatic amines with alkyl bromides (e.g. 2-aminofluorenone with ethyl bromide) in DMSO gives ring brominated N-alkyl derivatives (211). However, arylation of 2-aminofluorenone with aralkyl bromide, such as benzyl- and para-substituted benzyl bromides in DMSO leads to azomethines as the main products (264):

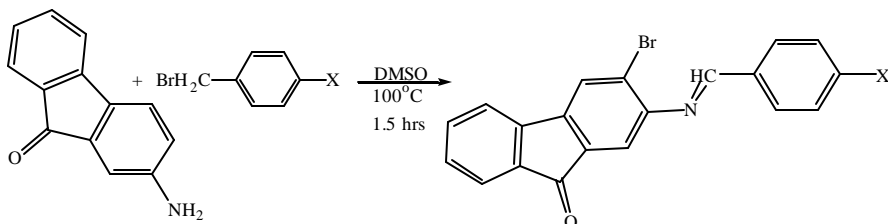

DMSO also catalyzes the reaction between 2-substituted carboxylic acids and amines. Thus, ethylenediamine reacts with chloroacetic acid to give ethylenediaminetetraacetic acid (EDTA) (4910):

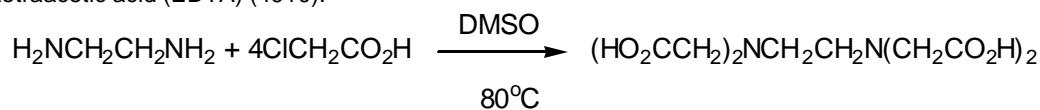

b) Aliphatic halide displacement-secondary amines

? -Bromoalkylbenzofuranones react with morpholine in DMSO to give high yields of the N-alkylation products (613):

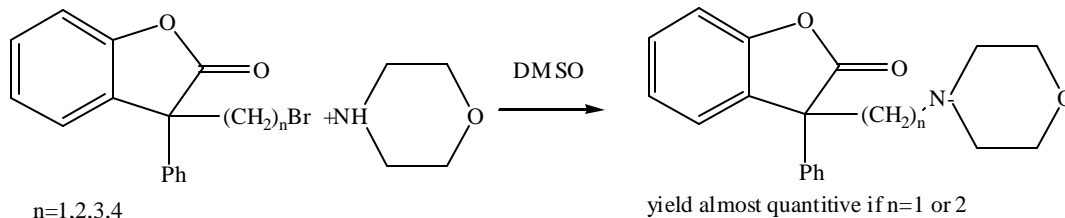

The morpholinoethylbenzofuranone is formed by direct halogen displacement and no rearrangement reactions take place.

c) Aliphatic halide displacement-tertiary amines

The reaction between triethylamine and ethyl iodide has been investigated in benzene, DMSO and various benzene-DMSO mixtures. The reaction rate increases with increasing DMSO concentration in the solvent. Although DMSO reacts slowly with alkylating agents, quaternizations, such as the reaction of triethylamine and ethyl iodide, proceed much more rapidly to give a high yield of tetraethylammonium iodide (585):

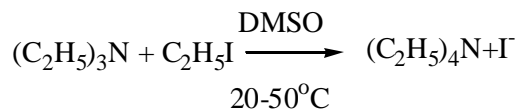

Similarly, when p-nitrocumyl chloride is treated with quinuclidine in DMSO, a 90% yield of pure quaternary ammonium chloride can be isolated (3433):

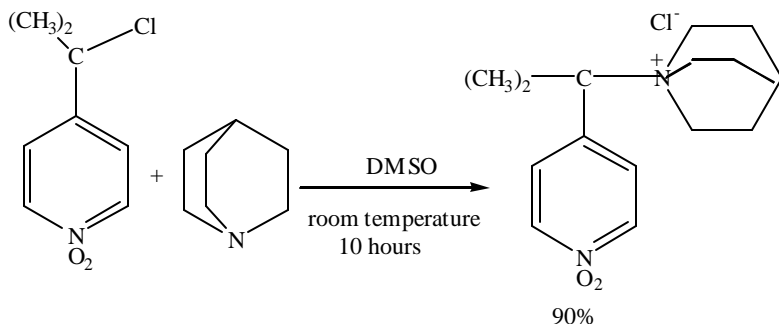

d) Aromatic halide displacement - primary amines

A series of primary amines has been reacted with 4-nitrofluorobenzene in DMSO to determine the rate constants. DMSO was selected as the solvent because of its relatively high boiling point and the fact that most nucleophilic reactions in DMSO proceed at a fast rate (1638). These reactions are run in the presence of an excess of amines:

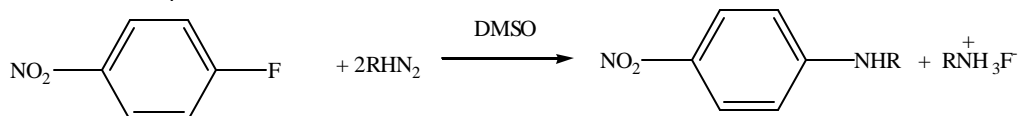

Similarly, benzylamine reacts with 2,4-dinitrochlorobenzene (399):



e) Aromatic halide displacement - secondary amines

The displacement of aromatic halides by secondary amines in DMSO has been studied rather extensively. The fluoro compounds undergo substitution by various nucleophiles, such as secondary aliphatic and alicyclic amines, at rates 100 to 1000 times faster than their chloro analogs. The rate of displacement of fluorine is further enhanced by the order of 10³ to 10⁵ in dipolar aprotic solvents, such as DMSO, as compared with reactions in aprotic solvents (471). Thus, 4-fluoroacetophenone undergoes a very rapid displacement of the halogen by amines, such as morpholine, in DMSO and affords in high yields the corresponding 4-amino derivatives, which are otherwise difficult to prepare (398):

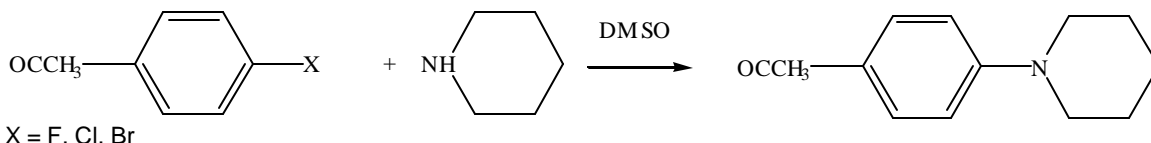

The yields of products obtained in DMSO are higher than those obtained with DMF under comparable conditions.

The reaction of 2,4-dinitrochlorobenzene with piperidine, which is known to be insensitive to base catalysis, is nevertheless accelerated by DMSO (538).

The rate constants for the reaction of 4-nitrofluorobenzene in DMSO with 19 secondary amines have also been determined. This reaction is the fastest with pyrrolidine, azacyclobutane and dimethylamine, and slowest with methylanisidine, diisobutylamine and diethanolamine (1639).

The dechlorination of 2- and 4-chloroquinolines, as well as 6- and 8-alkyl-substituted 4-chloroquinolines with piperidine in DMSO and other solvents has been studied (1240)(1239)(1238).

f) Nitro group displacement

In some cases, activated nitro groups can be displaced by amines. Thus, 2,5-dinitro-1-methylpyrrole undergoes nucleophilic aromatic substitution by piperidine (7756):

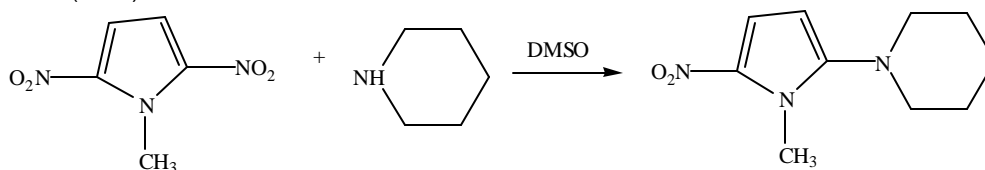

The reaction with the amine is favored by the accelerating effect of DMSO in aromatic substitutions by neutral nucleophiles.

g) Alkoxide and phenoxide displacement

The reaction of n-butylamine or t-butylamine with 2,4-dinitro-1-naphthyl ethyl ether gives the corresponding 2,4-dinitro-1-naphthylamines in high yields (3445):

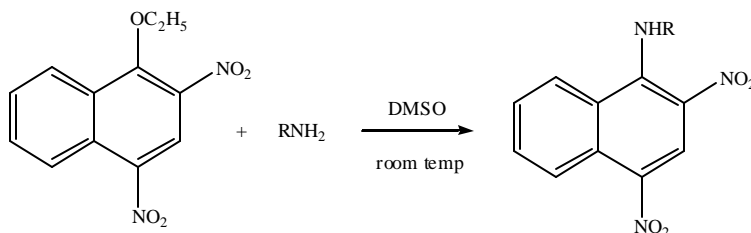

1-Piperidino-2,4-dinitronaphthalene can be prepared by reacting 1-methoxy-2,4-dinitronaphthalene with piperidine in DMSO. 1-Dimethylamino-2,4-dinitronaphthalene is prepared similarly (8408). The kinetics of the reaction of piperidine, n-butylamine, morpholine and benzylamine with 2,4-dinitrophenyl phenyl ether in DMSO has been studied as a function of amine concentration. The reactions of

the secondary amines are base catalyzed; those of the primary amines are not (9138).

5. Ammonia

DMSO is stable to ammonia. Displacement reactions with ammonia and amines are examples where the nucleophile is uncharged (3433). The solubility of ammonia is 40 liters per liter of DMSO at 1 atmosphere or 2.6% by weight (5033).

a) Aliphatic halide displacement

Reaction of methyl 2-bromo-3-phenyl-3-butenate with ammonia in DMSO gives the desired α -amino ester (10134):

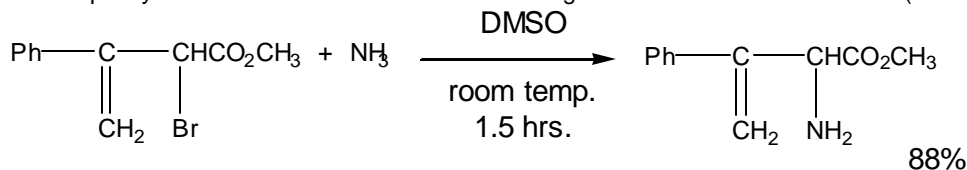

Secondary amine by-products are not found in any significant amounts in the above reaction. Somewhat similarly, isopropyl 2,3-dibromo-2,3-dihydrocinnamate reacts with ammonia to give isopropyl 2-phenyl 3-aziridine-carboxylate (10143):

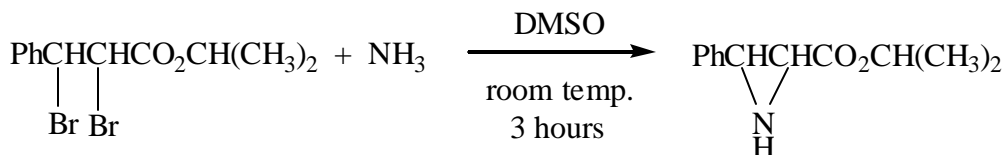

High yields of nitrilotriacetic acid are claimed when ammonia is reacted with chloroacetic acid in DMSO (4910):

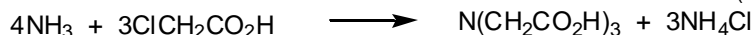

b) Aromatic halide displacement

2,4-Dinitrochlorobenzene reacts with ammonia to give 2,4-dinitroaniline (402):

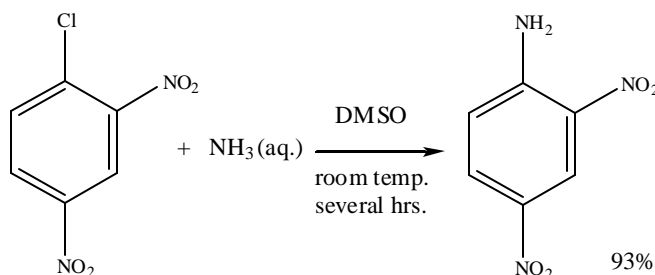

Similarly, p-aminotrifluoroacetophenone reacts with ammonia in DMSO (3399):

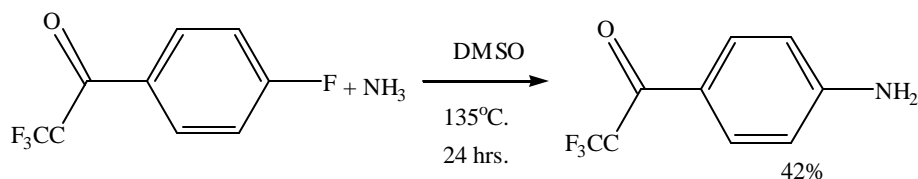

When DMF is used as the solvent in the above reaction, p-dimethylaminotrifluoroacetophenone results, apparently due to the hydrolysis of DMF to dimethylamine:

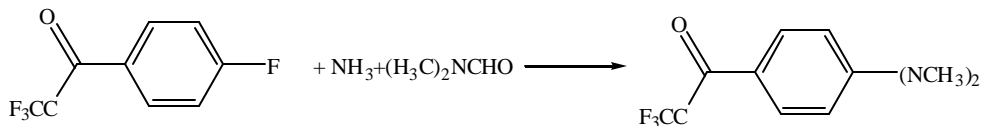

c) Alkoxide displacement

Displacement of an -OMe group by ammonia produces 3-amino-2-heteroarylpropenenitriles (10458):

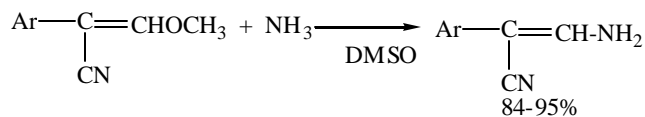

6. Azide Ion

Rate constants for displacement reactions by the azide ion in DMSO are up to about 10,000 times greater than for the same reaction in protic solvents, such as methanol (471). Reactions are frequently run with an excess solid sodium azide, making it a pseudo first-order

process. Under these conditions, the rate is also a function of the solubility of the reagent. Measurements of solubility show that sodium azide is much more soluble in DMSO than in some other solvents, and the solubility increases slightly with the addition of water (7527).

TABLE X
Solubility of Sodium Azide in Four Solvents

	Solubility, mol/l.			
	Dry	1% H ₂ O (110°)	5% H ₂ O (110°)	10% H ₂ O (110°)
2-Methoxyethanol	0.31 (124°)			
DMF	0.10-0.12	0.17	0.28	0.48 (25-150°)
DMSO	1.5-1.6	1.6	1.8	1.9 (95-150°)
HMPA	0.43	0.45	0.48	0.51 (110-150°)

a) Aliphatic halide displacement

Some aliphatic halides are easily displaced by the azide ion in DMSO (4815). Thus, the reaction of 2-(2-nitrophenyl)ethyl bromide with a 3-fold excess of sodium azide gives a 95% yield of 2-(2-nitrophenyl)ethyl azide (4360):

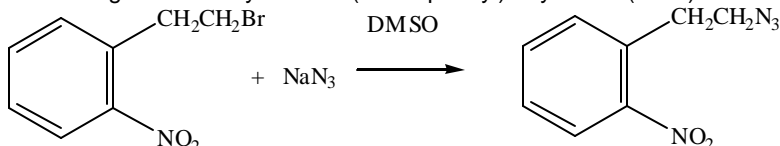

b) Aromatic halide displacement

Treatment of 4-fluoro- or 4-iodonitrobenzene with sodium azide in DMSO produces a quantitative yield of 4-nitrophenyl azide (471):

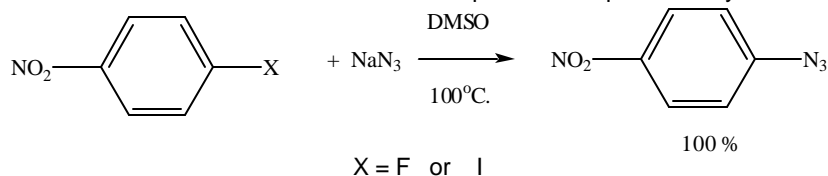

When 4-chloro-3-nitrobenzoic acid is treated with sodium azide in DMSO, the 5-carboxybenzofuroxan results (1007):

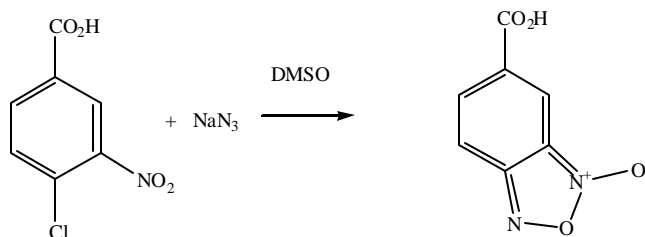

Reaction of 2-chloroquinoxaline 1-oxide with sodium azide in DMSO at room temperature gives 2-azidoquinoxaline (9767):

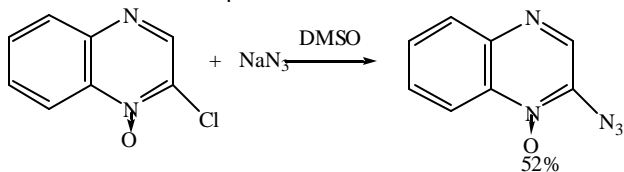

c) Nitro group displacement

The aromatic nitro group can also be displaced by dry sodium azide in DMSO (6572). Thus, 2,3-dinitroacetanilide with sodium azide gives the monoazido-derivative (4600):

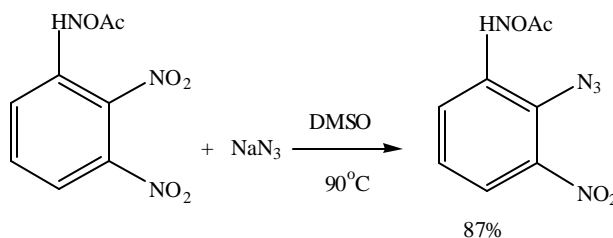

d) Sulfonate displacement

Sulfonates, such as toluenesulfonates and methanesulfonates are also readily displaced by the azide ion in DMSO (4920)(8339). A high yield of the 2,3-diazidobutane is obtained when meso-1,4-di-O-acetyl-2,3-di-O-(methylsulfonyl)erythrol is reacted with a slight excess of sodium azide (7692):

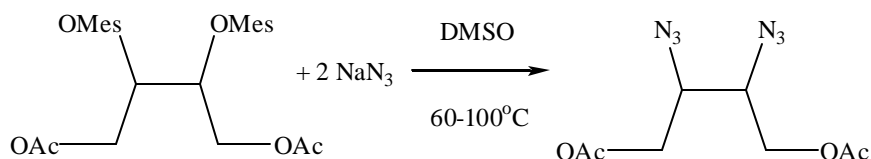

The above described displacements are frequently used to prepare amino sugar derivatives by reducing the azido to the corresponding amino group (5481)(7071).

e) Other displacements

Treatment of fumaronitrile with sodium azide in DMSO with subsequent acidification leads to 1,2,3-triazole-4-carbonitrile (4249):

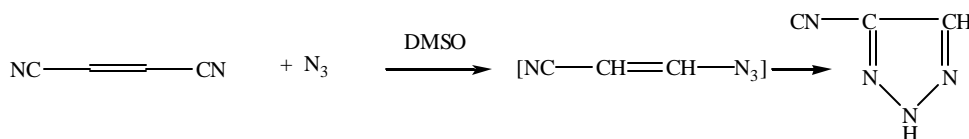

7. Carbanions

The majority of carbanions which are usually prepared as reaction intermediates or as transitory species in chemical reactions are readily obtained in DMSO.

a) Aliphatic halide displacement

The alkylations of 2,4-pentanedione with alkyl iodides and sodium hydride as the base may be more conveniently and rapidly achieved when DMSO is used in place of the usual alcohols or non-polar solvents (4261):

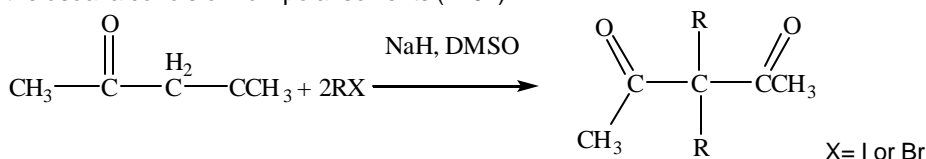

Similar results are obtained with malononitrile (599).

Alkylation of malonic esters in DMSO can be faster than in DMF, dimethoxyethane, THF and benzene. This alkylation is strongly accelerated by comparatively minor additions of DMSO to benzene. This could mean that DMSO disperses the ion aggregates (611)(612).

With ambident anions where either carbon or oxygen alkylation is possible, DMSO favors oxygen alkylation (690):

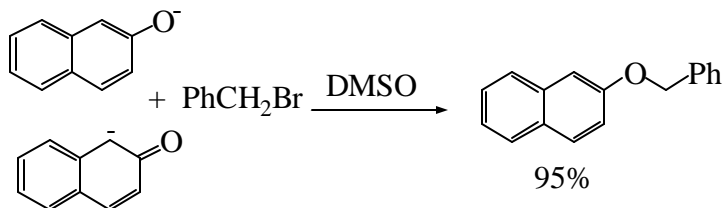

This is also demonstrated in the alkylation of β -ketoesters, where a proper choice of alkylating agent, temperature, and alkali metal can lead to significant amounts of O-alkylation (773)(1114)(1229).

Interaction of the potassium salt of 2-carboxy-cyclopentanone with an alkyl halide in DMSO at room temperature provides good yields of alkylated keto esters and probably constitutes the best method of alkylating this β -ketoester (1823):

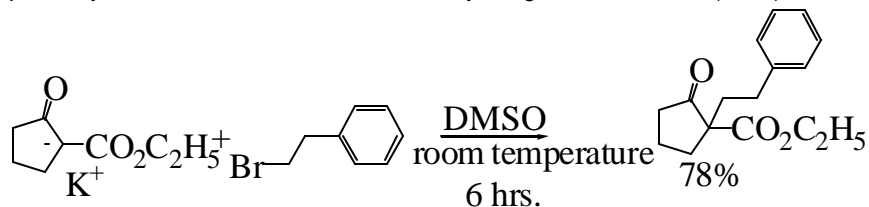

b) Aromatic halide displacement

Substituted o-nitrohalobenzenes reaction DMSO in the presence of powdered KOH with deoxybenzoin to form the corresponding nitroarylated deoxybenzoin (9439):

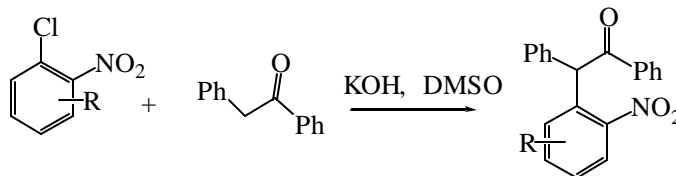

c) Nitro and sulfinate group displacement

It has been discovered that aliphatic nitro and sulfone groups can be displaced at tertiary carbon. Thus, the treatment of a,p-dinitrobenzene with the lithium salt of 2-nitropropane in DMSO gives the alkylation product (1237):

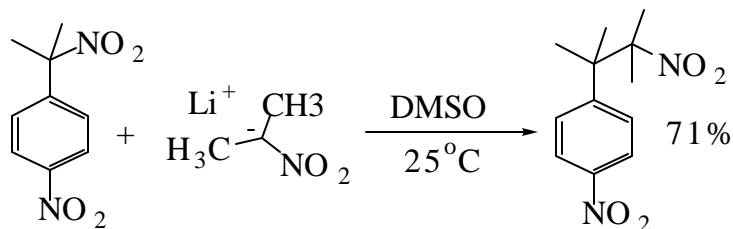

Nitrobenzenes substituted by an electron withdrawing group, such as p-dinitrobenzene, readily undergo displacement by the lithium salt of 2-nitropropane in DMSO (8436):

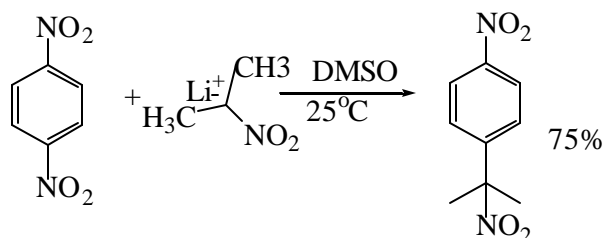

The sulfone group of a-nitrosulfones is also easily displaced by carbanions, e.g. the lithium salt of 2-nitropropane or the lithium salt of nitrocyclohexane (7108):

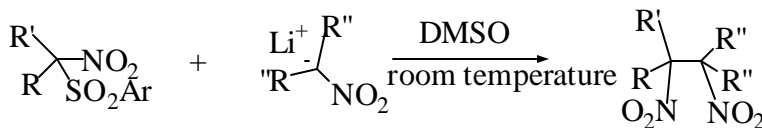

d) Other displacement reactions

Treatment of 2-cyanomethyl-2',4'-dimethoxybenzophenone with sodium methoxide in DMSO gives 9-cyano-2-methoxyanthracen-10-ol (3112):



When p-nitrobenzylidene diacetate is reacted with the lithium salt of 2-nitropropane in DMSO, a compound in which one of the acetate groups is replaced by the C(CH₃)₂NO₂ group is obtained (7657):

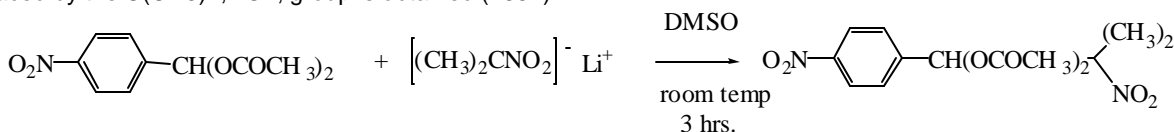

Treatment of (p-cyanobenzyl)trimethylammonium chloride with the lithium salt of 2-nitropropane gives the carbon alkylate (10399):

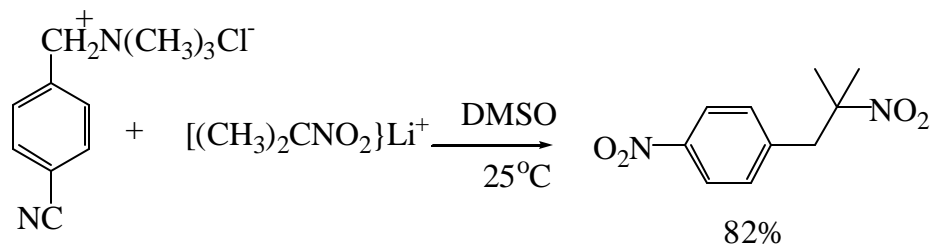

e) Use of aqueous sodium hydroxide as the base

It has been found that nitriles containing sufficiently activated methylene groups, such as phenylacetonitrile, can be conveniently alkylated in excellent yields and selectivities by using aqueous sodium hydroxide as the base and DMSO as the reaction solvent (3951):

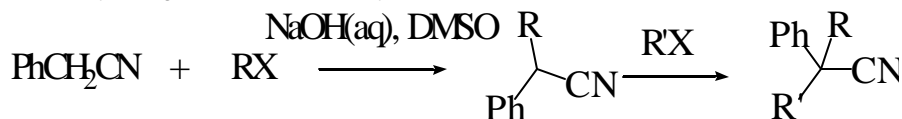

Previously, these reactions have usually been carried out by treating the nitrile with a strongly basic reagent, such as a metal amide, hydride, or alcoholate, followed by addition of the appropriate alkyl- or aryl hydride. These latter methods are generally cumbersome and

the selectivities are poor (3951).

Similarly, 50% aqueous sodium hydroxide in DMSO can be used as a base to induce an essentially quantitative cyclization of 5-chloro-2-pentanone to give cyclopropyl methyl ketone (3398):

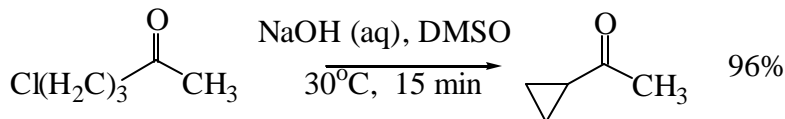

O- and C-alkylation of benzoin is also easily achieved by the reaction of alkyl halides in aqueous sodium hydroxide in DMSO at ambient temperatures (4699):

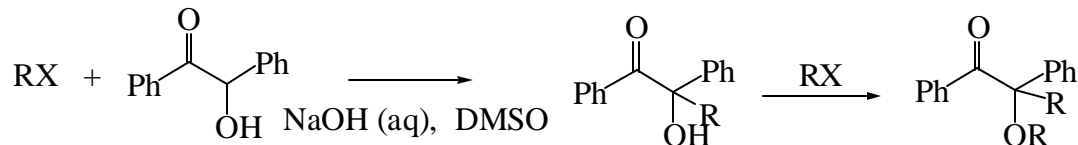

f) Use of calcium oxide as the base

In some cases, calcium oxide has been used as a base to produce carbanions. Diethyl malonate can be alkylated with benzyl bromide to yield diethyl benzylmalonate (3931):

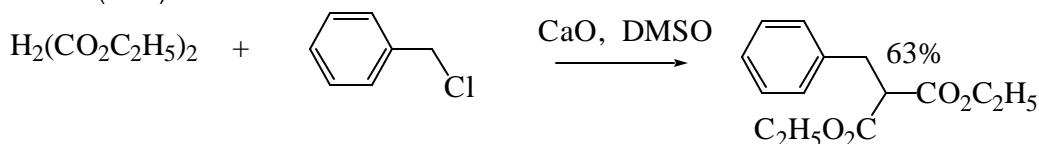

The use of lime in the dimethylation of 2,4-pentanedione gives a 73% yield of 3,3-dimethyl-2,4-pentanedione (3931).

8. Carboxylate Ion

Alkylation of carboxylate ions with alkyl halides in DMSO or DMSO-water is an efficient method of esterification (7950)(365)(8809). Carboxylate ions have also been used to displace sulfonates (8254). In aqueous DMSO systems, the reaction rate increases as the concentration of DMSO increases both for intramolecular and intermolecular displacement (407).

a) Aliphatic halide displacement

Simple alkyl halides, such as n-decylbromide, react with disodium phthalate in DMSO to give, e.g. didecylphthalate in 91% yield (2597). Carboxylic acid esters are prepared by reacting an organic halide and potassium or sodium acetate in DMSO (574)(6847).

Carboxylic acid esters are also prepared by reacting an acid with an organic halide in the presence of an alkali metal hydroxide in DMSO or DMSO-water, e.g. to obtain benzyl acetate (2969):

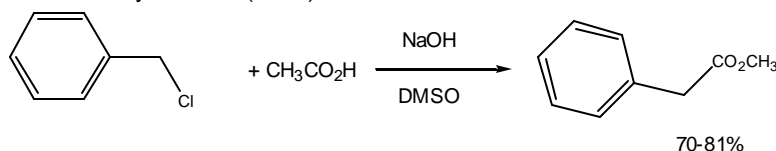

Potassium and sodium methacrylates react in DMSO with xylene dichlorides in DMSO to give unsaturated, polymerizable compounds (487):

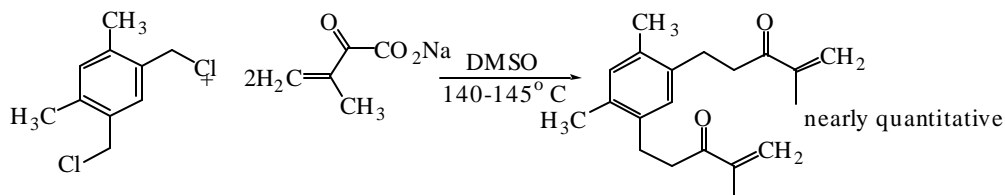

A convenient procedure for preparing pyruvic acid esters utilizes an organic halide as the starting material rather than the corresponding alcohol (9657). Thus, the reaction of sodium pyruvate with n-octyl iodide or phenacyl bromide in DMSO yields the esters:

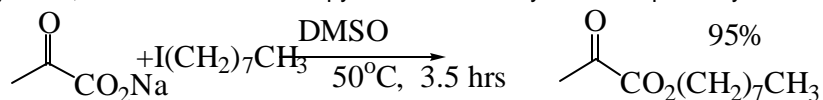

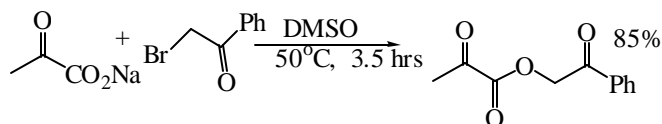

A ring opening and displacement reaction takes place when E and Z 2-phenylcyclopropyl bromides react with potassium acetate in DMSO in the presence of a crown ether (18-crown-6) (10465):

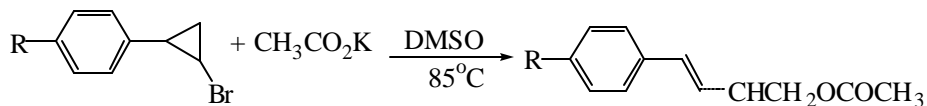

b) Sulfonate displacement

When the sodium or potassium 2-methanesulfonylbicyclo[3.3.1]nonane-1-carboxylate is heated in DMSO, the corresponding β -lactone is produced (6347):

9. Cyanate Ion

Sodium and potassium cyanates in DMSO can displace reactive halogens (26). When alkyl halides are reacted with cyanates, either isocyanates or isocyanurates result, depending on the reaction conditions and the solvent (440). DMSO plays a superior role in the displacement reaction and also in the subsequent trimerization of isocyanates. These reactions may be written as follows (386):

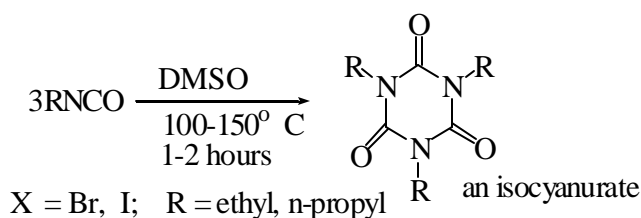
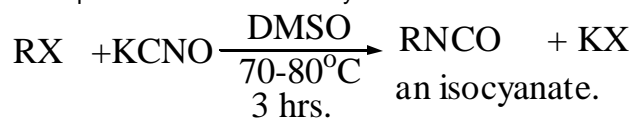

If an organic dihalogen compound is reacted with either potassium cyanate or sodium cyanate, the following reactions take place (9408):

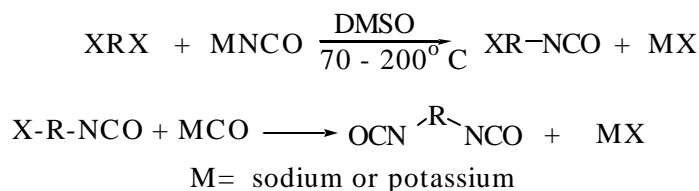

Under conditions causing trimerization, the products can be converted to the corresponding cyanurates:

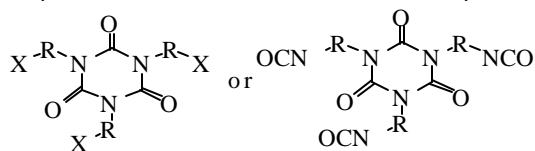

10. Cyanide Ion

Perhaps the most widely used of the displacement reactions in DMSO are those involving the cyanide ion. Halogen atoms and sulfonate (tosyl) groups are displaced rapidly by cyanide ion. Often the yields of the desired products are higher and side reactions are minimized in DMSO. Many products are more easily isolated from reaction mixtures containing DMSO.

Certain inorganic cyanides are more soluble in DMSO than in other organic solvents. Thus, DMSO can be used advantageously in systems where water is undesirable. At 95°C, about 10 g of sodium cyanide and/or 2 g of potassium cyanide will dissolve in 100 cc of DMSO. At 25°C, 1 g of either is soluble (964)(1924).

The solubility of sodium cyanide in DMSO at various temperatures is shown in Figure 7 below. The solubility of sodium chloride, the usual inorganic by-product when reacting sodium cyanide with organic chlorine compounds, is illustrated in the phase diagram, Figure 8.

Also soluble in DMSO are mercury cyanide, cadmium cyanide, and mixtures of potassium cyanide with copper, nickel, zinc, cobalt, or silver cyanides. These mixtures appear to be complex salts (801).

In many cases it is not necessary to have a complete solubility of sodium cyanide in DMSO. Reactions can be run using an agitated, stirred slurry of sodium cyanide with DMSO. Yields are commonly good with primary aliphatic halides, but somewhat lower with secondary ones due to dehydrohalogenation (475)(577)(8843).

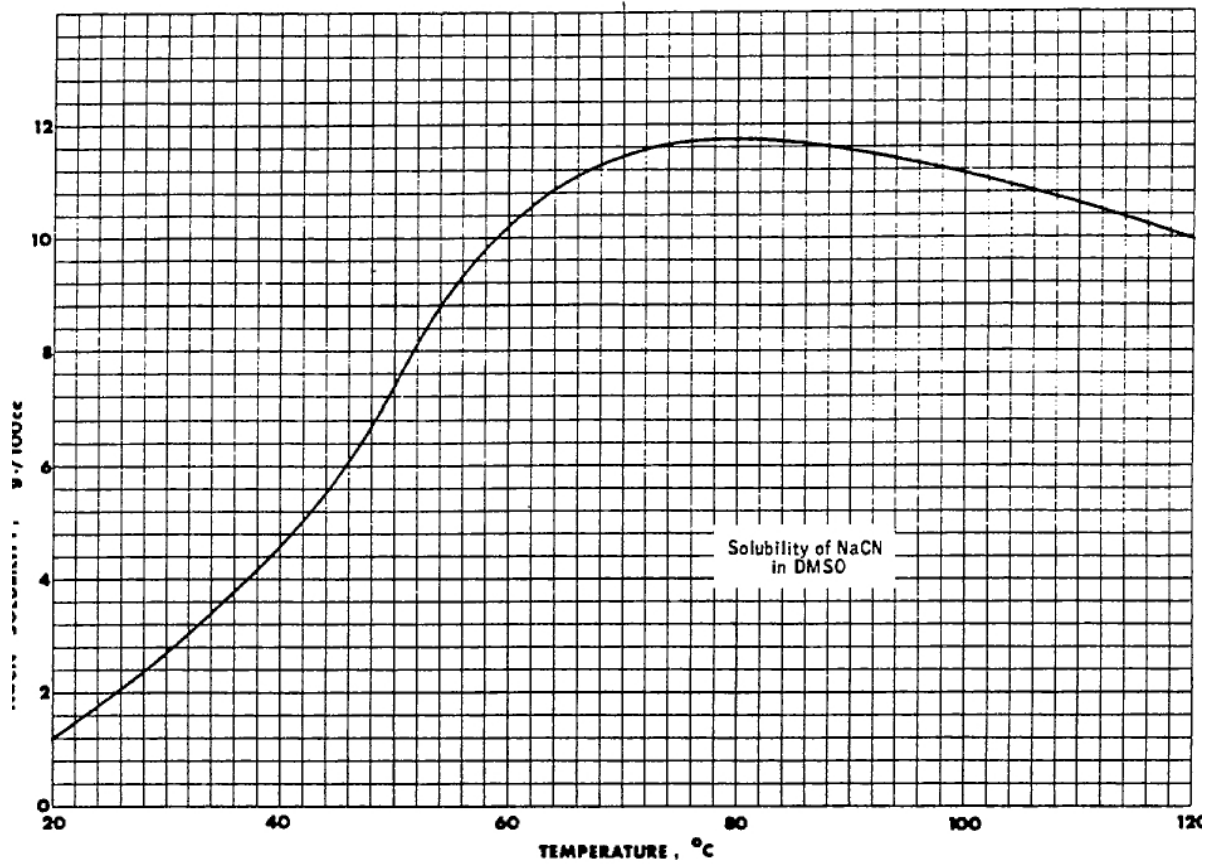

FIGURE 7

SOLUBILITY OF NaCl in
DMSO-H₂O MIXTURES
AT 25°C
(WT %)

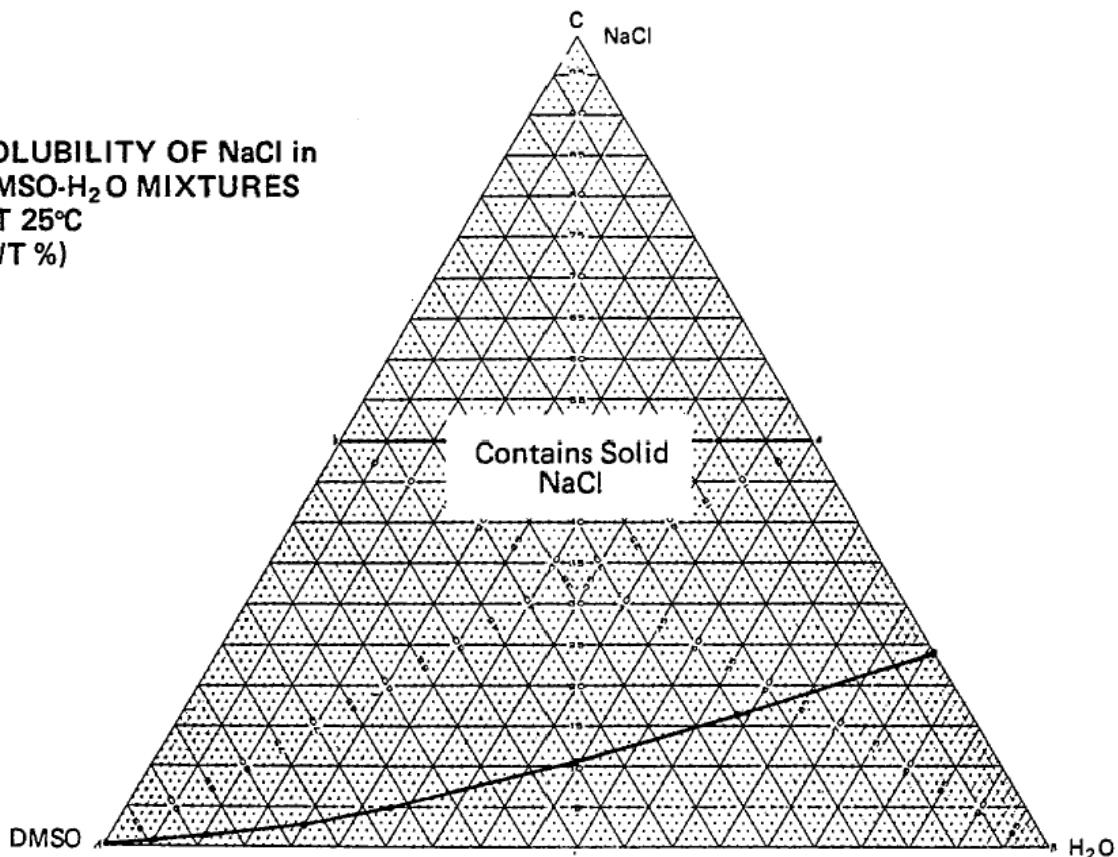
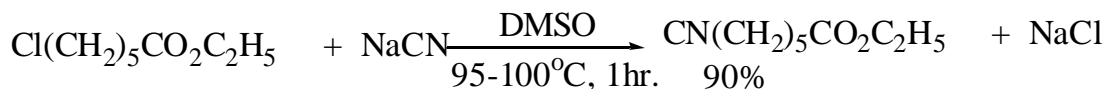

FIGURE 8

a) **Aliphatic halide displacement**

The reaction of sodium cyanide with ethyl 6-chlorohexanoate in DMSO gives a high yield of 6-cyanohexanoate (474):



Similarly, ethylene dichloride reacts with sodium cyanide to give acrylonitrile (473):

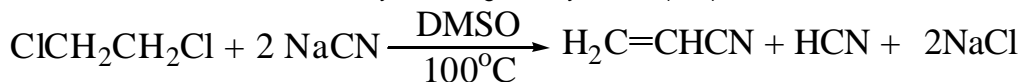

In the above case, both the displacement and elimination reactions take place.

The use of DMSO allows the cyanide ion to displace halides from neophyl and neopentyl compounds without rearrangement (475)(7547):

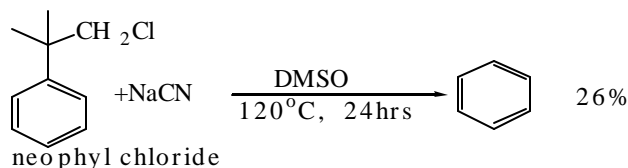

The displacement reactions of alkyl chlorides and bromides with potassium cyanide occur much more slowly when compared with sodium cyanide (475). This could be due to the lower solubility of potassium cyanide in DMSO. The yields are also lower and longer reaction times are required with DMF, sulfolane and dimethyl sulfolane as solvents (475). It has also been established that both primary and secondary alkyl chlorides react with sodium cyanide in DMSO to give high yields of the corresponding nitriles in shorter reaction times than have been obtained with bromides or iodides in aqueous alcohol solvent (577).

When 1-chloro-17-fluoro-8-heptadecyne is reacted with sodium cyanide in DMSO, 1-cyano-17-fluoro-8heptadecyne is produced in high yield (2189):

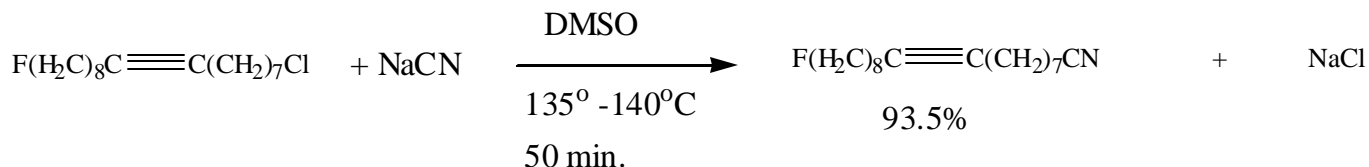

The difference in the reactivity of halogens is also illustrated in the reaction of 1,1-dichloro-2-(bromomethyl)-2methylbutane with potassium cyanide (2769):

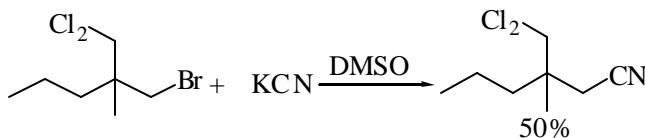

The use of sodium cyanide in the above reaction gives some undesirable by-products.

The enolate salt of ethyl 4-bromo-3-oxobutrate reacts with the cyanide ion in DMSO (9135):



?-Cyano N,N-disubstituted amides are conveniently prepared from halogenated amides by treatment with alkaline cyanides (9985):

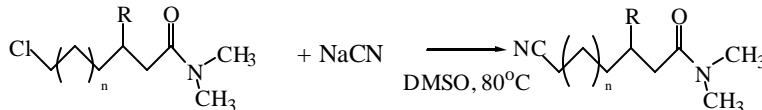

Poly[3,3-bis(chloromethyl)oxocyclobutane] reacts with sodium cyanide in DMSO to give the bis(cyanomethyl) derivative (6847):

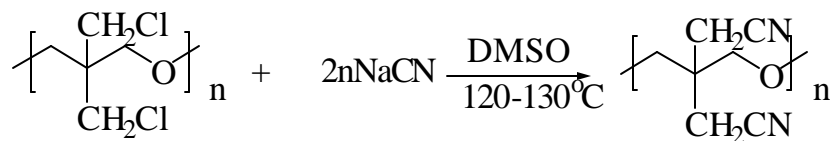

b) **Aromatic halide displacement**

Aromatic halides, particularly those not activated by electron withdrawing groups, are best displaced by using cuprous cyanide (1593)(1774)(1946). Thus, p-halophenol reacts with cuprous cyanide in DMSO to give p-hydroxybenzonitrile (1946):

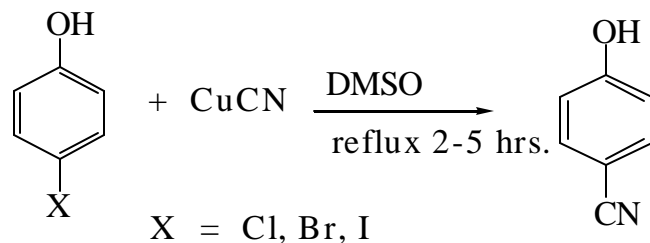

Cuprous cyanide and 9-bromoanthracene in DMSO give 9-cyanoanthracene in 91% yield (3247).

A procedure for the separation of isomers of dihalonitrobenzene consists of treating them with an alkali metal cyanide or cuprous cyanide in DMSO. When a mixture of 2,3- and 3,4-dichloronitrobenzene is thus treated, only the 2,3-isomer reacts, whereas the 3,4-isomer is recovered unchanged (1455):

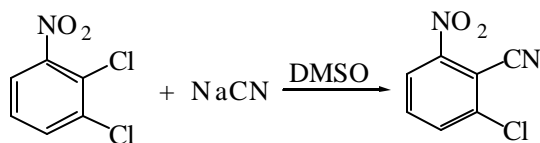

Sodium cyanide and o-fluoronitrobenzene in DMSO form 2-hydroxy-isophthalonitrile (8065):

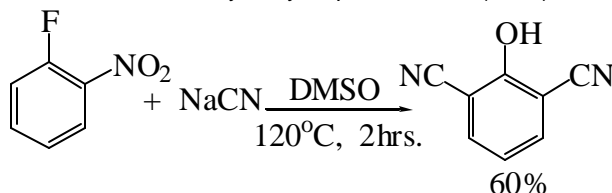

c) Hydrogen displacement

When o-nitrobenzonitrile is heated with sodium cyanide in DMSO hydroxy-isophthalonitrile is produced (8065).

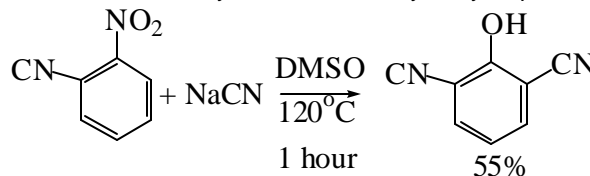

d) Quarternary ammonium salt displacement

When 2-pyrrolylmethylammonium salts are reacted with sodium cyanide both pyrrole-2-acetonitrile and "abnormal" nitrile are produced (8759):

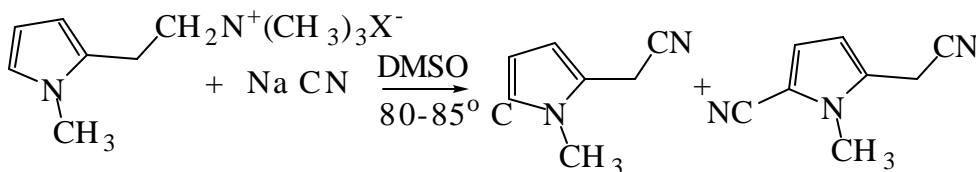

e) Sulfonate displacement

1-Chloro-4-(methylsulfonyl)benzene (I) and cuprous cyanide fail to react to give the desired 1-cyano-4-(methylsulfonyl)benzene when refluxed for 24 hours in DMF. However, when equimolar amounts of I and potassium cyanide are allowed to react in DMSO for 30 minutes, a 1:1 mixture of 1,4-bis(methylsulfonyl)benzene (II) and terephthalonitrile (III) is obtained in about 80% yield (1711):

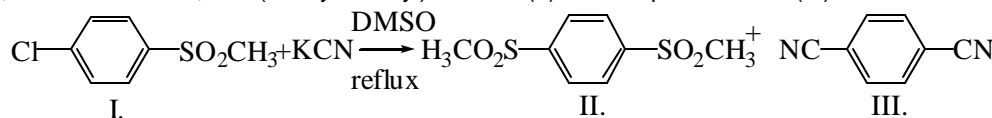

When 4-(methylsulfonyl)cinnoline and potassium cyanide are reacted in DMSO, 4-cinnolinecarbonitrile is produced quantitatively (1721):

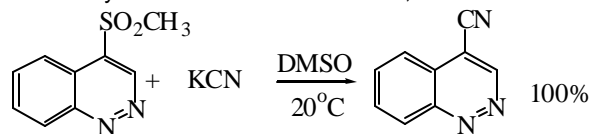

f) Sulfonate displacement

Sulfonates (e.g. tosylates) or disulfonates are converted in high yields to the corresponding nitriles or dinitriles with cyanides in DMSO (477)(2525)(10044). Thus, azulene-1,3-bis(hexanenitrile) and azulene-1,3-bis-(pentanenitrile) are prepared by treating the corresponding tosylates (or chlorides) with sodium cyanide (2783).

A neopentyl substitution product can be obtained by treating the corresponding tosylate with potassium cyanide in DMSO (8255):

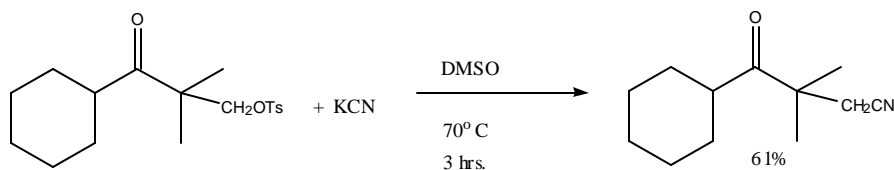

g) Other displacement reactions

Reacting a chloromethyl-1,2,3,4-tetrahydropyrimidine-2-one or 4-(1-chlorethyl)- 4-dihydropyridine with sodium cyanide gives the ring-expansion products (4739)(9986). Thus, the above-mentioned pyrimidine produces a 7 membered ring compound (4739):

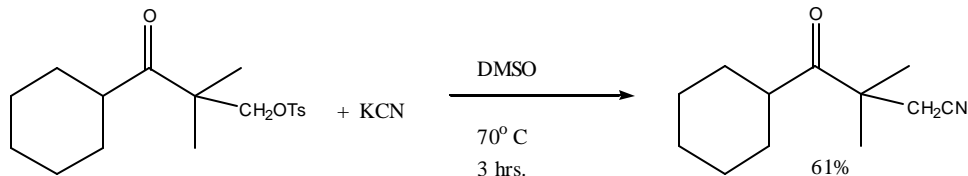

Displacement of primary or secondary hydroxyl groups by nitrile groups is accomplished by a short refluxing of the alcohol and triphenylphosphine in carbon tetrachloride, followed by the addition of DMSO and sodium cyanide to obtain 70-85% yields of the corresponding nitriles (872).

11. Halogen Ion

Displacement of halogen or other groups by halide ions is frequently easy in DMSO. Exchange reactions between halogens often require high temperatures and because of its boiling point of 189° C, DMSO is the solvent of choice.

a) Aliphatic halide displacement

The kinetics of homogeneous isotope exchange between ^{36}Cl in cyclic compounds (e.g. cyclopentyl chloride, cyclohexyl chloride, cycloheptyl chloride, cyclooctyl chloride) and lithium chloride has been studied in DMSO. This exchange is a bimolecular $\text{S}_{\text{N}}2$ reaction (109)(651):

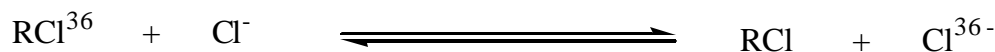

Similar exchange reactions between n-hexyl chlorides (containing ^{36}Cl) and n-hexyl bromides (containing "Br") and lithium chloride and bromide have also been studied in DMSO (650).

By exchanging two bromine atoms in the 1,4-positions with lithium chloride in DMSO, 1,4-di-p-tolyl-1,4-dichloro-2,3-dibromo-2-butene can be obtained (2760):

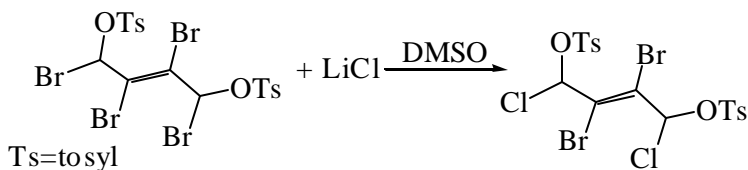

Nucleophilic reactions between halogeno(phenyl)acetylenes and halide ions have also been examined in DMSO (10394), eg.

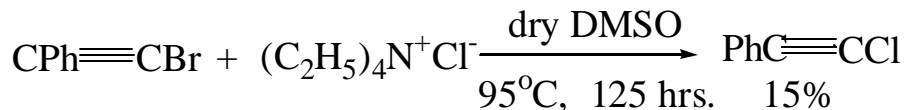

b) Aromatic halide displacement

The chloride ion in chloro nitrobenzenes can be replaced by fluoride with potassium fluoride in DMSO (438):

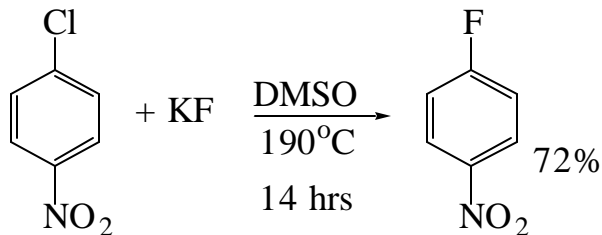

Quantitative studies are reported for substitution of the type $\text{ArHal} + \text{CuX} \rightarrow \text{ArX} + \text{CuHal}$ in DMSO and other polar solvents (541)(1593)(1214). Ease of replacement follows the order: $\text{H} > \text{I} > \text{Br}, \text{Cl}, \text{F}$; $\text{X} = \text{Cl}, \text{Br}, \text{I}$. The reaction rates are the highest in DMSO among the solvents examined. Thus [1- ^{36}Cl]chloronaphthalene can be prepared from 1-bromonaphthalene and radioactive cuprous chloride (1593):

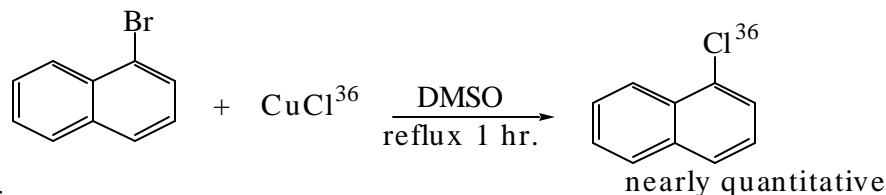

c) Sulfonate displacement

Sulfonates (e.g. tosylates, nosylates = $p\text{-O}_2\text{N-Ph-SO}_3$) can be displaced by halogens by reacting them with lithium chloride, lithium iodide (4066)(5836), lithium bromide (4066) or sodium bromide (1027) in DMSO. Pure secondary alcohols can be converted to bromides without rearrangement by first preparing the tosylates and then reacting them with sodium bromide in DMSO at room temperature (1027).

Treatment of endo-5,6-bis(p -toluenesulfonyloxy-methyl)-2-norbornene with cesium chloride in DMSO gives the endo-5,6-bis(chloromethyl)-2-norbornene (10002):

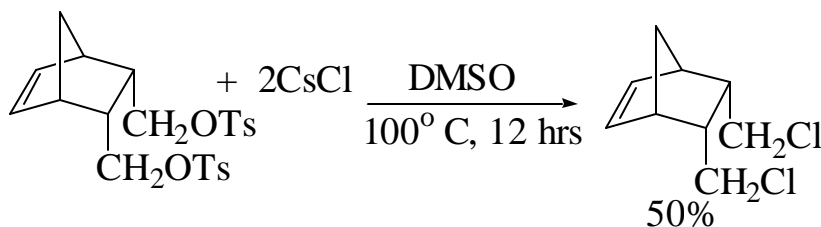

d) Displacement of diazonium ion

p -Nitrobenzenediazonium tetrafluoroborate in DMSO reacts with iodides, bromides and chlorides to give the corresponding p -halonitrobenzene (99), e.g.:

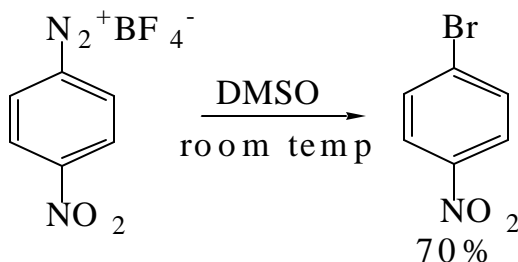

12. Hydroxide ion

The basicity of hydroxides in DMSO closely parallels that obtainable with alkoxides, as shown in Figure 10 in which acidity functions up to 26 are obtained with 0.01 tetramethylammonium hydroxide in DMSO (1172). The solubility of the hydroxides is generally low, ranging from 7×10^3 mol/liter for sodium hydroxide (725) to 0.12 for tetramethylammonium hydroxide at room temperature (1172) (see Table IX). Additions of water increase the solubility of alkali metal hydroxides, but the increased solubility is accompanied by a decrease in the activity of the dissolved hydroxide ion. Figure 9 is a phase diagram of the water-DMSO-metal hydroxide systems for NaOH and KOH. Potassium hydroxide is consistently more soluble than sodium hydroxide at a given water content. In spite of the low solubility of alkali metal hydroxides in DMSO, satisfactory use of the strong basicity of the hydroxide ion is sometimes achieved by using a slurry of the powdered base in the reaction.

a) Aliphatic halide displacement

When the alkaline hydrolysis of methyl iodide is studied in the presence of hydroxyl ion in DMSO-water, the rate of hydrolysis increases with increasing DMSO content (329):

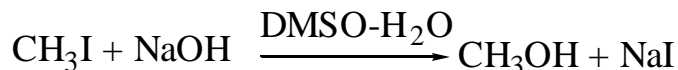

Similar results are obtained with other primary alkyl halides (iodides, bromides, chlorides)(913).

The rate constants for the reaction of hydroxide ion with ring substituted benzyl chlorides in acetone-water and DMSO-water mixtures are reported as a function of both solvent composition and temperature. The reaction rate increases with increasing DMSO concentration but decreases with increasing acetone concentration (432).

b) Aromatic halide displacement

The reaction of 2,4-dinitrofluorobenzene and 4-nitrofluorobenzene with hydroxide ion in DMSO-water are strongly accelerated by DMSO (328).

Hydrolysis of o- and p-nitrochlorobenzenes with caustic soda in DMSO produces o- and p-nitrophenols (3925):

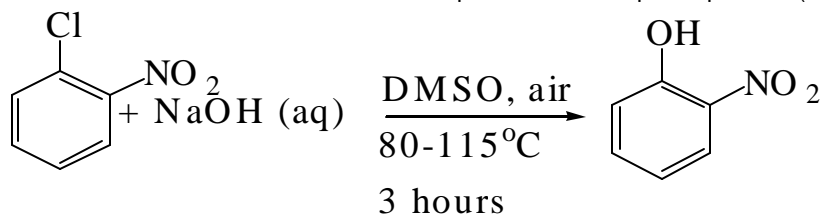

Nucleophilic substitution reactions have also been carried out on a variety of mono- and dihalogen-1,2,3-benzothiadiazoles, e.g. 6-chloro-4-fluoro-1,2,3-benzothiadiazole, with potassium hydroxide in aqueous DMSO to give the corresponding phenol (4425):

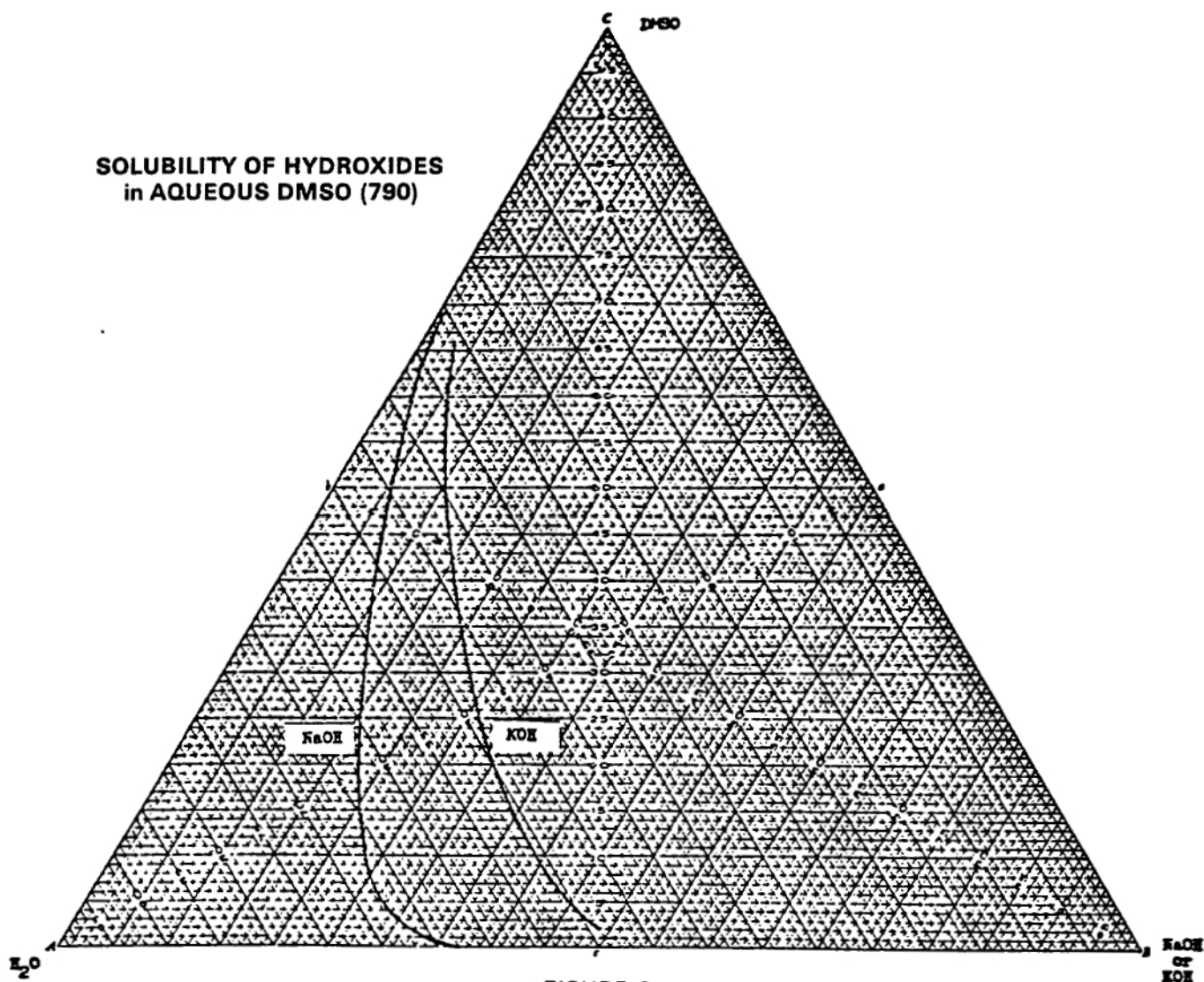
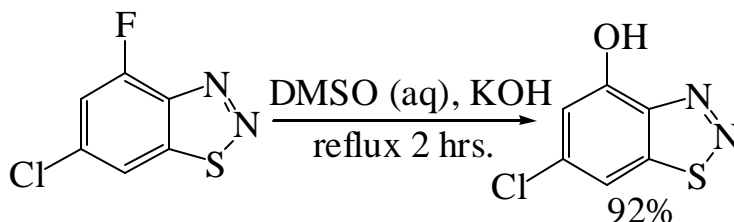

c) Nitro group displacement

The nitro group in 4-nitropyridine N-oxide, p-nitrobenzophenone and 1-nitroxanthone can be replaced with aqueous sodium hydroxide to give the corresponding phenols or 1-hydroxyxanthone, resp. (409)(470).

When p-dinitrobenzene is reacted with hydroxide ion in aqueous DMSO, one nitro group is displaced (6937).

13. Mercaptide (or Thiophenoxide) Ion

The mercaptide or thiophenoxide ions are known as good nucleophiles, and significant rate increases have been observed in DMSO when compared to the same reaction in alcohols (399).

a) Aliphatic halide displacement

A number of alkyl halide displacements with mercaptides or thiophenoxides have been studied in DMSO (680) (712)(8779). Thus, the reaction of a, a' - dibromo- a, a', a'-tetrafluoro-p-xylene with sodium ethyl mercaptide gives the corresponding a, a'-bis(ethylthio)xylene (3386):

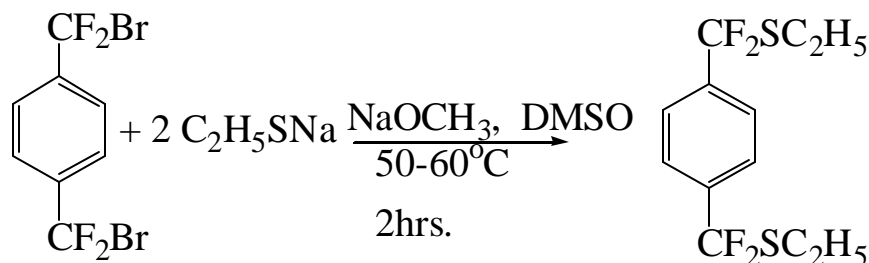

Methyl perfluoroalkyl sulfides may be prepared by reaction of the perfluoroalkyl iodides with sodium methyl mercaptide and dimethyl disulfide in DMSO (4792), e.g.:

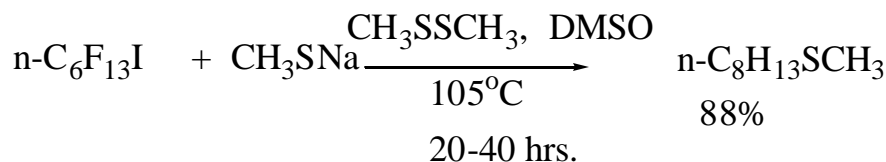

A derivative of poly-3,3-bis(chloromethyl)oxacyclobutane is prepared by reacting it with sodium benzyl mercaptide in DMSO (6847):

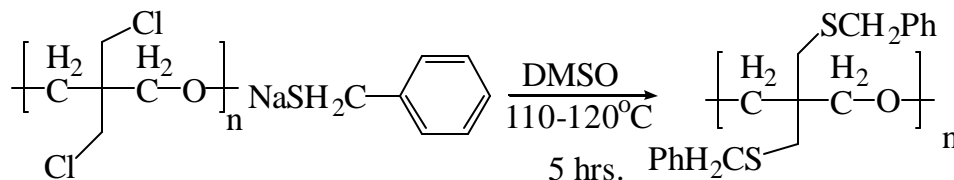

b) Aromatic halide displacement

Aromatic halogens are replaced by mercaptide or thiophenoxide ions in DMSO (541), particularly when the aromatic ring contains electron withdrawing groups in the ortho- or para-positions to the halogen (8344)(399). Thus, potassium benzyl mercaptide reacts with p-fluoronitrobenzene in DMSO-methanol under mild conditions (399):

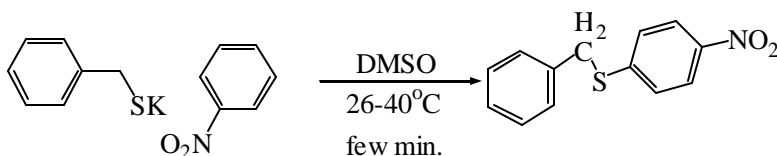

The reaction rate of the above reaction increases significantly with increasing DMSO concentration.

The reactions of 4-methylthiophenoxide with 3- or 4-halo-substituted phthalimide derivatives have been studied in DMSO (9771):

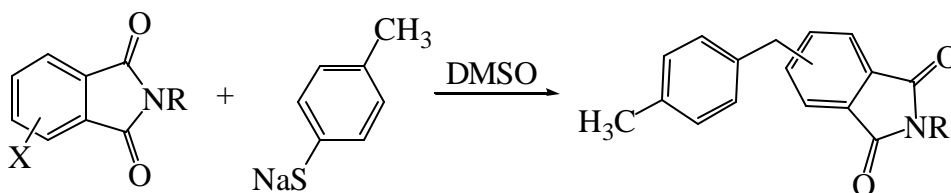

Nucleophilic substitution reactions have been carried out with mercaptide or thiophenoxide ions on a variety of mono- and dihalogen-1,2,3-benzothiadiazoles (4425).

c) Nitro group displacement

The nitro group at certain tertiary carbon atoms can be displaced by thiophenoxide in DMSO-methanol (1237) or

methyl mercaptide ions in DMSO (10008). The yields of the tertiary sulfides are very high in both cases, e.g. (10008):

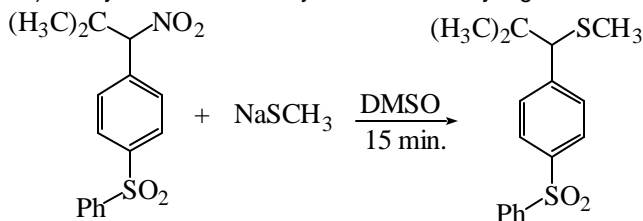

The nitro group in substituted nitrobenzenes is displaced by the thiophenoxide ion (9771) or mercaptide ion (4068) (9771) to give the diaryl or alkyl aryl sulfides, respectively, e.g. (4068):

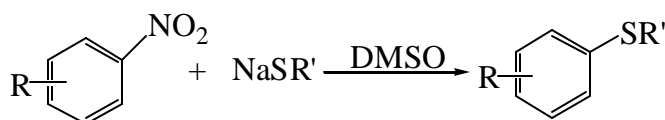

d) Sulfonate group displacement

The reactions of the tosylate of 2,2,2-trifluoroethanol with the sodium salts of methyl, ethyl or 2-hydroxyethyl mercaptides in DMSO give the expected thio ethers (589):

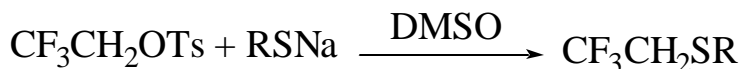

14. Nitrite Ion

Sodium nitrite has good solubility in DMSO. Thus, in a few minutes, 100 cc of DMSO dissolves 19.2 g of sodium nitrite, whereas only 1.88 g dissolves in 100 cc of DMF at room temperature after 24 hours. In DMSO it is not necessary to add urea to increase the solubility of sodium nitrite, as is the case with DMF (685). Displacement reactions involving the nitrite ion have been studied rather extensively in DMSO.

a) Aliphatic halide displacement

The displacement of aliphatic iodide, bromide or chloride to give the corresponding nitro compound is readily accomplished in DMSO with yields ranging from 50-91 %, depending on the structures involved (684)(3686) (4562). Primary and secondary alkyl bromides and iodides react with sodium nitrite to produce the corresponding nitro compounds (486), e.g. 1-bromooctane gives 1-nitrooctane (685):

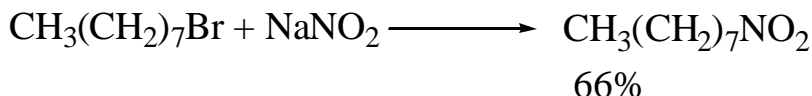

Lower nitroparaffins are prepared by treating the corresponding C1-3 alkyl chlorides with alkali metal nitrites in DMSO (10286):

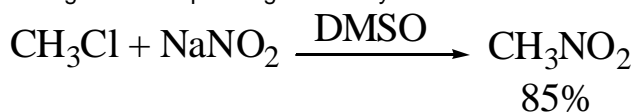

When α -haloesters are reacted with sodium nitrite in DMSO, the nitro ester initially formed is quickly converted to the α -nitrite ester (684):

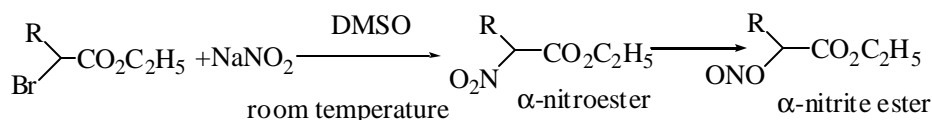

However, by adding phloroglucinol to the reaction mixture, the formation of nitrite ester is prevented and pure α -nitroesters are produced in excellent yields (682)(684)(691).

When 1,3-dihalogen compounds, such as 3-bromo-1-chloropropane, are reacted with sodium nitrite, a heterocyclic compound is obtained, e.g. 3-nitro-2-isoxazole (366)(988):

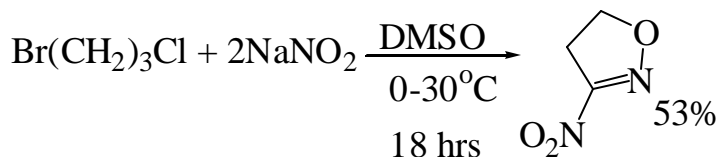

Other substitutions at tertiary carbon atoms involving the nitrite ion have been studied (2565)(2566)(3490). The reaction of 1-iodo-4-heptyne with sodium nitrite in DMSO produces 1-nitro-4-heptyne (4384)(6692):

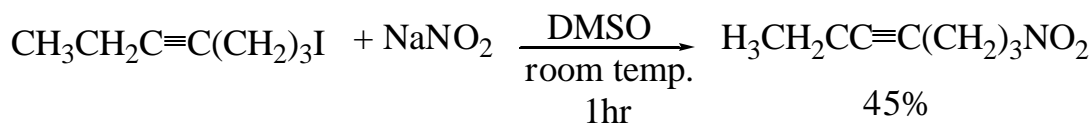

b) Aromatic halide displacement

Aromatic halides can also be displaced by the nitrite ion (8063). When 2,4-dinitrochlorobenzene is reacted with sodium nitrite in DMSO, 2,4-dinitrophenol is formed (402)(4562):

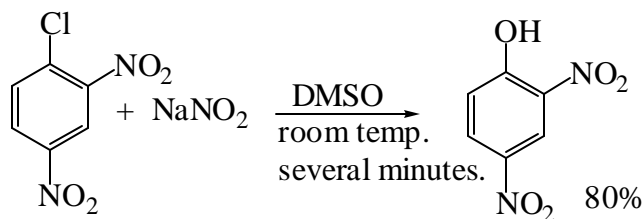

c) Sulfonate displacement

The reaction of the tosylate of the secondary alcohol (in the steroid or prostaglandin series) with potassium nitrite in DMSO affords the inverted alcohol as the main product together with the corresponding nitroalkane, ketone, and alkene (10454):

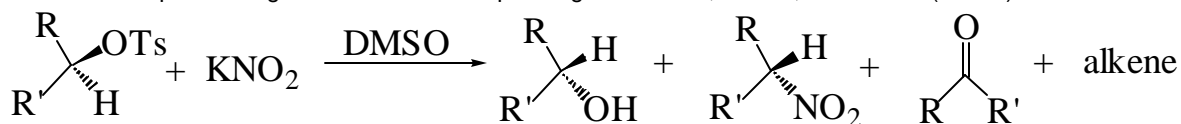

15. Phenoxide Ion

DMSO enhances the rate at which halides are displaced by phenoxides (phenol, catechol, hydroquinone) almost as much as it does for alkoxides or mercaptides (399). With ions such as naphthoxide, where a choice exists between carbon and oxygen alkylation, the reaction in DMSO gives almost exclusively oxygen alkylation (690). DMSO is a good solvent for phenoxide ions. Thus, the polymerizations of the dipotassium salt of bisphenol A with dihaloaromatic compounds proceeds best in DMSO when compared to other dipolar aprotic solvents (6026). The alkylation of phenoxide is enhanced more than the alkylation of amino groups in DMSO. The phenoxide group in tyrosine can be selectively etherified without blocking the amino group (442). DMSO is also a good solvent in the nucleophilic displacement of activated aromatic nitro groups by phenoxides for the synthesis of aromatic ethers (10434).

a) Aliphatic halide displacement

DMSO can be used as the solvent in alkylation of sterically hindered phenols (884)(3631)(3830)(4573). When 2,6-di-tert-butyl-4-methylphenoxide is reacted with ethyl iodide, the major product is the corresponding ether (517):

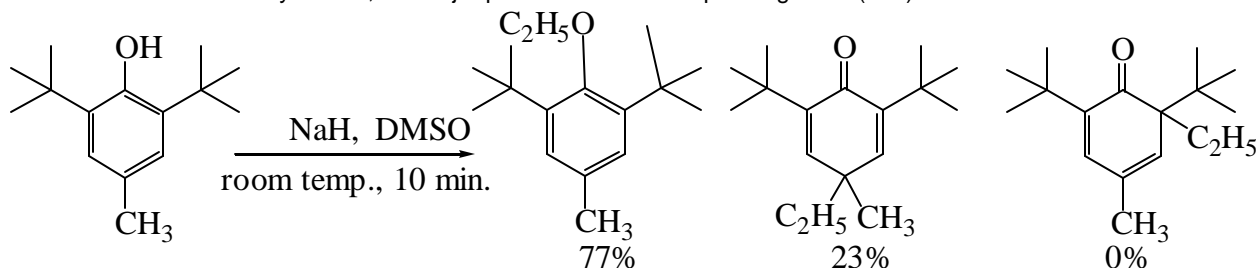

With tert-butyl alcohol as the solvent, the corresponding product distribution is 19%, 73%, 8%, and the reaction takes several days instead of 10 minutes, as in DMSO.

When 2-tert-butyl-5-methylphenol is alkylated with allyl bromide in DMSO with sodium methoxide as a base, a 97% yield of allyl-tert-butyl-5-methylphenyl ether is obtained (885).

Reaction of polychloroethanes with sodium phenoxide in DMSO gives phenoxychloroethylenes (8410):

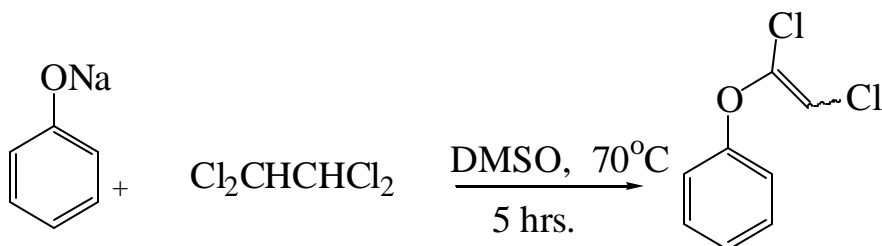

Sodium methyl salicylate and diiodomethane in DMSO give formaldehyde disalicyl acetal (6460):

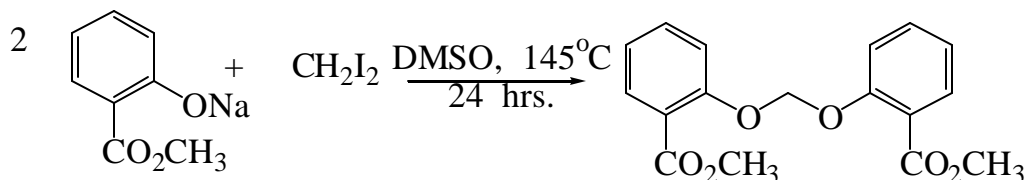

Alkylation reactions of the bifunctional β -bromo-1,2-epoxyalkanes have been found to be markedly dependent upon the solvent. In alcoholic media, phenoxides react by opening the epoxide ring to give β -hydroxy- γ -bromoalkyl derivatives. In DMSO, these same compounds react by displacement of bromide ion to give epoxyalkyl derivatives (3395). Polyhydroxyethers can be synthesized from mono-alkali metal salts of bisphenols, such as 4,4'-sulfonyldiphenol, and 1-halo-2,3-epoxyalkanes in a one-step reaction in DMSO (10437):

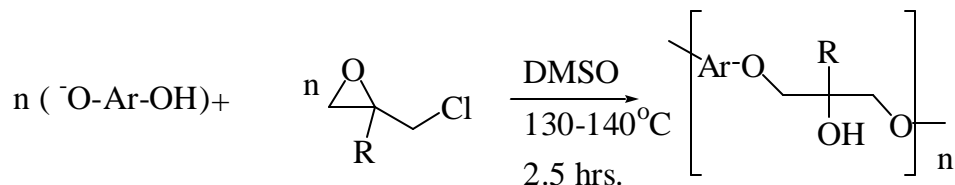

A number of catechol ethers have been prepared by using DMSO as the solvent (9145). Catechol reacts with methylene chloride in DMSO with sodium hydroxide as the base to give 1,2-methylenedioxybenzene (2887):

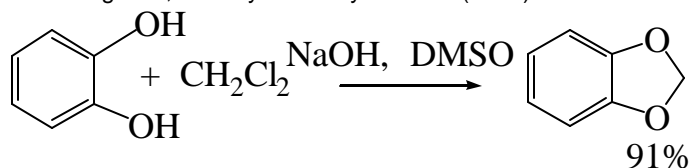

b) Aromatic halide displacement

The phenoxide ions in DMSO have been used in many aromatic halide displacement reactions (399)(690). Activated fluorobenzenes react with alkali metal salts of divalent phenols to give aryloxy compositions (8683):

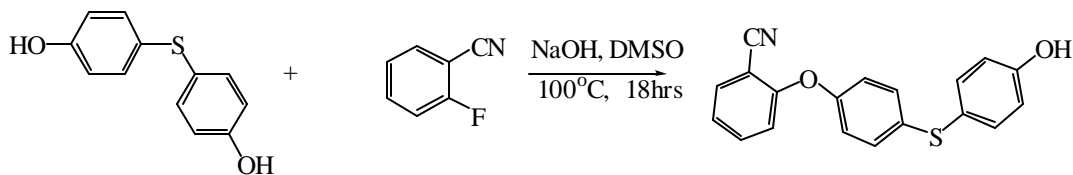

Phenoxides also react with halo-substituted phthalimide derivatives in DMSO to produce high yields of ether imides (9096):

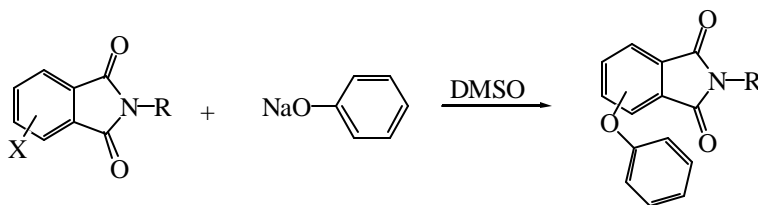

The dipotassium salt of 3-hydroxybenzoic acid reacts with 3,4-dichlorobenzotrifluoride in DMSO to yield 3-(2-chloro-4-trifluoromethylphenoxy)-benzoic acid (10320):

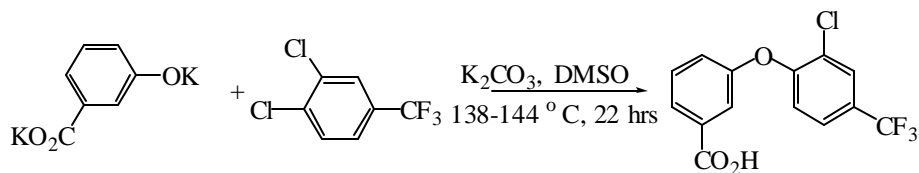

The ability of phenoxide ions in DMSO to displace aromatic halogens and the solubility of the phenoxide ions in DMSO are used in polycondensation reactions to obtain linear, high molecular weight aromatic polyethers (6026)(6830)(7699). Thus, bisphenol A can be polymerized with 4,4'-dichlorodiphenyl sulfone in DMSO to prepare a polyether sulfone (6831):

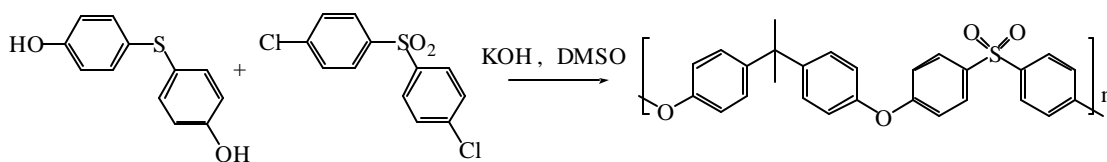

The dipotassium or disodium salt of catechol in DMSO reacts smoothly with some polyhalogenated benzenes (or heterocycles) to give good yields of the corresponding dibenzo-p-dioxins (7553)(8311), e.g. (7047):

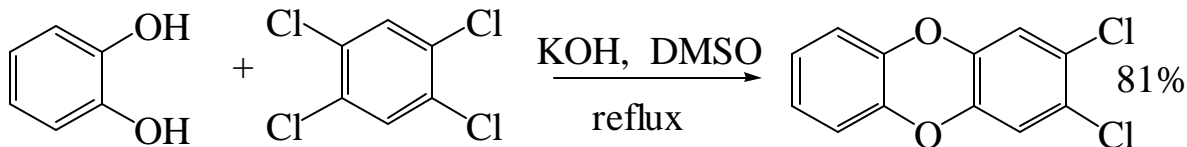

c) Nitro group displacement

Some activated nitro groups are displaced with ease by phenoxide ions (8984)(8350)(8685):

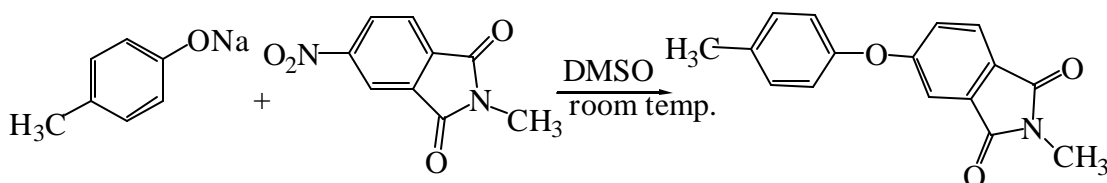

Nucleophilic displacement of activated aromatic nitro groups with aryloxy anions in DMSO is a versatile and useful reaction for the synthesis of aromatic ethers (10434). This reaction has also found applications in polymers, particularly in the preparation of polyimides (7710)(8287).

d) Phenoxide displacement

Polyetherimides can be made by effecting an interchange reaction, in the presence of an alkali phenoxide, between aryloxy-substituted bisphthalimide and disodium salt of, e.g., bisphenol A in DMSO (8714):

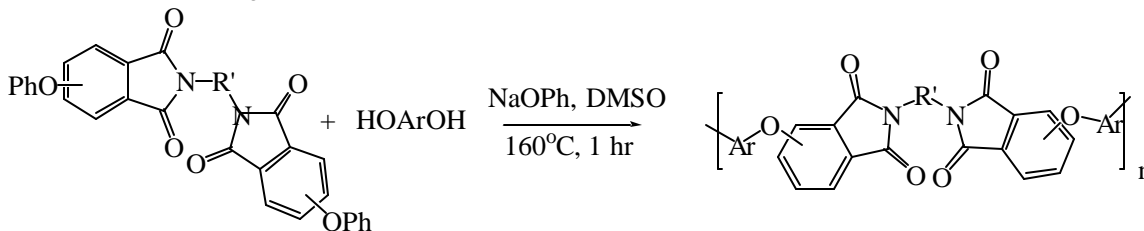

e) Sulfonate displacement

The monotosylate of 2-t-butyl-1,3-propane can be transformed to phenoxyalcohol with sodium phenoxide in DMSO (6315):

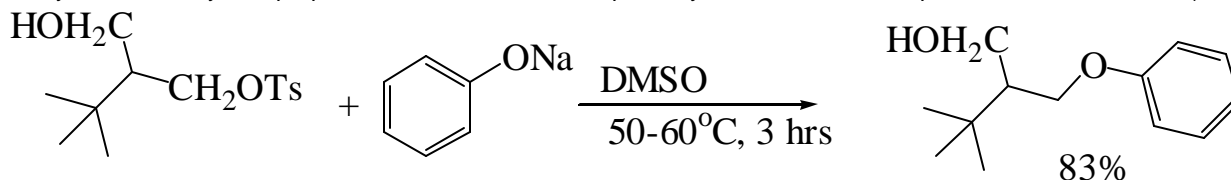

16. Sulfide (or Hydrosulfide) and Thiosulfate Ions

The sulfide and hydrosulfide ions act as nucleophiles and both these ions can be alkylated and/or arylated in DMSO. Water seems to be a necessary component for thiosulfate solubility. The rate constant for the reaction of thiosulfate in aqueous DMSO is at least an order of magnitude larger than in other solvents (656).

a) Aliphatic halide displacement

Polymercaptans can be produced by reacting polyhalo compounds with sodium sulfhydryte (sodium hydrogen sulfide) in DMSO, e.g., 1,2,3-trichloropropane and sodium sulfhydryte give the corresponding trimercaptan (6192):

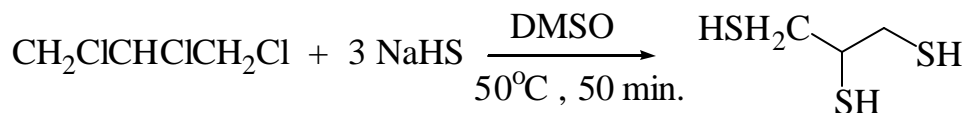

A mixture of either an aryl isothiocyanate or an aryl isocyanide dichloride, methylene bromide, and a sulfide source, such as ammonium sulfide or sodium sulfide, can be reacted in DMSO to provide a one-step synthesis of aromatic 2-imino-1,3-dithietanes (7528):

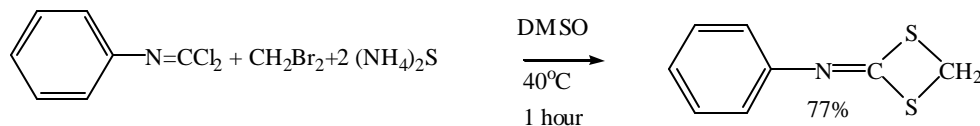

The β -activated diethyl sulfides can be prepared by reacting the appropriate chloride with sodium sulfide in DMSO (6398):

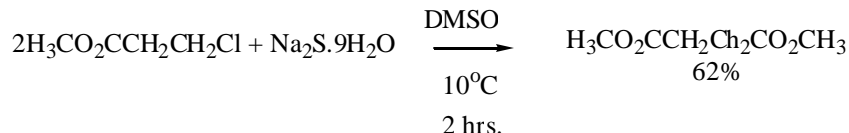

Sodium thiosulfate and benzyl chloride react to yield sodium benzylthiosulfate which forms dibenzyl disulfide (472):

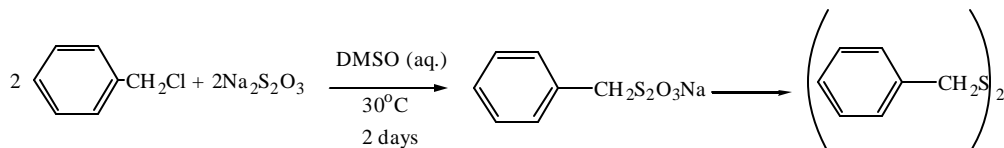

b) Aromatic halide displacement

Sodium sulfhydryte can also displace aromatic halogens from activated nuclei, as in the reaction with chloro-4-nitro-3-trifluorotoluene in DMSO. The major product is a disulfide (4123):

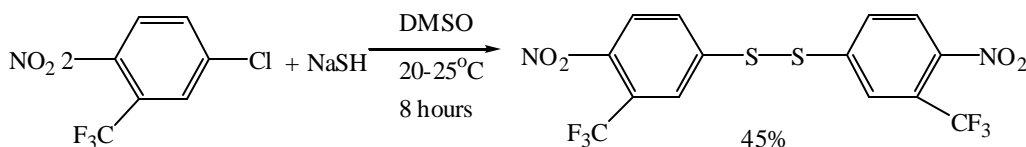

c) Sulfonate displacement

Sulfonates (tosylates) can be displaced by using either sodium sulfhydryte or sodium sulfide in DMSO. Thus, 1,1-dihydrotrifluoroethyl p-toluene sulfonate reacts with sodium sulfide to give bis(1,1-dihydrotrifluoroethyl) sulfide (489):

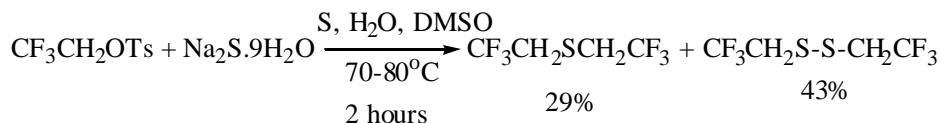

17. Thiocyanate Ion

Sodium and potassium thiocyanates are very soluble in DMSO, and in most cases, the rate constants in displacement reactions are considerably greater than for reactions in protic solvents, e.g. methanol (471).

a) Aliphatic halide displacement

The reaction of 2-bromooctane with potassium thiocyanate yields 2-octyl thiocyanate (472):

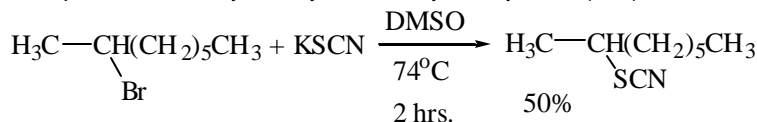

3-Bromocyclohexene reacts with potassium thiocyanate in DMSO to form 3-thiocyanocyclohexene which is labile and rearranges to 3-isothiocyanocyclohexene (390):

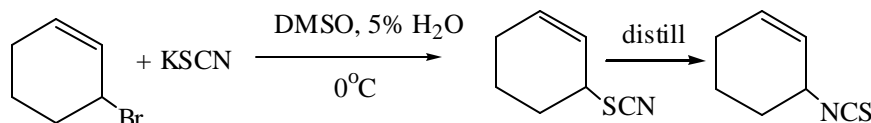

Ammonium thiocyanate and 2-chloromethylbenzimidazole in DMSO react to form thiocyanic acid (2benzimidazolyl)methyl ester (7173):

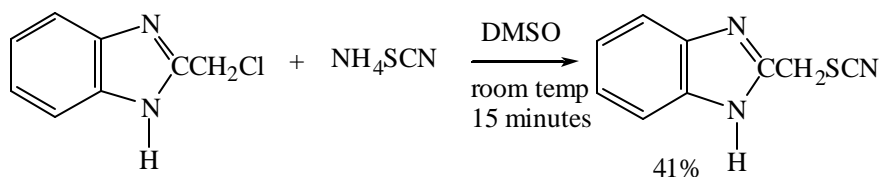

b) Aromatic halide displacement

Nitrotrifluoromethylchlorobenzenes react with sodium thiocyanate in DMSO to yield the corresponding phenylthiocyanates (4123)(7158):

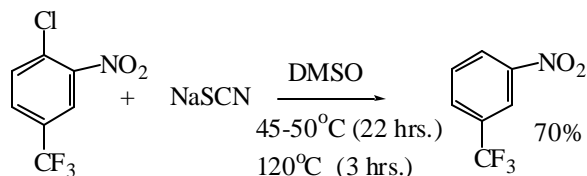

c) Sulfonate displacement

Potassium thiocyanate in DMSO displaces the sulfonate groups from 2,4-pentane di-p-bromobenzenesulfonate to give 2,4-dithiocyanopentane (515):

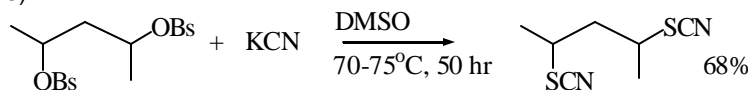

Similarly, 2-methylbutyl p-toluenesulfonate and potassium thiocyanate in DMSO yield (62.5%) 2-methylbutyl thiocyanate (5435).

B. BASES AND BASE-CATALYZED REACTIONS IN DMSO

Basicities in DMSO

The reactivity of nucleophiles in DMSO mixtures with water or alcohols consistently increases as the content of DMSO in the mixture increases. When the nucleophile is the hydroxide ion in the aqueous system, or the alkoxide ion in the alcoholic system, the activities of the bases can be presented in terms of acidity function, shown in Figure 10. Since the acidity function is a logarithmic scale measuring the ability of the system to remove a proton from the reference indicator, the data show the basicity to be enhanced some 10^{14} fold upon going from water or alcohol to 99% DMSO. Such a protic-aprotic system offers a means of adjusting the basicity of a reaction medium over a wide range.

In the highly basic systems, obtained when the concentration of water or alcohol is low, an equilibrium amount of the DMSO anion will be present. The simple aliphatic alcohols are about 1,000 times as acidic as DMSO and they have about the same acidity as triphenylmethane (734)(1558). One chemical consequence of this effect shows up in the alkoxide-catalyzed autoxidation of fluorene where the oxidation rate is controlled by the rate of carbanion formation (1728). The reaction rate increases 220-fold upon changing the solvent from t-butanol to an 80:20 DMSO-t-butyl alcohol mixture. However, in the 80:20 mixture the concentration of DMSO anion is sufficient to react with the product so that instead of a 91% yield of fluorenone a 78% yield of the DMSO adduct of fluorenone is obtained.

Although the equilibrium amount of DMSO anion produced by alkoxide ion in this system is small, the rate at which the protons transfer is fast (1758)(1759) so that a steady pool of DMSO anion is available for reaction.

Proton Removal

A number of different reactions require the removal of protons from carbon with the resultant formation of carbanions. The proton removal can be either an initial or the rate-determining step. Carbanions are formed in racemizations, in isomerizations and in a wide variety of elimination reactions. Just as the equilibrium basicity of alkoxides and hydroxides is enormously enhanced in DMSO versus in hydroxylic solvents, so also is the rate at which proton removal or hydrogen exchange reactions occur in DMSO. The rate of potassium t-butoxide-catalyzed hydrogen-deuterium exchange at a benzylic carbon atom is 10^6 times greater in DMSO than in t-butanol (606).

A similar rate enhancement is observed in racemizations using ammonia as the base, with the reaction being 10^6 - 10^7 times faster in DMSO than in t-butanol (622)(524). The influence of the cation is greater in DMSO than in t-butanol. For example, in t-butanol, sodium and potassium t-butoxides are about equally effective in prompting hydrogen exchange, whereas in DMSO the potassium salt gives a reaction rate one hundred times that of the sodium salt (606).

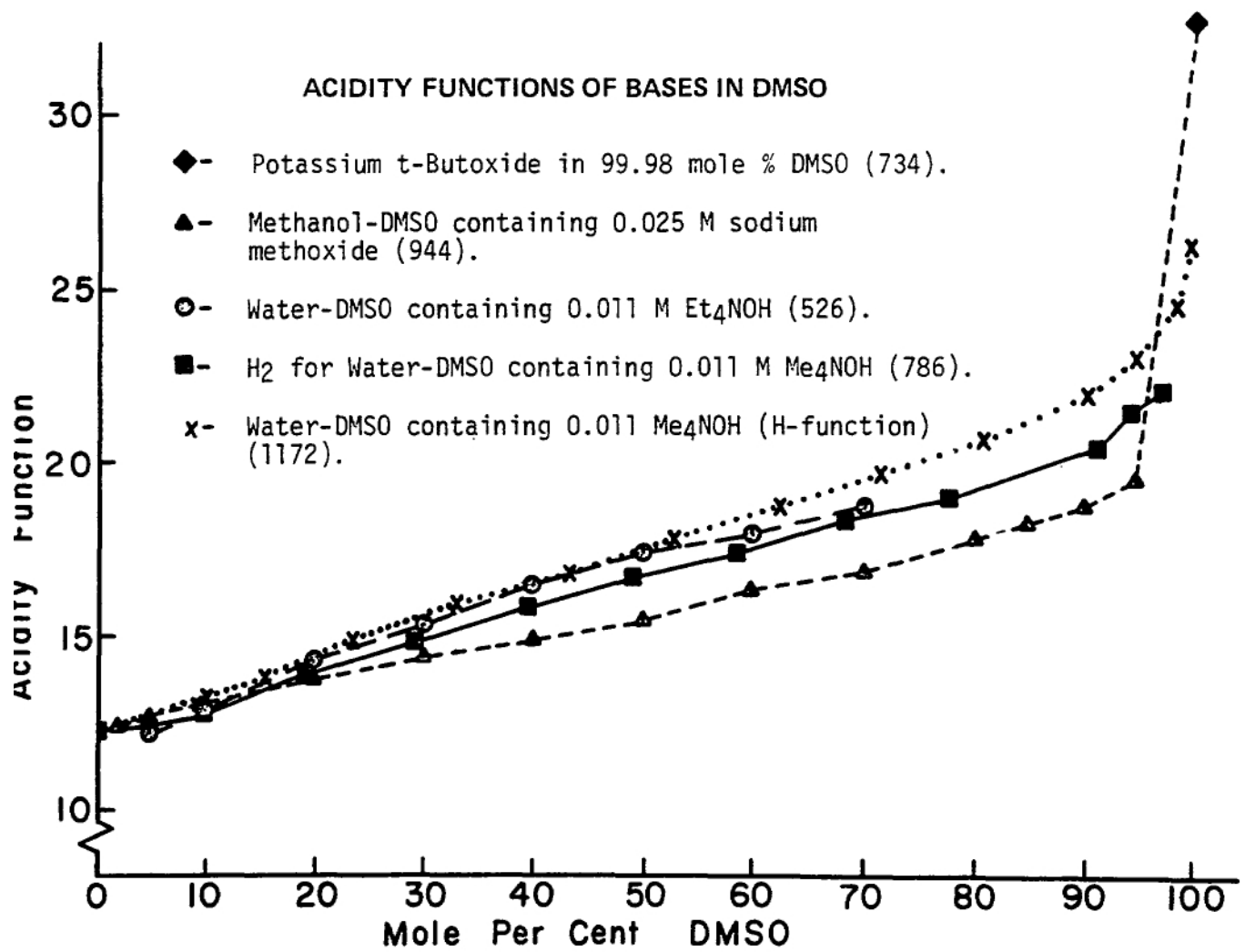

FIGURE 10

The table below (Table XI) lists the acidities (pKa) values of 132 organic compounds in DMSO, starting with the most acidic-protonated pyridine, and ending with the least acidic-propionitrile (10569). The pKa of DMSO is 35 (10411).

TABLE XI
Acidities in DMSO

COMPOUND	pKa	COMPOUND	pKa
Protonated pyridine	3.5	Nitromethane	17.2,16.5
2,6-Dinitro-4-chlorophenol	3.6	Diphenylacetone	17.5
Protonated aniline	3.7	a, a, a', a'-Tetraphenylacetone	17.6
Protonated 2-methylpyridine	4.0	Phenyl benzyl ketone	17.7
Protonated 2,4-dimethylpyridine	4.5	Bis(2-nitrophenyl)amine	17.7
Protonated o-phenylenediamine	4.8	Nitrocyclobutane	17.8
Thiosalicylic acid	5.2	9-Phenylfluorene	17.9
Phthalic acid I	6.2	Nitrocyclohexane	17.9
Oxalic acid I	6.2	Nitroneopentane	18.1
Sulfamic acid	6.5	a, a-Diphenylacetophenone	18.7
Salicylic acid	6.8,6.6	a-Thiophenylacetone	18.7
Thioacetic acid	6.7	Methyl trifluoromethyl sulfone	18.8
Thiocyanuric acid	6.7	4-Chloro-2-nitroaniline	18.9
Bromocresol green	7.0	4-Nitroaniline	19.2
2,5-Dihydroxybenzoic acid	7.1	a, a-Diphenylacetone	19.4
Phenylsulfonylnitromethane	7.2	Methyl benzyl ketone	19.8
3,5-Dinitrobenzoic acid	7.3	2-Bromofluorene	20.0
2,4-Dihydroxybenzoic acid	7.5	Ethyl trifluoromethyl sulfone	20.4
Rhodanine	7.7	Thiourea	20.5
Nitromethyl phenyl ketone	7.7	Thiophenylacetone	20.8
9-Cyanofluorene	8.3	Bis(n-chlorophenyl)amine	21.4
2,5-Dihydrophthalic acid	8.3	Phenylacetone	21.9
Protonated tributylamine	8.3	9-Methylfluorene	22.3
Protonated diphenylguanidine	8.6	Phenylacetylene	22.6,28.8
Chloroacetic acid	8.9	2,6-Dichloroaniline	22.6
p-Nitrobenzoic acid	9.0	Fluorene	22.6
Ethyl nitroacetate	9.2	Trithiophenylmethane	22.8
Thiophenol	9.8	Phenyldithiophenylmethane	23.0
Protonated dibutylamine	10.0	1-Phenyl-1-cyanoethane	23.0
Bromo thymol blue	10.2	3-Methylfluorene	23.1
p-Chlorobenzoic acid	10.2	2,4-Dichloroaniline	23.4
9-Carboxymethylfluorene	10.2'	3-Methoxy-1-propyne	23.5
9-Phenylsulfonylfluorene	10.3	Formamide (N-H)	23.5
Protonated piperidine	10.6	Diphenylamine	23.5,23.6
Protonated pyrrolidone	10.8	Dibenzyl sulfone	23.9
Benzoic acid	10.8,10.9	N,N-Dimethylprop-2-ynylamine	24.2
o-Toluic acid	11.0	9-tert-Butyl-fluorene	24.3
m-Toluic acid	11.0	Ethyl phenyl ketone	24.4
Malononitrile	11.1	Diphenylmethylphenyl sulfone	24.5
p-Toluic acid	11.2	2,5-Dichloroaniline	24.6
3-Nitro-1-propene	11.2	Acetophenone	24.7
Phenylacetic acid	11.6	Urea	25.1
Thiophenylnitromethane	11.8,11.9	2,4-Dichloroaniline	25.3
Phenylnitromethane	12.2	Acetamide (N-H)	25.5
Methylmalononitrile	12.4	Methyl benzyl sulfone	25.6
Acetic acid	12.6	1,3,3-Triphenylpropene	25.6
2-Thiohydantoin I	12.8	Isopropyl phenyl ketone	26.3
Acetylacetone	13.6	Acetone	26.5
Hydrogen cyanide	13.7	9-(3-Chlorophenyl)xanthene	26.6
Bis(ethylsulfonyl)methane	14.4	3-Chloroaniline	26.7
2,4-Dinitroaniline	14.8	Diphenylthiophenylmethane	26.7
Oxalic acid II	14.9	Nitrocyclopropane	26.9
Resorcinol	15.3	Diethyl ketone	27.1
9-Phenylthiofluorene	15.4	9-Phenylxanthene	27.9
2,5-Dihydrophthalic acid II	15.6	Water	28.0
Nitrocycloheptane	15.8	Benzyl methyl sulfoxide	29.0
Nitrocyclopentane	16.0	Methyl phenyl sulfone	29.0
p-Chlorophenol	16.1	Diphenyldiphenylmethane	29.4
2,5-Dichloro-4-nitroaniline	16.2	Triphenylmethane	30.0,30.6
Nitromethylcyclopropane	16.5	Phenylthiophenylmethane	30.8
Nitroethane	16.7	Ethyl phenyl sulfone	31.0
1,1-Bis(ethylsulfonyl)ethane	16.7	Dimethyl sulfone	31.1
1-Nitropropane	16.8	Acetonitrile	31.3
2-Nitropropane	16.9	Diphenylmethane	32.3
Phenol	16.9	Propionitrile	32.5
m-Cresol	17.0	DMSO	35

ELIMINATION REACTIONS

These are base-catalyzed reactions in which two atoms or groups are removed or eliminated, usually from one or two carbon atoms. A double bond is frequently formed as the result of this elimination.

1. Cope Elimination

The pyrolysis of t-amine oxides (Cope elimination) in dry DMSO proceeds at a convenient rate at 25°C to give 80-90% yields of olefins. Temperatures of 132-138° are usually required in water. In addition, the rates in DMSO are 10,000 times faster than in water (495):

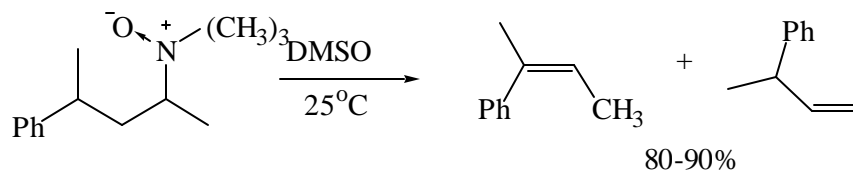

The rate is higher in wet DMSO than in dry THF because DMSO acts as an internal drying agent and competes with amine oxide for the water present (578).

5 α -Stigmasta-7,22,25-trien-3 β -ol, a steroid alcohol, is obtained by heating the appropriate t-amine oxide in DMSO (3481):

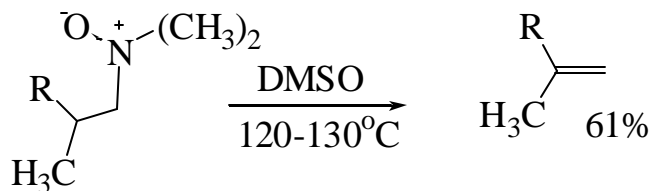

2. Decarboxylation and Decarbalkoxylation

DMSO promotes the decomposition of malonic (640), oxalic (604), and oxamic (643) acids at elevated temperatures, e.g. 140-160°C. Pyridylacetic acid hydrochloride decarboxylates in DMSO at moderate temperatures. The only product of this decarboxylation is 4-methyl-pyridine hydrochloride (2343)(3743):

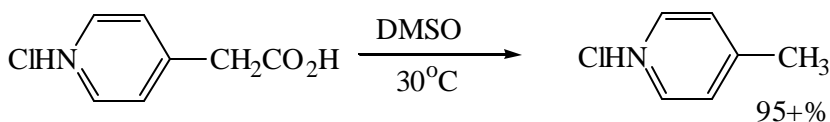

The decarboxylation of trichloroacetic acid also occurs as low as 25.0°C in the presence of DMSO and water. The reaction rate constant increases by a factor of 6-7 with a change in concentration of DMSO from 50 to 86%. Dramatic rate accelerations result in the decarboxylation of benzisoxazole-3-carboxylic acids if water is replaced by DMSO (3447):

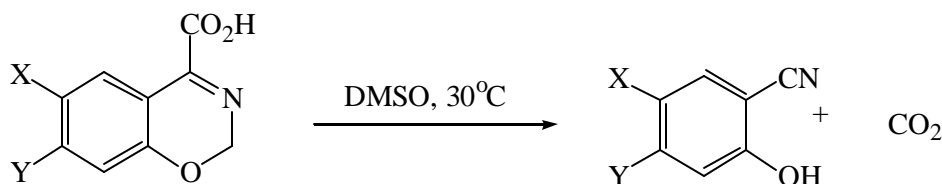

Some acids, such as optically pure (+)-2-benzenesulfonyl-2-methyl-octanoic acid, decarboxylate more readily in the presence of base to give, in this case, (+)-2-octylphenylsulfone in 98% optical purity (631):

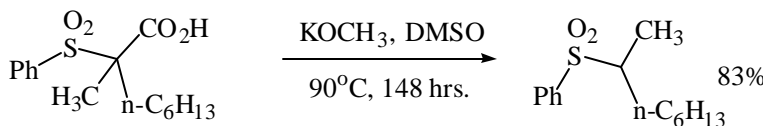

Tetrahalophthalic acids in DMSO in the presence of alkali and alkaline earth chlorides undergo double decarboxylation to form 1,2,3,4-tetrahalobenzenes, whereas, in the presence of other chlorides (e.g. CoCl₂, NiCl₂, CuCl₂) or no salts at all mostly single decarboxylation occurs to give 2,3,4,5-tetrahalo-6-hydroxybenzoic acid (4602). Lead tetraacetate has been used in DMSO to decarboxylate dicarboxylic acids (5081). Thus, the treatment of 3,3-dimethylcyclohex-4-ene-1,2-dicarboxylic acid yields 3,3-dimethyl-1,4-cyclohexadiene (7533):

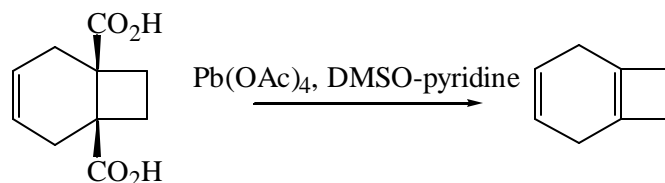

Rates of decarboxylation are reported for several phenylmalonic acids and esters in DMSO at 55.4°C. Only those compounds bearing at least one carboxylic proton are labile, which establishes that intramolecular proton transfer is an integral part of the reaction mechanism (7655).

Benzaldehydes can be prepared from the phenylacetic acids by electrolytic decarboxylation and oxidation in DMSO in the presence of sodium hydride. The yields are good in most cases (8766):

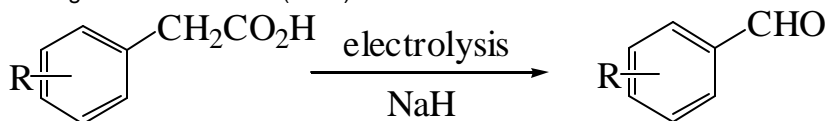

Decarbalkoxylation (mostly decarbethoxylation) is related to decarboxylation in that the $-\text{CO}_2\text{R}$ group, instead of CO_2 (decarboxylation) is eliminated. Thus, geminal dicarboxy groups are eliminated when malonic ester derivatives are heated in DMSO (942):

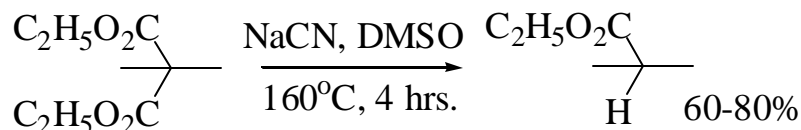

The treatment of ethyl trichloroacetate with sodium methoxide in DMSO at 0°C produces dichlorocarbene which is oxidized by DMSO (1040).

Decarboxylation of geminal diesters, β -keto esters, and α -cyanoesters to the corresponding monoesters, ketones and nitriles can be accomplished in excellent yields (85-95%) in wet DMSO in the presence of sodium chloride at 140-186°C (6102)(7022)(9769). Other dipolar aprotic solvents, such as DMF, are less effective in the case of substrates with lower activity because of lower boiling points of these solvents (6102).

The alkylative decarboxylation of N-carbalkoxy-pyrazoles has been shown to require a polar aprotic solvent, such as DMSO, and to be subject to catalysis by nucleophiles, e.g. halide ions (7285):

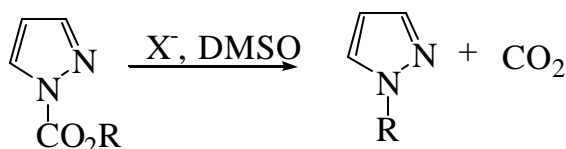

The decarbalkoxylation of methyl or ethyl isohexylmalonates in DMSO in the presence of various alkali metal salts gives methyl or ethyl 6-methylheptanoates. The best results are obtained in the presence of 1 equivalent of salt and 2 equivalents of water (8861). Salts such as KCN, NaCl, or LiCl dramatically enhance the decarbalkoxylation rates of geminal diesters, β -keto esters, and α -cyanoesters by DMSO-water (9769).

3. Dehalogenation

By a proper choice of reaction conditions or nucleophile in DMSO, one can obtain elimination of either bromine or hydrogen bromide in cases where both paths are available (454):

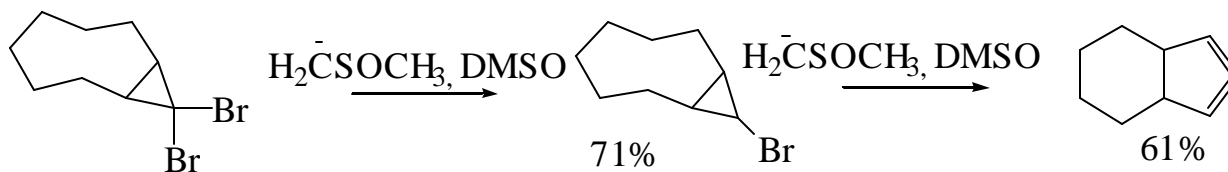

In the presence of excess dimethyl sodium in DMSO at room temperature, the debrominated intermediate results, while the use of a larger excess of dimethyl sodium and longer reaction times yield 1,2-cyclononadiene.

In the reaction of 3 β -chloro-5 α -bromo-6 β -bromocholestane with excess dimethyl sodium in DMSO, bromine elimination occurs. When this intermediate is treated with potassium t-butoxide in DMSO, HCl elimination occurs (455):

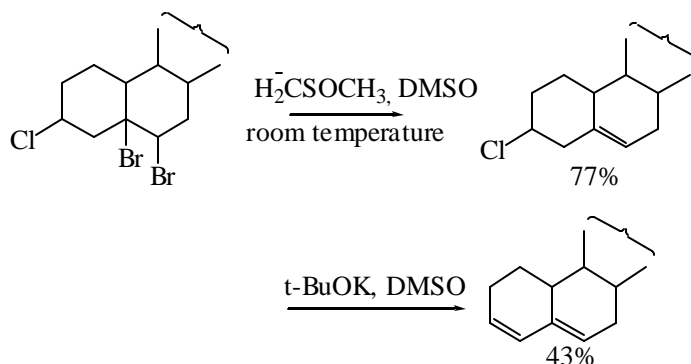

Pure olefins from their dibromides can be obtained by using sodium thiosulfate in DMSO as the debrominating agent. Thus, stilbene dibromide yields stilbene (6496):

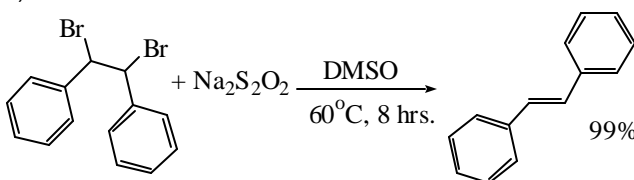

Treatment of 8,9-dibromodispiro[2.0.2.4]decane with potassium t-butoxide in DMSO gives spiro[2.0.2.4]dec-8-ene (7153):

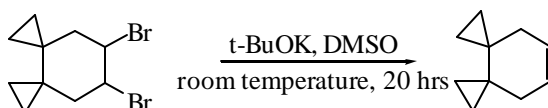

Another dibromide can be dehalogenated by heating with zinc dust in DMSO (7184):

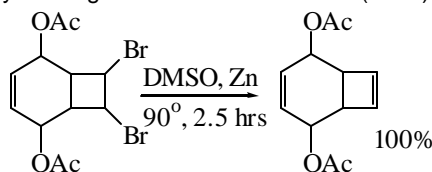

Heating trans- α, β -dibromo derivatives of diphenylethylene and meso-stilbene with potassium fluoride and cesium fluoride in DMSO afford quantitative yields of diphenylacetylene and trans-stilbene, resp., via the intermediacy of dimsyl ion. These reactions do not occur in N-methylpyrrolidone, DMF, or sulfolane (9338):

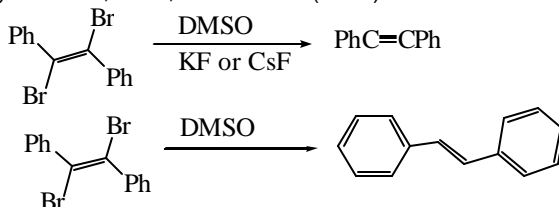

The action of zinc-copper couples on perfluoroiodoalkanes, $\text{C}_4\text{F}_9\text{I}$, $\text{C}_6\text{H}_{33}\text{I}$ and $\text{C}_8\text{F}_{17}\text{I}$, has been studied in aprotic solvents, such as DMSO. A mixture of perfluoroolefins results (9928), e. g.

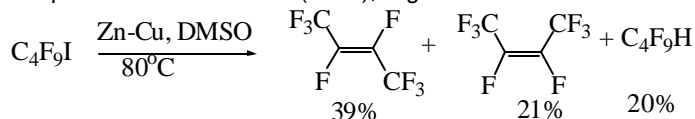

Some dehalogenation reactions using potassium t-butoxide as the base have been reviewed (6815).

4. Dehydrohalogenation

A variety of bases have been used in the dehydrohalogenation reaction. The most frequently used base has been potassium t-butoxide, followed by other alkoxides. Other bases used include: sodium and potassium hydroxide the carbonate and bicarbonate ions, quaternary ammonium hydroxide, dimethyl ion, sodium cyanide and some relatively weak organic bases, such as ammonia and amines. The effects of base strength and size upon the orientation in base-promoted β -elimination reactions have been studied (6234)(6378)(6818)(8582)(10011).

Ionic association in base-promoted β -elimination reactions has been reviewed (8050).

a) Potassium t-butoxide in dehydrohalogenations

The enhanced basicity of potassium t-butoxide in DMSO has been suggested as the dominant factor which causes dehydrobrominations to occur much more readily in DMSO than in t-butanol (652).

The reaction of benzhydryl chloride with potassium t-butoxide in t-butanol occurs slowly by displacement giving benzhydryl t-butyl ether, whereas the base in DMSO causes a very rapid elimination (α -elimination) giving nearly quantitative yields of tetraphenyl ethylene (696). The rapid reaction is suggested to occur by an initial formation of the carbanion which eliminates chloride ion to give a carbene intermediate, as shown below:

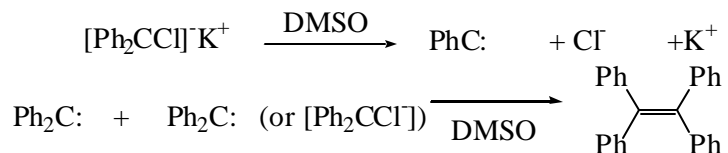

The rate of dehydrobromination of 2-arylethyl bromides with potassium t-butoxide in t-butanol-DMSO mixtures increases with increasing DMSO concentration at a much faster rate than the increase of acidity function (833).

The strongly basic reaction medium obtainable with potassium t-butoxide in DMSO in the case of aromatic bromine compounds produces aryne intermediates (434)(514) (see also Displacement reactions Alkoxide Ion, Aromatic halide displacement, p. 20).

2,7-Dichlorobicyclo[2.2.1]heptane on treatment with potassium t-butoxide in DMSO gives 7-chlorobicyclo[2.2.1]heptene (3360):

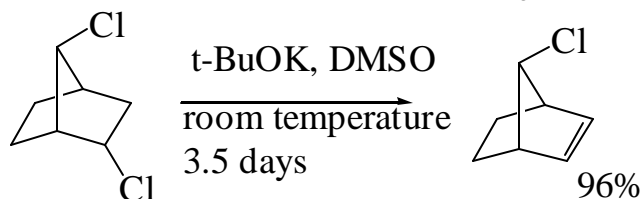

Olefinic products from reactions of a series of 2-bromoalkanes with potassium t-butoxide are produced. The trans:cis 2-alkene ratio is dependent upon the alkyl group of the 2-bromoalkane (3368):

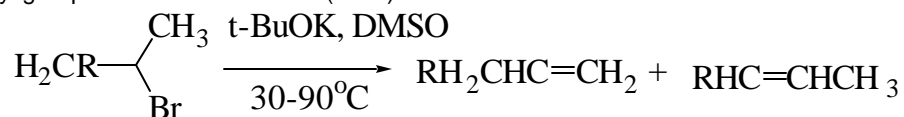

The trans-1-iodocyclopropylpropene reacts at least ten times faster with potassium t-butoxide in DMSO than the cis isomer to yield 1-cyclopropyl-2-methylacetylene (3503)(4176):

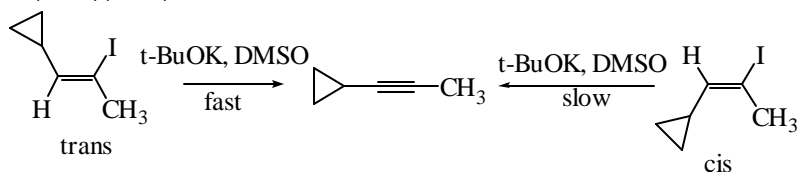

Six or seven-membered trans-cycloolefins may be transformed into the corresponding 3-alkoxycycloalkynes by reaction with potassium t-butoxide in DMSO (3707):

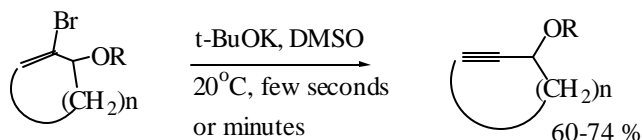

n = 5 or 6

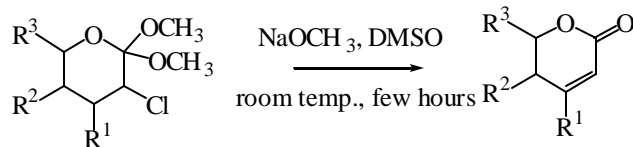

The addition of DMSO to the NaOCH-CH₃OH medium causes a significant increase in the rate of dehydrochlorination of Ph₂CHCH₂Cl (9142)(9143). Although double dehydrobromination of 2,6,6-bis-(ethylenedioxy)-3,7-dibromobicyclo[3.3.0]octane with ethanolic potassium hydroxide requires refluxing for several days for complete reaction, the elimination may be effected in several hours with sodium methoxide in DMSO (9604):

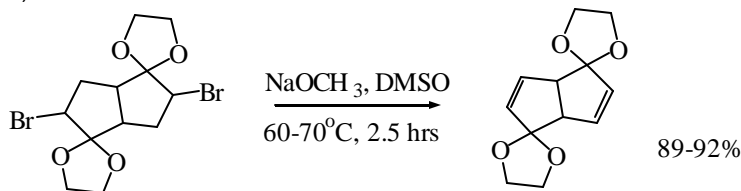

c) Dimsyl ion in dehydrohalogenations

Treatment of 1-acetylnaphth-2-yl 2'-chloroallyl ether with dimsyl ion in DMSO yields 1-acetylnaphthyl-2-yl propargyl ether which cyclizes to 2-methyl-1,4-phenanthrenequinone (7552):

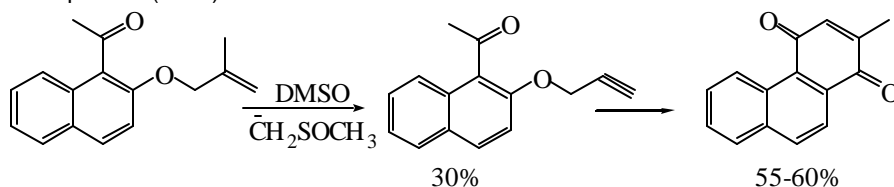

Reaction of 2,2-dimethyl-3-chloro-3-butenoic acid with dimsyl sodium in DMSO gives 2,2-dimethyl-3-butynoic acid (7865):

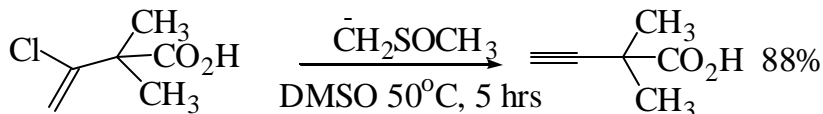

In some cases, potassium t-butoxide is a better dehydrohalogenating agent than the dimsyl ion. Thus, the dimsyl ion can act as a dehalogenating agent for vicinal dibromides (455):

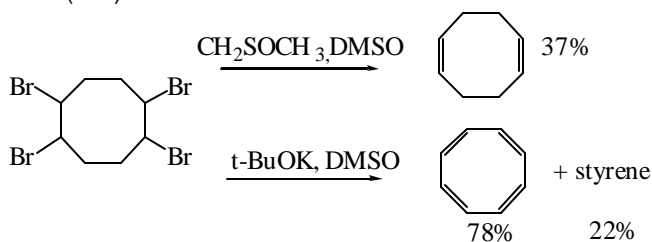

d) Hydroxylic bases in dehydrohalogenations

Hydroxylic bases, such as sodium hydroxide, potassium hydroxide and tetraalkylammonium hydroxide have been used for β-dehydrohalogenation reactions (8050). Tetra methylammonium hydroxide is more soluble in DMSO than either sodium hydroxide or potassium hydroxide (see Table IX). Thus, 1,1,1-chlorodifluoroethane can be dehydrochlorinated to vinylidene fluoride in high yield in heterogeneous DMSO suspensions or aqueous DMSO suspensions or solutions in the presence of sodium hydroxide, potassium hydroxide or tetramethylammonium hydroxide (5279), e.g.:

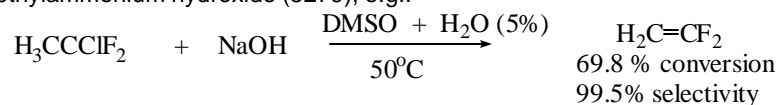

DMSO is a better reaction medium for the above reaction than some other solvents.

Methyl halogenated ethyl sulfides can be dehydrohalogenated with potassium hydroxide in DMSO (3142), e.g.

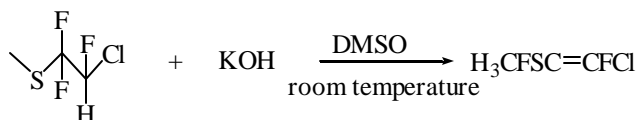

6-Hydroxy-2-isopropenyl-5-acetylcoumaran can be obtained from the corresponding vinyl bromide by dehydrohalogenation with potassium hydroxide and cyclization in DMSO (4892):

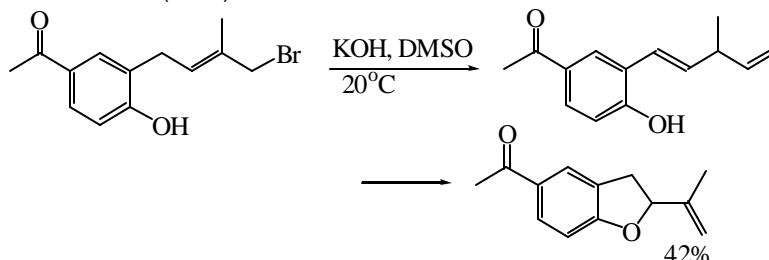

Relatively high yields of alkynes can be obtained from α, β -dihalides or α, α -dihalides in short reaction times at moderate temperatures in DMSO using moderately strong bases, such as potassium hydroxide, without isolation of the intermediate olefin (8238), e.g.:

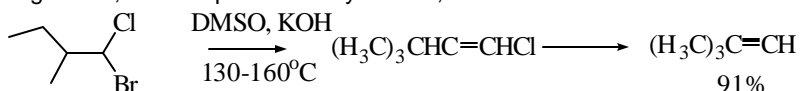

e) Weak bases in dehydrohalogenations

Although potassium *t*-butoxide in DMSO is an extremely strong and reactive base-solvent system, sometimes undesirable reactions take place after dehydrohalogenations. Thus, the freshly formed olefins tend to isomerize, and carbanions can be generated which can decompose in various ways (4180)(6163).

Dehydrohalogenations without olefin isomerization can sometimes be accomplished by using weaker bases, such as carbonates, cyanides, or amines.

Thus, the treatment of 1,3-dibromo-1,3-diphenylcyclobutane with sodium cyanide in DMSO produces 1,3-diphenylcyclobut-2-enyl cyanide (4077):

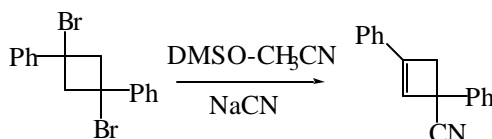

In the above reaction, both the β -elimination and displacement (substitution) reactions take place.

3,3-Dibromo-6-dibromomethyl-5-carbomethoxy-2,3-dihydro-2-methyl-4H-pyran-4-one with sodium carbonate in DMSO yields 3-bromo-6-dibromomethyl-5-carbomethoxy-2-methyl-4H-pyran-4-one (6215):

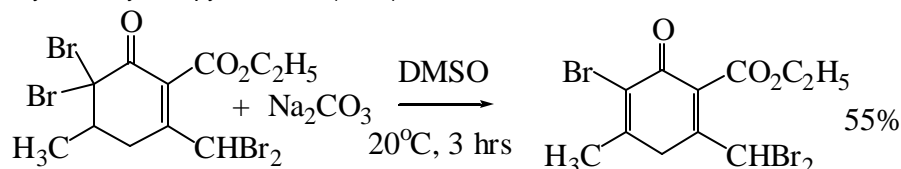

3-Alkylthio- or 3-arylthio-4-chlorothioline 1,1-dioxide can be dehydrohalogenated when warmed with triethylamine in DMSO (385):

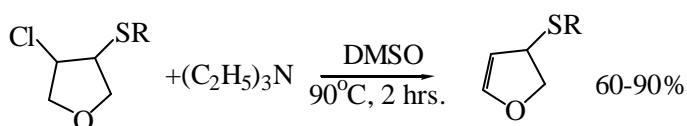

5. Nitrogen Elimination

Elemental nitrogen can be eliminated from a number of compounds by heating in DMSO in the presence or absence of bases. Usually these are compounds that contain the nitrogen-nitrogen bond, such as hydrazones, hydrazides, carbazides, azo compounds,

diazomethane derivatives, azides, diazonium salts and others.

Addition of hydrazones of aldehydes and ketones to a solution of potassium t-butoxide in DMSO produces an immediate evolution of nitrogen and formation of the corresponding hydrocarbons in 60-90% yields. The reaction of the benzophenone hydrazone is typical (495).

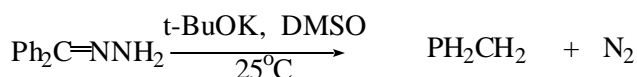

The above reaction, the so-called Wolff-Kishner reduction in DMSO, can be run even at room temperature.

The rate of the Wolff-Kishner reaction of benzophenone hydrazone in mixtures of butyl carbinol and DMSO in the range of 100-190°C increases as the concentration of DMSO is increased, but this effect passes through a maximum. The maxima tend to drift toward higher DMSO concentrations as the temperature is lowered (377).

The thermal decomposition of norbornan-2-one and norborn-5-en-2-one tosylhydrazone sodium salts has been studied over the temperature range 100-150°C in DMSO and two other solvents. First order kinetics have been observed in all cases (8955):

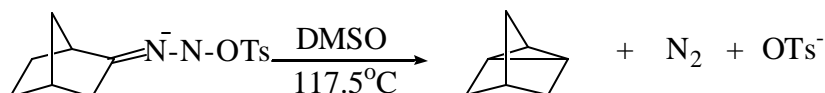

Treatment of 1-acylsemicarbazides in DMSO with air or oxygen gives rise to carboxamides in good yields (3721):

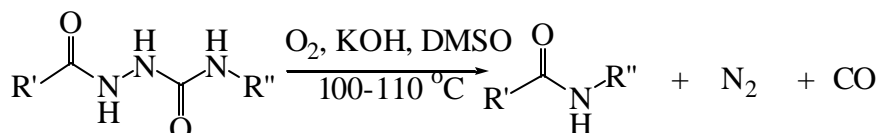

Thermal decomposition of two azobisamidines and their conjugate acids has been studied in DMSO (4748).

Rate coefficients are reported for the reaction of diazodiphenylmethane with benzoic acid and its orthosubstituted derivatives in DMSO and other solvents (2765):

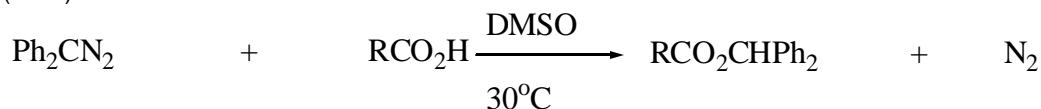

Thermal decomposition of several diazirines has also been investigated in DMSO (4906)(5635), e.g.

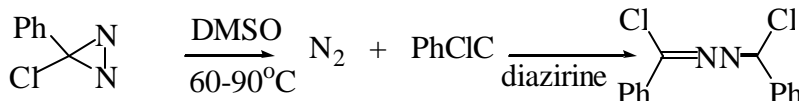

Sodium azide in DMSO reacts with α -bromophenylacetonitrile to yield benzonitrile (10077):

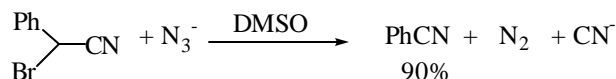

Diazonium salts can be prepared in DMSO by diazotizing primary amines with sodium nitrite. In the case of benzylamine, benzaldehydes can be prepared in good yields (167), e.g.:

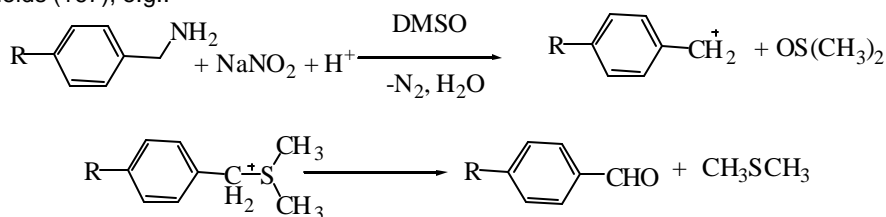

Benzenediazonium tetrafluoroborate in DMSO decomposes instantaneously with evolution of nitrogen upon addition of a DMSO solution of choline or tetramethylammonium hydroxide (5124):

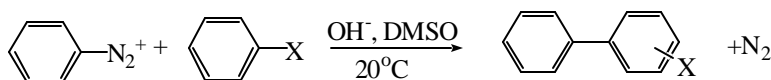

When p-nitrobenzenediazonium tetrafluoroborate is decomposed in the presence of DMSO-benzene or DMSO-nitrobenzene systems, the respective biphenyl derivatives are obtained in good yields (5642).

The dediazotization of aromatic diazonium ions has been reviewed in various solvents, including DMSO (9423).

6. Sulfenate Elimination

The t-butoxide ion or dimethyl sulfide ion in DMSO has been used to eliminate sulfenates from sulfoxides to produce olefins in moderate to high yields (501)(203)(672). When a number of 3-phenyl-2-alkylpropyl sulfoxides is allowed to react in DMSO with a large excess of dimethyl sodium, cyclopropanes and olefins are formed (396)(2842):

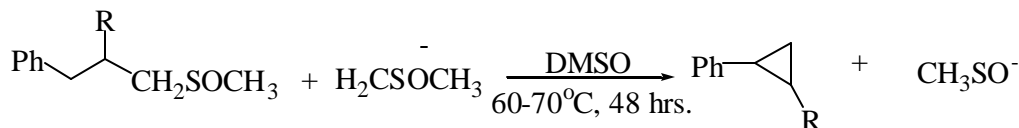

When isomeric 2-phenylsulfinyl-1,2-diphenyl-1-ethanols are pyrolyzed in DMSO in the presence of trace quantities of pyridine, deoxybenzoin is formed (4776):

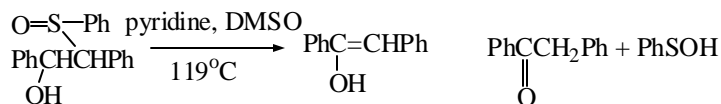

3-Phenylindole is obtained from β-hydroxysulfoxide on treatment of the latter with dimethyl ion in DMSO (5300):

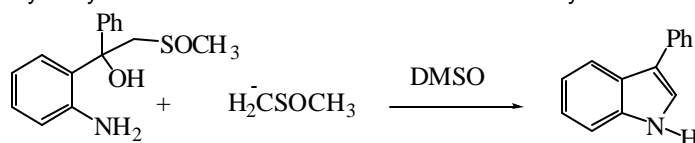

7. Sulfonate Elimination

Various bases have been used in the reaction of sulfonate esters of primary and secondary alcohols to give alkenes. Some of these bases are potassium t-butoxide, sodium methoxide, potassium ethoxide, phenoxides, and others. In a few cases, elimination reactions involving sulfonate esters have been achieved without the presence of a base by the action of heat alone.

a) Potassium t-butoxide in sulfonate elimination

Most β-eliminations involving sulfonate esters seem to have been investigated with potassium t-butoxide as the base. Sulfonate esters of cyclic and secondary acyclic alcohols react rapidly with potassium t-butoxide in DMSO at 20-25°C to give about 80% yields of alkenes and no appreciable quantities of ethers. Esters of normal primary alcohols and of cyclohexylcarbinol give only 20-25% alkenes and 60-70% ethers, as the result of displacement reactions in the latter case (491).

Mesylate and tosylate derivatives of cholesterol, all easily prepared, undergo facile reactions in DMSO at room temperature to afford excellent yields of dienic materials (965).

Treatment of the tosylate of (+)-(S)-3-methyl-7-deutero-octen-4-ol-7 with potassium t-butoxide in DMSO yields (+)-(S)-cis,trans-3-methyl-7-deuterooctadiene-4,6 (3482):

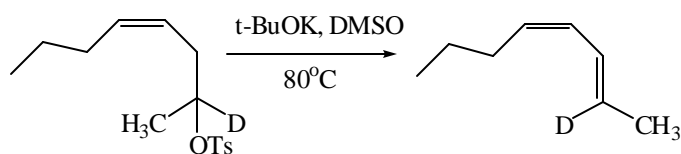

The tosylate of cyclohexanol-2,2,6,6-d₄ on treatment with potassium t-butoxide gives cyclohexene-1,3,3-d₃ (3584) :

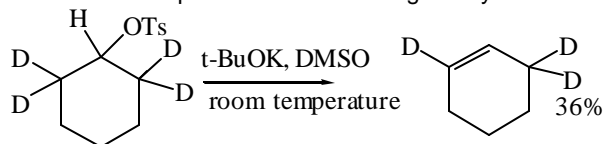

5,6 Dimethylenebicyclo[2.2.0]hexene-2, the Dewar o-xyllylene, can be obtained by reacting the corresponding ditosylate with potassium t-butoxide in DMSO (3827):

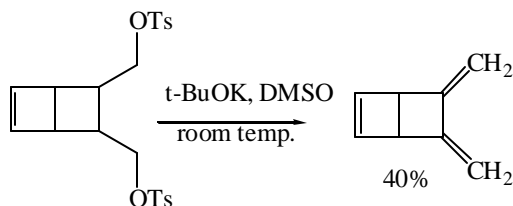

When 4-hydroxy-trans-bicyclo[5.1.0]octane p-bromobenzene-sulfonate is treated with potassium t-butoxide in DMSO, it is rapidly converted to trans-bicyclo[5.1.0]oct-3-ene (4039):

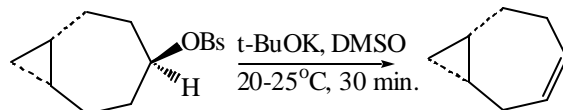

When 2-butyl and 2-pentyl halides or tosylates are treated with tetraethylammonium fluoride in acetonitrile, an olefin forming elimination takes place and an overwhelming Saytzeff orientation is observed. These results are compared with results of the elimination in other base-solvent systems, including potassium t-butoxide in DMSO (4524).

The reaction of trans-2-methylcyclooctyl tosylate with potassium t-butoxide in DMSO for 30 min at 25°C yields cis-3-methylcyclooctene, 93%, and cis-1-methylcyclooctene, 4%. With t-butenol as the solvent, the ratio of the isomers is 2:1.

An approximately equimolar mixture of bicyclo[5.2.0]non-1(9)-ene and bicyclo[5.2.0]non-8-ene is obtained by treatment of 8-methanesulfonyloxybicyclo[5.2.0]nonane with potassium 1-butoxide in DMSO (9727).

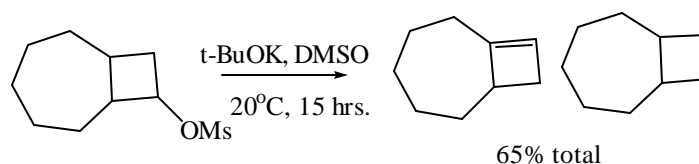

b) Sodium methoxide in sulfonate elimination

Benzenesulfonates of typical primary and secondary alcohols react rapidly at room temperature with sodium methoxide in DMSO to give high yields of alkenes and/or alkyl methyl ethers. Except for cyclohexyl benzenesulfonate, the ether-alkene ratio is higher in reactions with sodium methoxide than with potassium t-butoxide. This indicates that the displacement reactions are favored over elimination reactions with sodium methoxide in most cases (580).

1,3-Dimethoxypropene can be obtained from p-toluenesulfonate of 1,3-dimethoxy-2-propanol by means of sodium methoxide in DMSO in good yield with cis/trans ratio of 2.1:1. Evidently little of the displacement reaction goes on (3875):

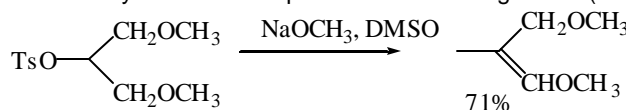

A double bond in a cyclic system, a precursor of dl-juvabione, is introduced by treatment of a tosylate with sodium methoxide in refluxing methanol containing 10% DMSO (6947).

c) Other bases in sulfonate elimination

When cyclohexyl tosylate is reacted with potassium t-butylmercaptide in DMSO, cyclohexene is the major product. However potassium t-butoxide reacts much more rapidly than the mercaptide (496).

The effect of base strength upon orientation in base prompted elimination reactions has been studied. 2-Butyl p-toluenesulfonate is reacted with the following bases in DMSO: potassium t-butoxide, potassium ethoxide, potassium phenoxide, potassium 4-methoxyphenoxide, potassium 4-nitrophenoxide and potassium 2-nitrophenoxide. The results are completely consistent with a correlation between orientation and base strength (882).

The trans:cis olefin ratios have been determined for the elimination reactions of 1-benzyethyl tosylate, $\text{PhCH}_2\text{CH}(\text{OTs})\text{CH}_3$, in different base-solvent systems. The basicity of the nucleophile does not appear to significantly affect the trans:cis ratio (8372).

d) Sulfonate elimination without a base

DMSO has been found to be an excellent non-reacting solvent for the decomposition of (-)-menthyl, β -cholestanyl, cyclohexyl and 2-octyl aryl-sulfonates to the corresponding olefins. The sulfonates are heated at 89-91°C for 6 hours without a base (408).

The elimination reactions of some secondary acyclic and medium sized ring cyclic alcohol tosylates carried out in DMSO at 50°C and 90-95°C show that olefins are formed, especially with secondary alcohol tosylates.

8. Water Elimination-dehydration

Many alcohols can be dehydrated in DMSO to olefins. Certain diols when heated in DMSO lead to cyclic ethers. A group of tertiary alcohols, such as 2-alkylcycloalkanes, at 160-190°C for several hours in DMSO give endocyclic olefins, 1-alkylcycloalkenes, as the major products. Thus, 1-methylcyclopentanol gives only 1-methylcyclopentene (394):

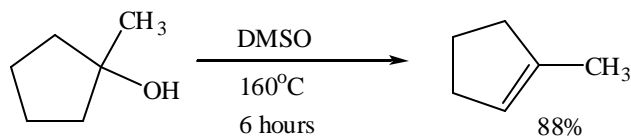

When certain diols are heated in DMSO, cyclic ethers result instead of the expected dienes (395). When 1,4-butanediol, 1,5-pentanediol and 1,6-hexanediol are heated, using 2 moles of alcohol per mole of DMSO, the corresponding heterocycles, tetrahydrofuran (70%), tetrahydropyran (47%), and oxepane (24%) are formed (394):

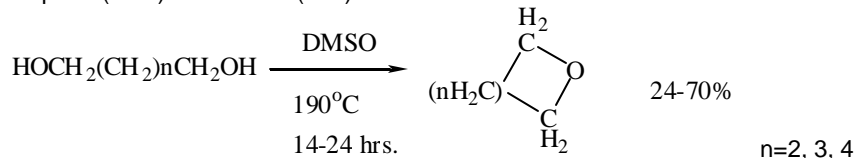

2,4-Di(2-hydroxy-2-propyl)cyclohexene can be selectively dehydrated to 2-(2-propenyl)-4-(2-hydroxy-2-propyl)-1-cyclohexene in DMSO (4775):

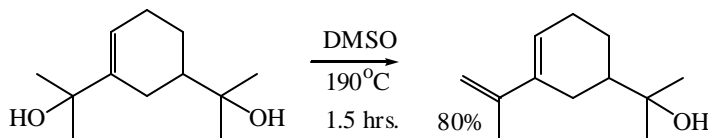

Heating of 2,2,3,3-tetramethylbutane-1,4-diol in a sublimation apparatus in DMSO gives the tetrahydrofuran (4934) :

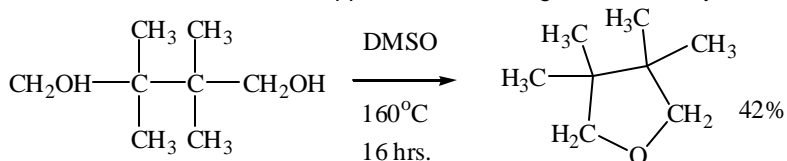

In the dehydration of 1,4-diols, a cyclic transition state with DMSO has been postulated (395)(6098):

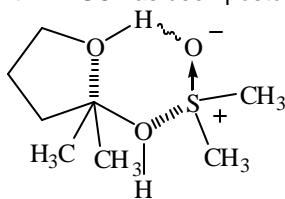

When sec- or tert-benzylic alcohols or tert-aliphatic alcohols are heated in DMSO at 160-185° C for 9-16 hours, dehydration produces olefins in 70-85% yields (405), e.g.

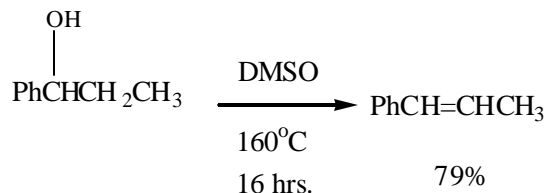

2,2-Dimethyl-3(2H)-furanone can be obtained by dehydrating the corresponding 5-hydroxy compound on heating in DMSO (4755):

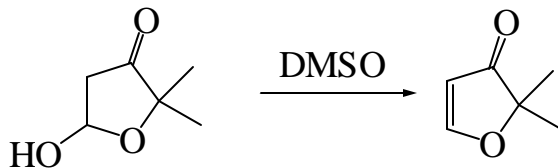

2-Methoxy-4,5-dimethylstilbene is obtained by heating 2-methoxy-4,5-dimethylphenylbenzylcarbinol in DMSO (9605):

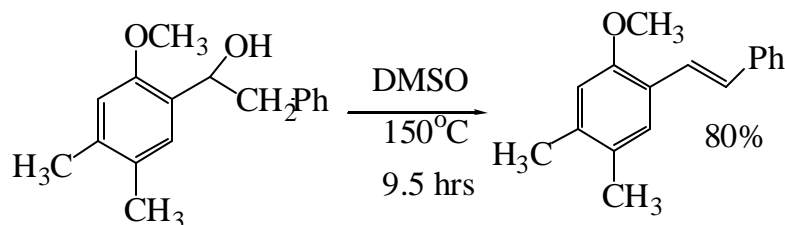

One of the key features of the stereoselective and regioselective total synthesis of two naturally occurring fungitoxic hydroquinones (\pm)-zonarol and (\pm)-isozonarol is the dehydration of a tertiary alcohol to an alkene without rearrangement (9780):

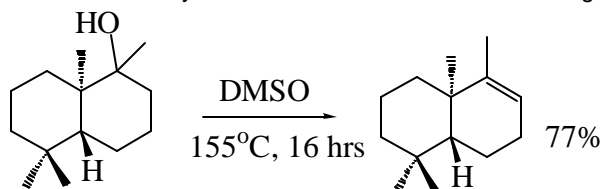

In some cases, the dehydration is achieved in DMSO in the presence of an inorganic acid. Thus, the lactonization of a hydrolyzed terpolymer can be carried out by reacting the polymer in the presence of a very small quantity of concentrated sulfuric acid in DMSO (2265):

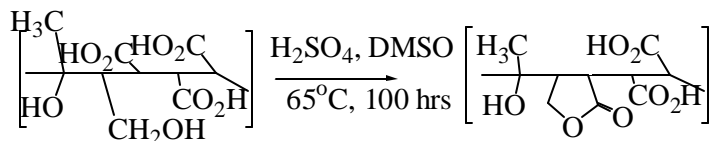

Potassium hydrogen sulfate in DMSO is an effective medium for elimination of water from some intermediate hydroxy derivatives in the preparation of various C₁₉ analogs of retinoic acid (4235):

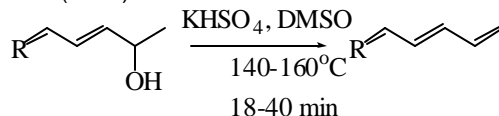

Dehydration of 4-(1-hydroxyethyl) biphenyl in DMSO in the presence of a small amount of potassium hydrogen sulfate and hydroquinone gives p-phenyl-styrene (7867):

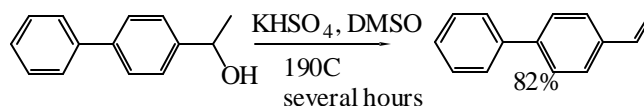

Dehydration of a diol can also be accomplished by using the triethylamine-sulfur trioxide complex in DMSO (7080):

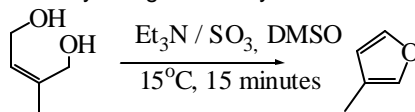

ISOMERIZATION REACTIONS

These are base-catalyzed reactions that convert olefins and other unsaturated compounds into molecules with different atomic arrangement. Included are also racemization reactions: the conversion of half a given quantity of an optically active compound into one enantiomer.

1. Acetylene Isomerization

The enhanced rate of base catalyzed isomerization in DMSO can be used to control the direction of a cyclization of acetylenes (600). When propargyloxyethanol is cyclized in DMSO in the presence of sodium hydroxide, 2-vinyl-1,3-dioxolane and 2-methyl-1,4-dioxene are the major products (101):

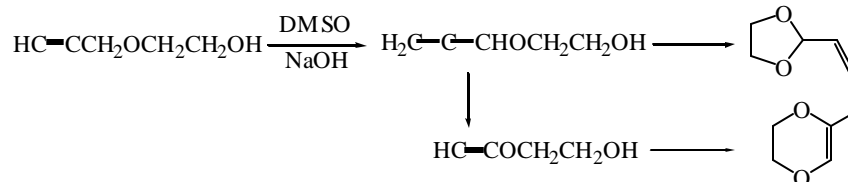

Treatment of an acetylenic compound with potassium tert-butoxide in DMSO gives the corresponding allenic compounds (2239):

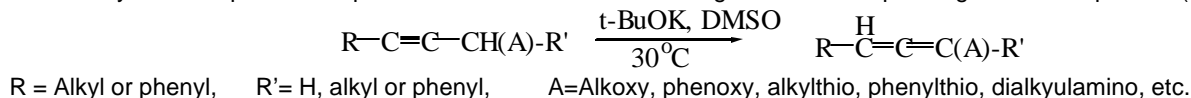

3-Phenylpropyne undergoes in DMSO a dimsily ion-catalyzed isomerization with very little H-D exchange with the solvent (2987):

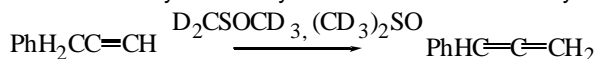

4-Alkoxy-4-alkyl-1-t-butoxy-2-butyne, when heated with catalytic amounts of potassium t-butoxide in DMSO, is isomerized to allenic diethers (4257):

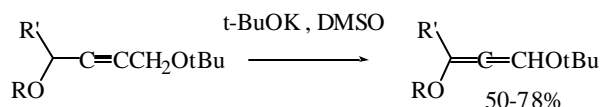

Similarly, 3-alkoxy-1-phenylpropynes are isomerized in DMSO under the catalytic influence of potassium tert-butoxide to give 3-alkoxy-1-phenylallenes (4258):

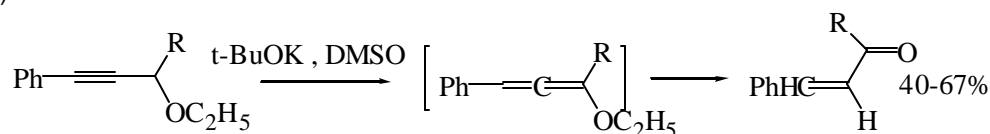

The rates of base-catalyzed isomerization of a series of 1,3,3-triphenylprop-1-yne and [3-²H]-1,3,3-triphenylprop-1-yne, have been measured in aqueous DMSO containing tetramethylammonium hydroxide and give linear correlations with the acidity function for the medium (5864).

Pure 2-alkynes are obtained upon heating 1-alkynes with sodamide in DMSO (6510):

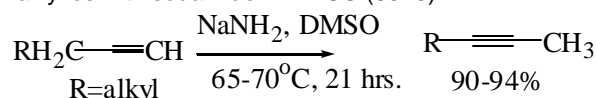

2. Allyl Group Isomerization

The isomerization of allyl ethers to propenyl ethers occurs 1000 times faster in DMSO than in dimethoxyethane and 10,000 times faster than in dimethoxyethane-t-butanol mixtures (481). This facile isomerization of allyl to easily hydrolyzed propenyl groups enables the use of allyl groups as blocking agents (10043). For example, 9-allyladenine is isomerized with potassium t-butoxide in DMSO to the propenyl compound which is then easily hydrolyzed to regenerate the amino group (941):

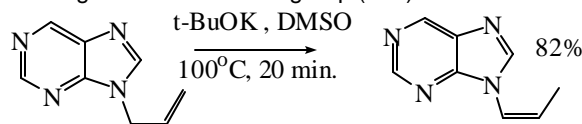

The allyl group of a glycoside can be isomerized to the prop-1-enyl group by the action of potassium t-butoxide in DMSO, without affecting phenyloxazine group (8951):

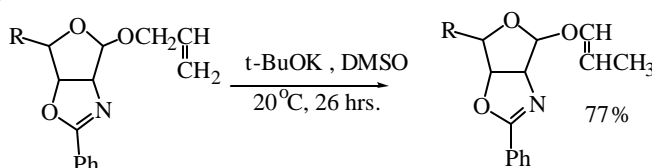

3. Diene, Triene Isomerization

Unconjugated dienes can be converted to the conjugated isomers by treating them with a strong base in DMSO. Thus, the treatment of 2-bromo-1,3-cyclohexadiene (I) with potassium t-butoxide in DMSO yields a mixture of 79% 1-bromo-1,3-cyclohexadiene (II) and 21% of I.

The difference in free energy between I and II appears to be the result of greater conjugation of bromine with cyclohexadiene system in 11 (596):

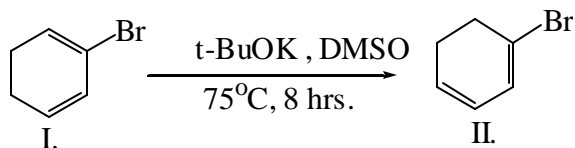

Several unconjugated dienamines on treatment with potassium t-butoxide in DMSO produce the conjugated dienamine by a pivoting of the double bond around the carbon carrying the nitrogen atom (4018):

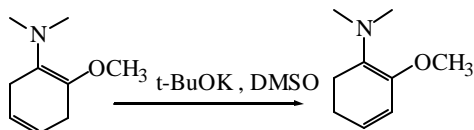

2-Methyl-1-(tetramethylcyclopropylidene)propene is isomerized with potassium t-butoxide in DMSO to give 2-methyl-3-(tetramethylcyclopropylidene)propane (4126):

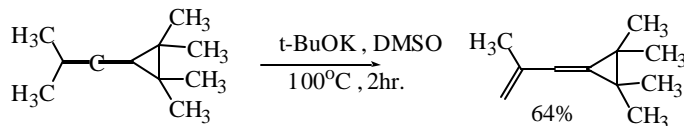

Unsaturated fatty acid esters containing conjugated double bonds are manufactured by isomerization from the esters with unconjugated double bonds by heating them with alkali metal alkoxides in DMSO (8906).

Steroids have been isomerized with a base in DMSO (3272)(2323). Thus, 19-hydroxy- $\Delta^{4,6}$ -3-keto steroids are deconjugated to $\Delta^{4,7}$ -3 ketones by treatment with sodium methoxide in DMSO (4311):

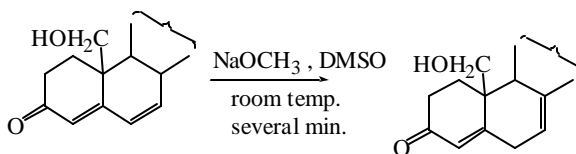

Sodium methoxide catalyzed deconjugation of cholesta-1,4,6-trien-3-one in DMSO to cholesta-1,5,7-trien-3-one is a key step in a reported route to 1- α -hydroxy-vitamin D₃ (10048).

1,3,6-Octatrienes and 1,3,7-octatrienes are isomerized to 2,4,6-octatriene in 70-85% yields with hydroxide bases in DMSO (3379).

4. Olefin Isomerization

The isomerizations of simple alkenes (e.g. pentene-1, hexene-1) with potassium t-butoxide do not occur in tert-butanol, THF or 1,2-dimethoxyethane. However, in DMSO with potassium tert-butoxide as the base, 1-olefins can be converted to 2-olefins, e.g. 2-methylpentene to 2-methylpentene-2 (579):

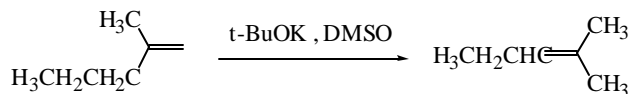

S-(2-propenyl)-L-cysteine is isomerized to cis-S-(1-propenyl)-L-cysteine by reaction in potassium tert-butoxide and DMSO (1001):

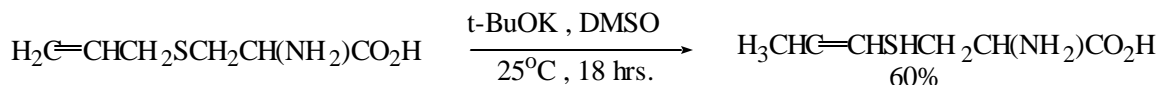

α -Pinene can be converted to β -pinene by using potassium hydroxide and DMSO (480)(7229):

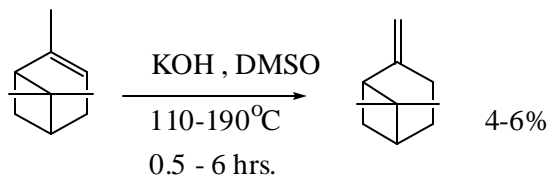

Similarly, (+)-sabinine isomerizes to an equilibrium mixture of 91 % (-)- α -thujene and 9% (+)-sabinine under the influence of potassium t-butoxide in DMSO (2998):

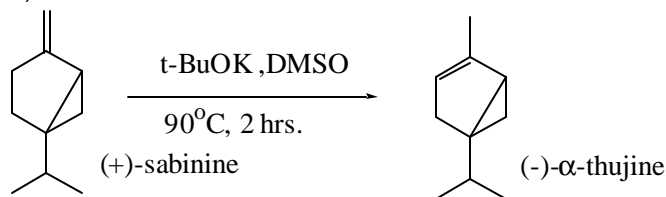

Isomerization of a mixture consisting of 17.4% 1-methylcyclopropene and 81.3% methylenecyclopropane with potassium t-butoxide and t-butanol in DMSO produces a 98% pure methylenecyclopropane (4262):

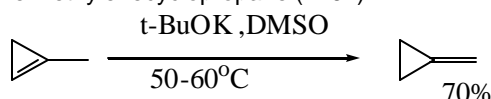

5. Racemization

In the racemization of saturated compounds by exchange of hydrogen at an asymmetric carbon, the rate of racemization correlates well with the acidity function of the reaction system containing DMSO (944). Similarly, the base-catalyzed rate of hydrogen-deuterium exchange correlates well with the racemization rate (1501). In solvents of high dissociating power which are not proton donors, e.g. DMSO, the carbanion (obtained with potassium t-butoxide) is long enough lived to become symmetrically solvated, and electrophilic substitution gives a racemic product (1161).

A variety of active functional groups can be attached to the saturated asymmetric carbon atom.

a) Alcohols

When optically pure tertiary alcohols with an asymmetric carbon atom are treated with a strong base in DMSO, the predominant steric course is racemization (1162)(2589).

b) Alkyl halides

The reduction of optically active tertiary alkyl halides with sodium borohydride in DMSO proceeds with racemization presumably via an elimination mechanism (3519):

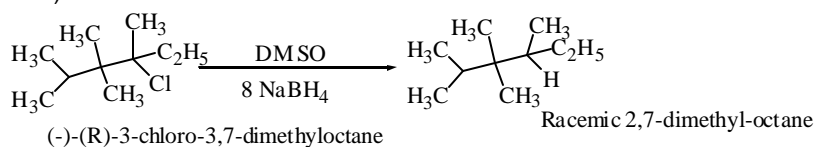

c) Amides, amino acids

D- α -Acetamide- α -vanillylpropionitrile is racemized using sodium cyanide as the base and DMSO as the solvent to give 96-97% pure DL- α -acetamido- α -vanillylpropionitrile (7772)(7984):

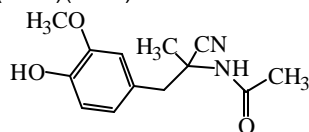

Optically active N-acylamino acids are racemized nearly quantitatively by heating with DMSO (8418).

d) Esters

The racemization and solvolysis of (+)-methyl 1-cyano-2,2-diphenyl-cyclopropane carboxylate has been studied in DMSO and six other solvents. In DMSO, racemization is the dominant reaction (6287).

e) Ethers

Potassium t-butylmercaptide in DMSO is a weaker kinetic base system than potassium t-butoxide in DMSO or than dimethyl sodium in DMSO in the racemization of optically pure (-)-1-methoxyphenylethane (496):

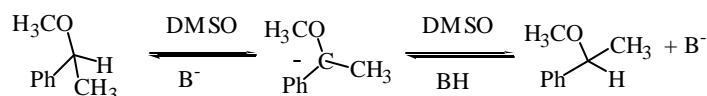

Rate constants for racemization of (-)-4-biphenyl-methoxyphenylmethane in methanol-0-d-DMSO-d₆ catalyzed by potassium methoxide have been measured (2007).

f) Hydrocarbons

The results of H-D exchange and racemization of (-)-9-deuterio-9-methyl-2-trimethylammonium fluorene iodide in t-butanol-DMSO catalyzed by tripropylamine are reported. Exchange (69%) and racemization (69%) take place (5339):

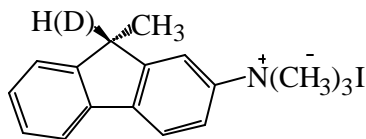

D-tetramisole or its 1-tetramisole enantiomer is racemized in DMSO solution in the presence of a catalytically effective amount of potassium hydroxide (10315):

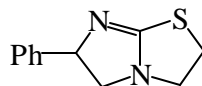

g) Nitriles

Racemization of 2-methyl-3-phenylpropionitrile in DMSO can proceed 1,000,000 times faster than in tert-butanol in the presence of the same base (434)(944).

The mechanism of base-catalyzed racemization of α -acetamidonitriles bearing no enolizable α -hydrogen has been studied in DMSO and found to proceed via elimination and readdition of the elements of HCN (2013).

The base catalyzed racemization of 2,2-diphenylcyclopropyl nitrile (1) has been studied in solvents containing various amounts of DMSO. With sodium methoxide as the base and nitrile 1 as a substrate, the rate for racemization in 1.5 mole % methanol-98.5 mol % DMSO is 3.6×10^8 times that observed in methanol (7282):

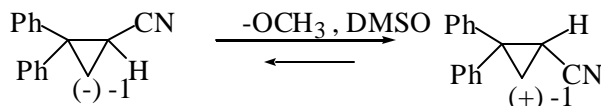

h) Sulfones

When the 2,2-dimethyl-1-phenylsulfonylcyclopropane is heated in DMSO for 6 hours at 175 °C the material is 88% racemized (2035):

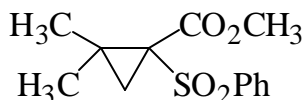

C. OTHER REACTIONS IN DMSO ADDITION REACTIONS

These are additions of nucleophilic compounds to carbon-carbon double bonds, carbon-carbon triple bonds, carbon-nitrogen triple bonds and others.

In a number of cases the use of DMSO improves the rate of addition of nucleophiles to olefins, such as acrylonitrile. The rate of addition of the glycine anion to acrylonitrile in an aqueous buffer is increased 200-fold by adding an equal amount of DMSO to the buffer (1233). Similarly, the cyanoethylation of methanol using potassium methoxide catalysis in methanol-DMSO occurs at a rate greater than in several other aprotic solvents. The order of effectiveness of the solvents for this reaction is also the order of their hydrogen bonding strength (1591).

a) Additions to acetylenes (carbon-carbon triple bonds)

The DMSO anion (dimethyl sulfide) adds to diphenyl acetylene to give a 95% yield of a cis-trans mixture of the expected unsaturated sulfoxide (203):

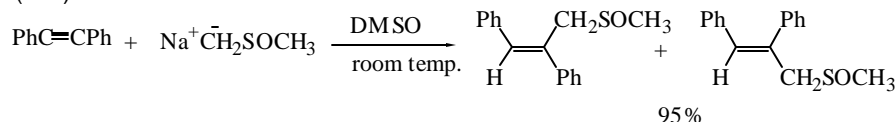

When the addition is conducted at 40 °C, the reaction consumes 2 moles of the DMSO anion with elimination of two methane sulfonate groups to give 2,3-diphenyl-1,3-butadiene (203):

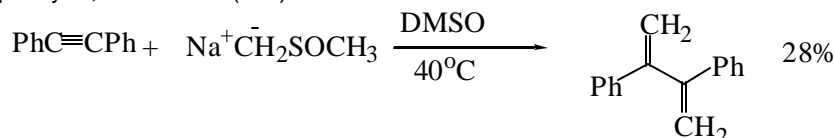

Ethyl phenylpropiolate reacts readily with dimethylsulfonium methylide to give 91 % of a stable ylide (217):

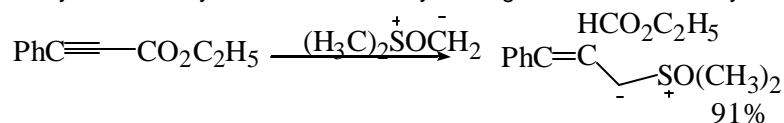

The addition of alkoxides to triple bonds in DMSO has been examined in structures where the intramolecular addition can occur (600)(101)(429). The rapid rearrangement of the triple bond to the allenic compound seems to precede the cyclization (600):

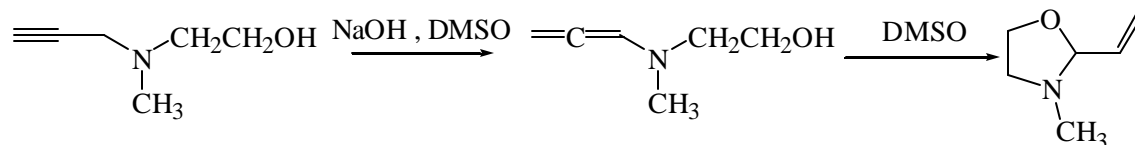

Dinitrophenylhydrazine reacts with dimethylacetylenedicarboxylate in DMSO-methanol to yield a 1:1 adduct which exists as an imine-emamine tautomer (3387):

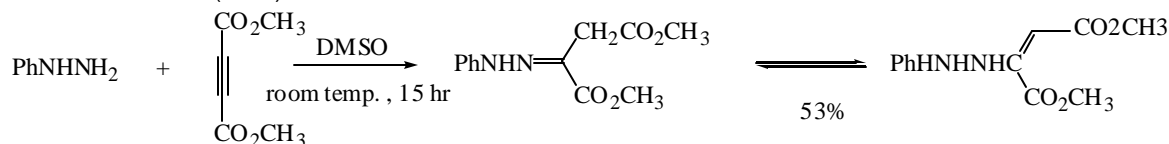

The reaction of alkynes with sodium azide in DMSO, followed by hydrolysis, affords 1,2,3-triazoles (3456):

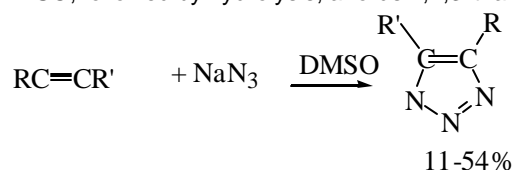

DMSO has been one of the solvents studied in the reaction of 1-propyl-sulfones and sulfoxides with ethylenimine. The greatest amount of trans product (cis addition) is formed in DMSO. This may be explained on the basis that DMSO can stabilize the zwitterionic intermediate best (3660):

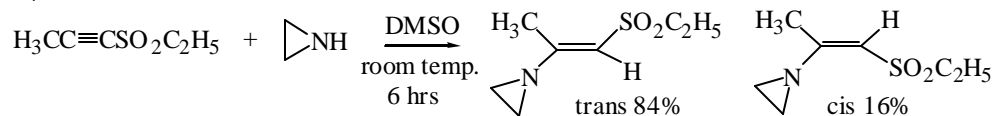

b) Additions to olefins (carbon-carbon double bonds)

Aliphatic conjugated dienes add the dimethyl sulfonium ion in DMSO to give sulfoxides. These unsaturated sulfoxides isomerize spontaneously and eliminate methanesulfonate upon continued warming in the strongly basic medium to produce the overall effect of methylation (411):

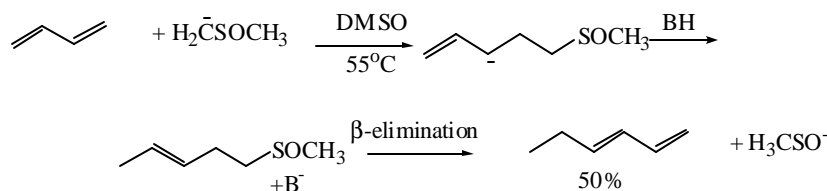

Although the yields of the aliphatic dienes are 50% or less, the yields using polynuclear aromatic compounds or some heterocyclic compounds, such as quinoline, are high (202):

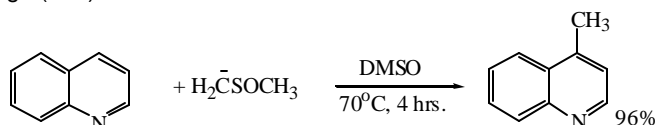

The dimsyl ion also adds to aryl conjugated olefins, such as styrene or 1,1-diphenylethylene, in DMSO to give the corresponding methyl 3-arylpropyl sulfoxides in almost quantitative yield (423):

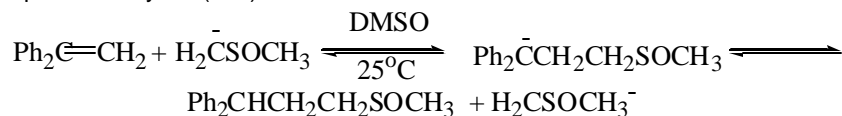

One stage sequential double methylation of the C=C bonds in stilbene, 2-methylstilbene and 4,4'-dimethoxystilbene with the dimsyl ion in DMSO leads to methyl diarylbutyl sulfoxides (7234):

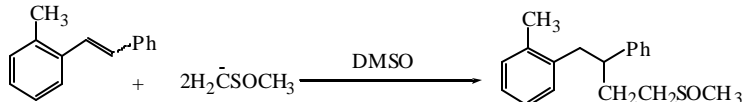

Kinetic rate measurements of the alkoxide catalyzed addition of methanol and ethanol to methyl esters of acrylic and methacrylic acid have been investigated in the mixed solvent alcohol-DMSO (3249).

1-Alkenecarbonitriles react with aromatic or heteroaromatic aldehydes in DMSO under the catalytic influence of cyanide ions to give α -oxonitriles (6172)(7582):

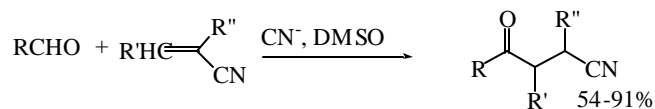

Alkyl esters of α , β - and β , γ -unsaturated carboxylic acids can be carboxylated at the α - or β -position using sodium phenoxide in DMSO (3506):

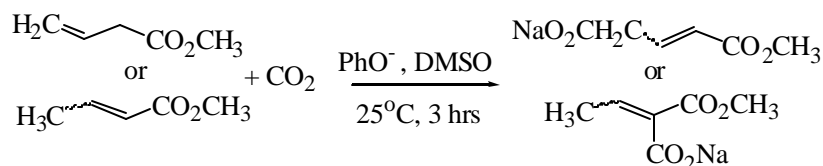

Sodium azide adds to α , β -unsaturated nitro compounds in DMSO to form 1,2,3-triazoles (4452):

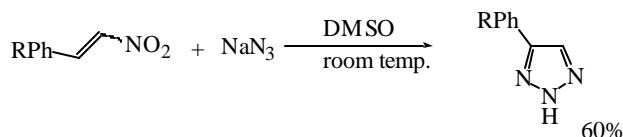

Phenacyl bromide and its derivatives in the presence of zinc or a zinc-copper couple undergo anti-Markownikow additions to terminal olefins (6627):

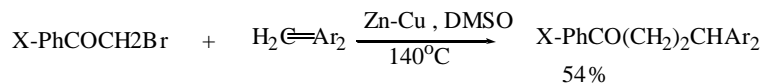

Phenacyl bromide in DMSO in the presence of the zinc-copper couple also adds to conjugated enynes and dienes (7536).

When olefins are treated with N-bromosuccinimide in DMSO containing a small quantity of water, the corresponding bromohydrins can be obtained after a short reaction time in high yields (705)(4026)(4817):

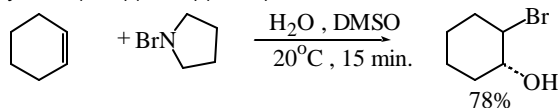

A variety of alkylaromatic compounds undergo nucleophilic addition to conjugated olefins (3384). Particularly when the reaction is performed in dipolar aprotic solvents, using potassium t-butoxide as a catalyst. The effectiveness of the solvents decreases in the following order. DMSO, HMPA, N-methyl-2-pyrrolidone, DMF, sulfolane, tetramethylurea (4339).

c) Additions to nitriles (carbon-nitrogen triple bond)

The reaction of sodium azide with nitriles, such as benzonitrile, occurs readily in DMSO to give 5-phenyl tetrazole (550):

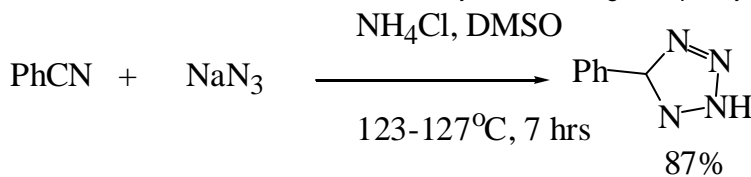

The reaction of anthranilonitrile with sodium hydride in DMSO yields 4-amino-2-(2-aminophenyl)quinazoline (8576):

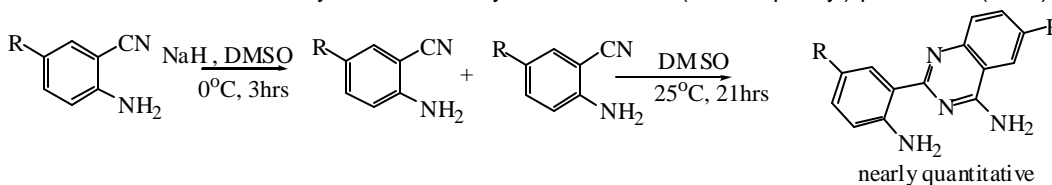

R = H or Br

Phthalodinitriles react with dicyandiamide in DMSO in the presence of basic compounds, such as potassium hydroxide, to produce phthalo-bis-guanamines (8008):

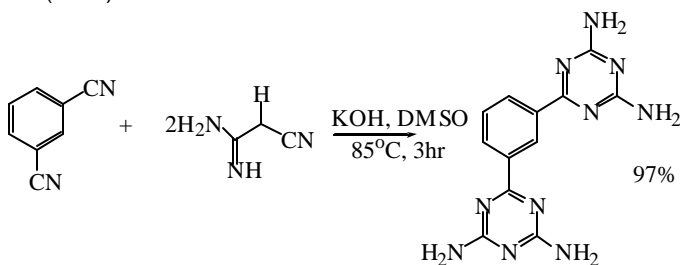

d) Additions to isocyanates

The reactions of organic isocyanates and diisocyanates are catalyzed by DMSO, and they run at good rates in this solvent (392)(312)(1360). Thus, diisocyanates react in DMSO with active hydrogen compounds such as dihydrazides (450), polyols (449), or even with the hydroxyl groups of carbohydrates (cellulose) (443). In the last instance, DMSO is also used as an effective swelling agent for cellulosic rayon fibers.

Diisocyanates, such as bis(4-isocyanatophenyl)methane or 2,2-bis(4-isocyanatophenyl)propane, react with ethylene glycol in DMSO. Polyurethane filaments can then be spun from the reaction mixture (1880):

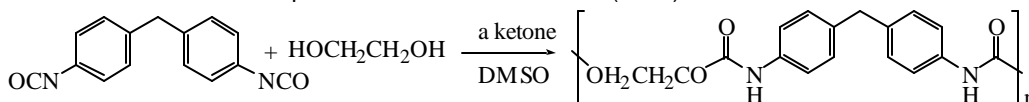

Dry DMSO is inert to alkyl or aryl isocyanates but it does react with isocyanates having electron withdrawing groups such as acyl (714) or sulfonyl (308)(391).

A number of synthetic polymers containing sugar residues, such as D-cellobiose (10116)(10439) and a , a -trehalose (10123), have been prepared by direct addition polymerization of the carbohydrate with diisocyanates, such as 4,4'-methylenebis(phenylisocyanate) in DMSO.

CONDENSATION REACTIONS

These are mostly specific reactions (e.g. aldol condensation, Mannich reaction) in which two or more molecules combine, usually with the separation of water or some other simple molecule.

Most of the ordinary reactions of carbonyl compounds can be accomplished in DMSO. Good results are often obtained either because of the greater solubility of generally insoluble reactants or because of enhanced reactivity of nucleophiles.

a) Aldol-type condensations

Alkyl aryl ketones react easily and at a high rate with paraformaldehyde in DMSO in the presence of base to yield hydroxymethyl compounds. The high reaction rates may be attributed to the high reactivity of the anionic catalyst in the DMSO medium (1099). Thus, 1-indanone and formaldehyde react rapidly in DMSO to yield 2,2-bis(hydroxymethyl)-1-indanone:

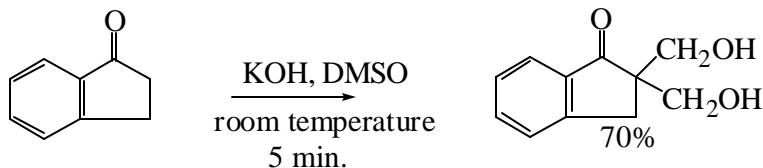

Fluorene and o- and p-nitrotoluene react similarly with paraformaldehyde in an aldol like addition in DMSO under the influence of a strong base to give hydroxymethyl compounds (1100).

Racemic 2-(o-formylphenoxy)propiophenone can be prepared in 79% yield from equivalent amounts of a sodium salt of salicylaldehyde and 2-bromopropiophenone in DMSO. When the reaction product is kept in DMSO in the presence of quinine, two optically active diastereomeric ketols result (5613):

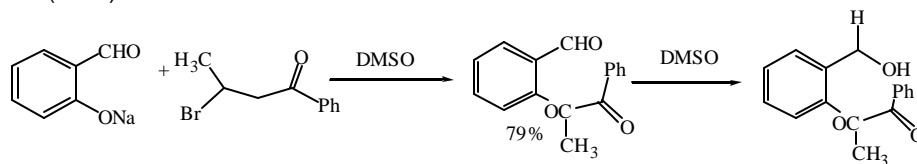

The reaction of 1-hydroxy-2,2,5-trimethyl-3,4-hexadione with paraformaldehyde in DMSO in the presence of potassium hydroxide gives 1,6-dihydroxy-2,2,5,5-tetramethyl-3,4-hexadione (6028):

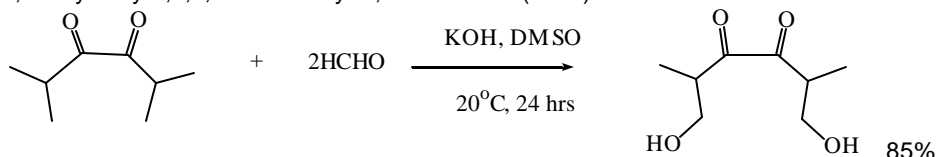

2-Carbomethoxycyclohexanone condenses with 3-pent-2-one in DMSO in the presence of sodium methoxide to give methyl 4-methyl-1(9)-octal-2-one-1O-carboxylate (4048):

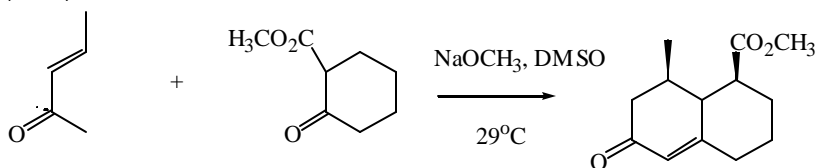

The reaction of pentafluoroacetophenone with methyl benzoate in the presence of sodium hydride in DMSO is the best way to the diketone (3376):

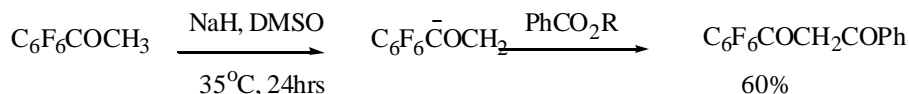

b) Ester condensation

The esters of carboxylic acids react with the dimethyl ion in DMSO to yield β -keto sulfoxides (639)(1651):

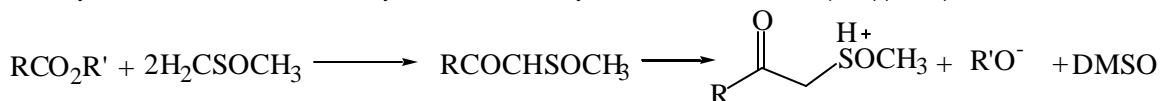

This condensation reaction has found a fairly wide application in the synthesis of useful intermediates. Thus, a number of benzoic acid esters can be reacted with the dimethyl ion in DMSO to give the corresponding β -keto sulfoxides (9150):

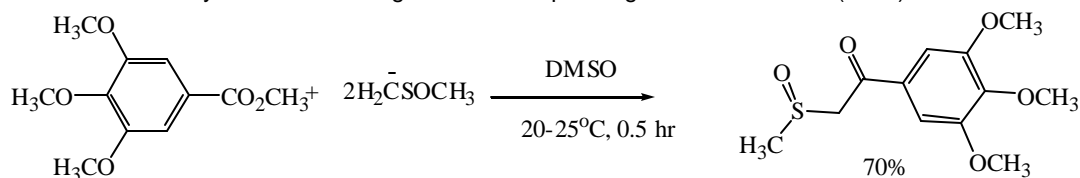

Ethyl salicylate reacts with 3.2 equivalents of dimethyl ion to give the β -keto sulfoxides (9196):

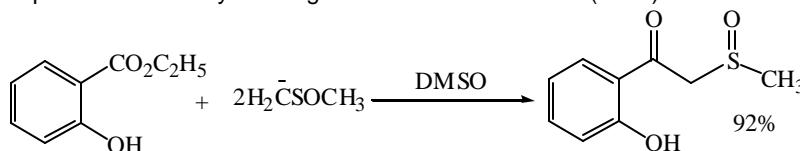

A number of β-keto sulfoxides have been prepared by condensing the dimethyl ion with substituted phenyl or naphthyl esters (9249)(9402). Thus, ethyl 1-hydroxy-2-naphthoate reacts with the dimethyl ion to give 3'-hydroxy-2-(methylsulfinyl)-2'-acetonaphthone (9244):

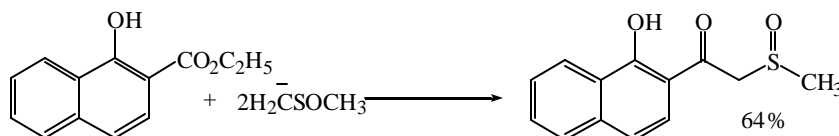

Ethyl isovalerate gives methyl sulfinyl methyl isobutyl ketone (9825):

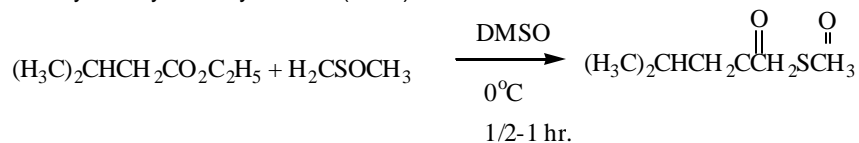

The preparation and synthetic applications of β -keto-sulfoxides have been reviewed (4820)(8529).

Symmetrical β -diketones are readily prepared by reacting methyl esters with methyl ketones in DMSO with sodium hydride as the base (193):

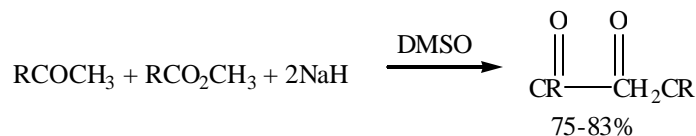

The yield is increased from 36% to 83% by using sodium hydride in DMSO instead of sodium methoxide in toluene.

In the presence of zinc-DMSO, 2,2,2-trichloroethyl esters of α -substituted β -keto acids react stereospecifically at the α -carbon to the ester carbonyl with aldehydes to give aldols in good yields (8833):

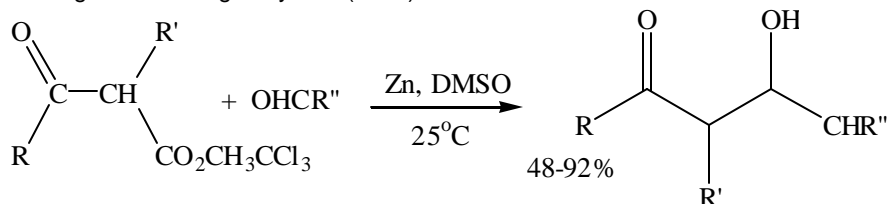

Cyclohexanediones-1,3 are prepared in good selectivity by reacting an α, β -unsaturated carboxylic acid ester with a ketone in the presence of a strong base in DMSO (8717):

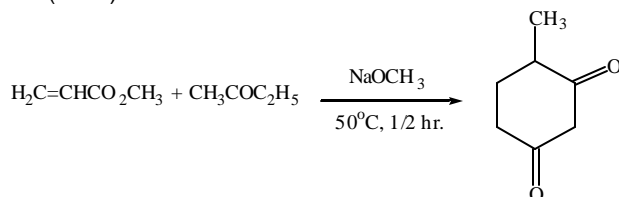

c) Dieckmann condensation-cyclization

The Dieckmann condensation of dimethyl-1-methylcyclohexane 1,2-diacetate with sodium hydride in DMSO furnishes a crystalline keto ester (6593):

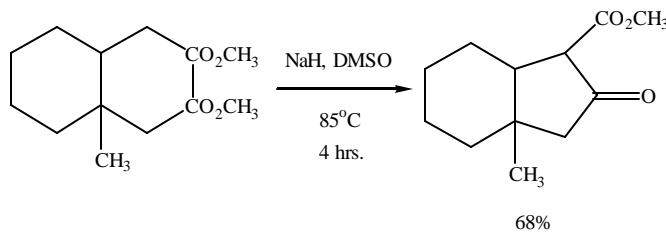

Reaction of diethyl γ -ketopimelate with an excess of methylenetriphenylphosphorane in DMSO provides for the introduction of an exocyclic methylene group and subsequent Dieckmann condensation to the carbethoxycyclohexanone (6648):

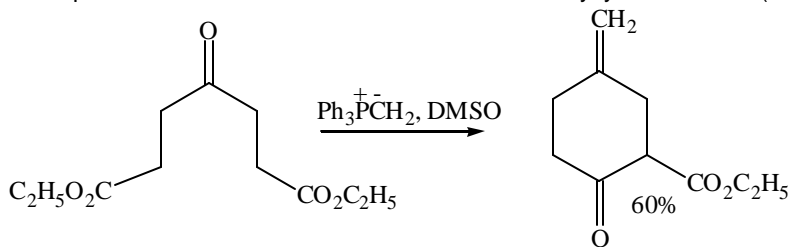

d) Mannich reaction

A β -keto carboxylic acid reacts with formaldehyde-piperidine hydrochloride in DMSO to give the corresponding α -methylene ketone in excellent yield (6463)(8888):

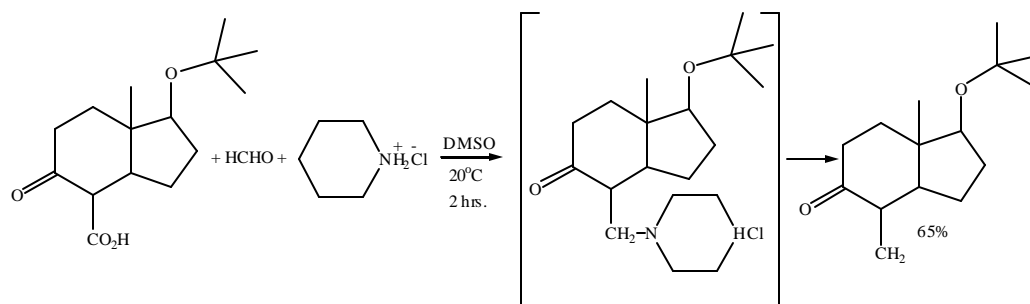

The first step in the reaction is probably decarboxylation. The Mannich reaction product is most likely formed, but it loses piperidine hydrochloride in the highly polar reaction medium.

The "Mannich reagent", dimethyl (methylene)ammonium iodide, reacts with enol borinates in DMSO-THF to provide excellent yields of β -dimethylamino ketones (6671):

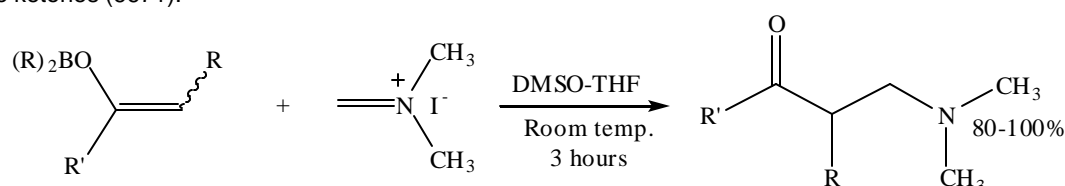

e) Michael condensation

The reaction of methyl α -bromo- β -methoxypropionate (I) with sodium nitrite in DMSO in the presence of phloroglucinol gives dimethyl α -methoxymethyl- α , α' -dinitrogluturate (IV), which is formed from methyl α -nitro- β -methoxypropionate (II) and methyl α -nitroacrylate (III) by Michael addition (664):

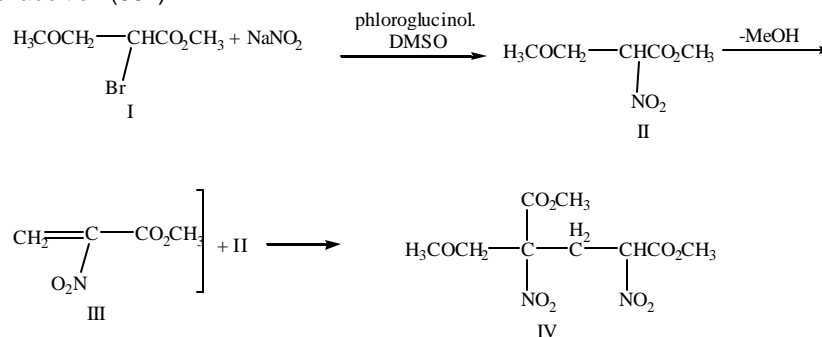

Double Michael reaction of 3-methyl-4-methylene-cyclohex-2-enone with dimethyl 3-oxoglutarate in DMSO in the presence of potassium fluoride as a catalyst gives a mixture of the stereomeric diketodiester (9746):

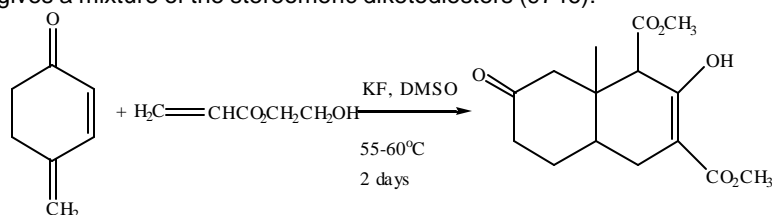

Michael addition of carbazole to 2-hydroxyethyl acrylate in DMSO in the presence of 1,8-diazobicyclo[5.4.0]-7undecene (DBU) takes place under mild conditions (10091):

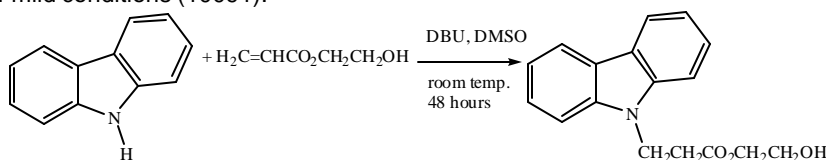

Michael-type polyaddition of dithiols to divinylsulfoxide in DMSO leads to the formation of poly(sulfinylethylene-thioalkene (or arylene)thioethylene)s (10443):

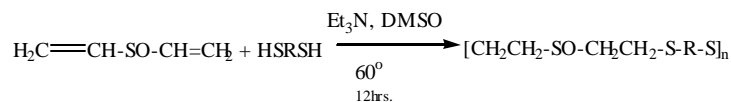

f) Reformatsky reaction

Bromonitriles, when treated with zinc in DMSO-THF, yield an intermediate organozinc compound. β -Hydroxynitriles are then prepared from this intermediate and aliphatic aldehydes and ketones (4767):

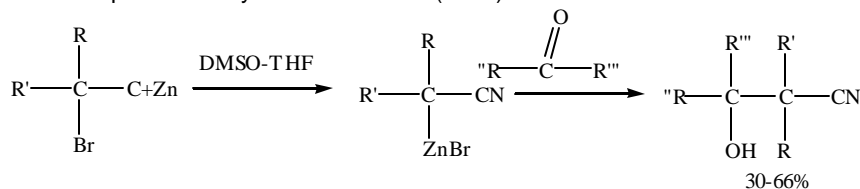

g) Thorpe-Ziegler condensation

1,4-Dinitriles, which can be prepared from dihalides or ditosylates and sodium cyanide in DMSO, can be cyclized directly to β -enamino nitriles in very high yields (477)(6163):

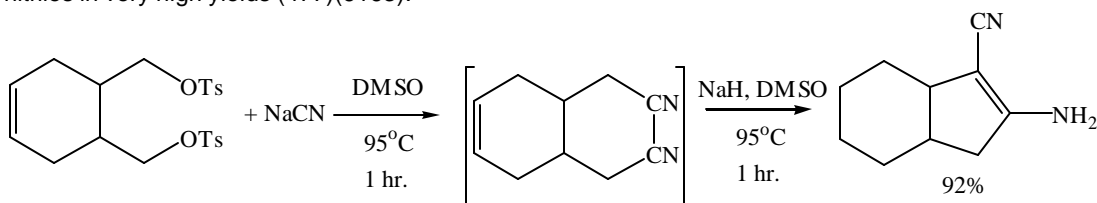

The cyclization of 1,2-di-(cyanomethoxy) benzene with dimethyl ion (sodamide + DMSO) in DMSO produces 3-amino-4-cyano-2H-1,5-benzodioxepin (8690)(9145):

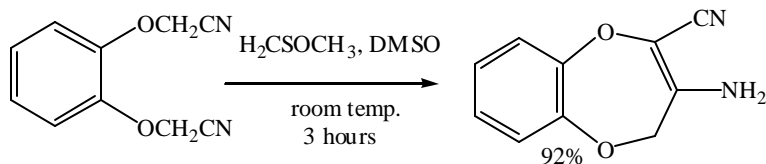

h) Ullmann-type condensations

Iodoalkanes react with aryl iodides in DMSO in the presence of copper to give arylalkanes (5185) (7293):

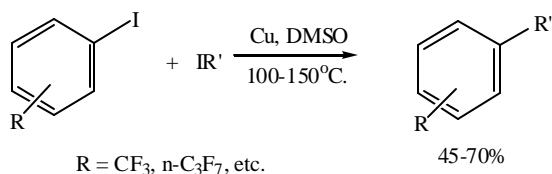

i) Wittig reaction

The reaction of a tertiary phosphine (usually triphenylphosphine) with an alkyl halide to yield a phosphonium salt can be done in DMSO (4669). DMSO also seems to be a good solvent for these salts. In these phosphonium salts, the α -C-H bonds are sufficiently acidic (5551) for the hydrogen to be removed by a strong base in DMSO, e.g. an organolithium compound (4110), sodium hydride or the dimethyl ion (8360), to produce a phosphorus ylide (a phosphorane), the so-called Wittig reagent. Subsequent reactions of these ylides with aldehydes, ketones or hemiacetals in DMSO offer a useful synthesis for olefins. The overall reaction can be written as follows (49)(240)(5551):

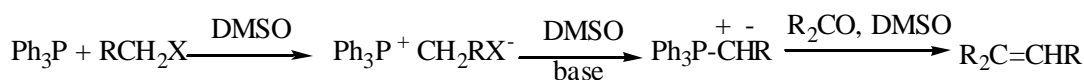

As mentioned above, the Wittig reaction converts carbonyl compounds to olefins. Thus, the reaction of formaldehyde and the phosphorane derived from 1,5-bis(triphenylphosphoniomethyl)naphthalene dibromide in DMSO gives 1,5-divinylnaphthalene (7641):

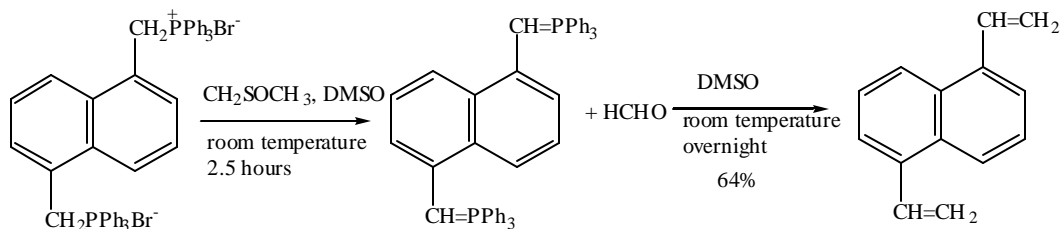

Ketones react with phosphoranes in a way similar to aldehydes. Verbinone with methylenetriphosphorane in DMSO yields methylenedihydroterpine (7476):

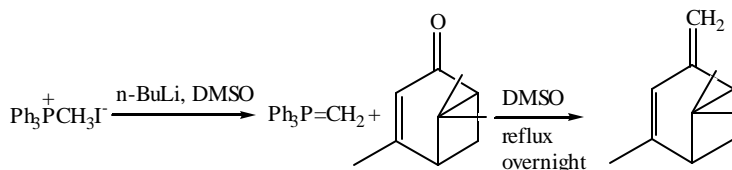

Lactols (hemiacetals) can also be reacted with a Wittig reagent (7691). Treatment of a lactol with a Wittig reagent derived from 5-triphenylphosphoalverate ion in DMSO gives the corresponding hydroxy acid (7729):

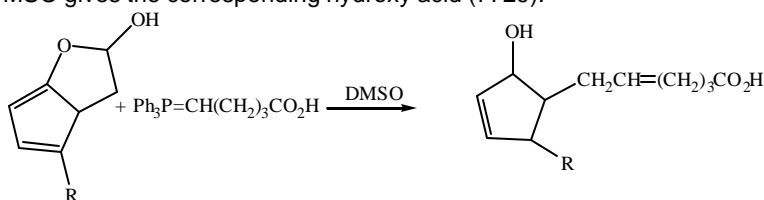

It has also been found that aromatic and aliphatic esters can be directly converted to the corresponding isopropenyl compounds by reaction with methylenetriphenylphosphorane in DMSO (10078):

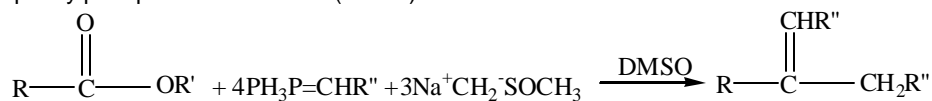

OXIDATION REACTIONS

These are reactions in which oxygen combines chemically with another substance or reactions in which electrons are transferred from one substance to another. DMSO in these reactions, with a few exceptions, is a solvent and not a reactant, i.e. it gets neither reduced nor oxidized.

Many different reactions using oxygen have been conducted in DMSO, such as autoxidation (also chemiluminescence), dehydrogenation, hypohalite reactions, lead tetraacetate oxidation, silver compound oxidations, superoxide and peroxide oxidations and others not discussed here (e.g. electrooxidation, periodic acid oxidations, manganese dioxide oxidations, sulfur dioxide oxidations).

a) Autoxidation

The base-catalyzed oxidation of a number of compounds by oxygen in DMSO-t-butanol mixtures has been studied extensively. Formation of the carbanion of the substrate usually precedes the oxidation. The rate of carbanion formation and oxidation increases as the DMSO content is increased (728).

In the solution DMSO-t-butanol-potassium t-butoxide, a number of hydrocarbons can be oxidized easily. Thus, triphenylmethane reacts with oxygen in the above system to form triphenylcarbinol (479):

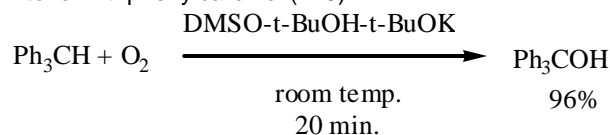

Aniline under the above conditions gives azobenzene (469):

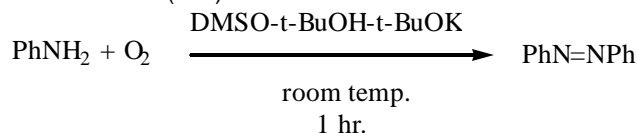

Ketones in DMSO-potassium t-butoxide are oxidized to semidiones (1787):

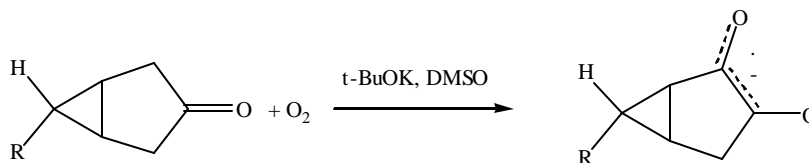

Some ketones can also be oxidized to the carboxy compounds (9707).

When nitrotoluenes are oxidized in DMSO-potassium t-butoxide, dimers or acidic products can be formed (568). Thus, the autoxidation of o- and p-nitrotoluene in DMSO under basic conditions result in the formation of 1,2-di(nitrophenyl)ethanol, presumably via the corresponding nitrobenzaldehydes (4812):



The above dimers can be further oxidized to ketones, or dehydrated to nitrostilbenes (4812).

The autoxidation of 1- and 3-arylpropenes has been induced with the DMSO-t-butanol system containing potassium t-butoxide. The autoxidation of safrole gives piperonylic acid. Without DMSO, no oxidation takes place (1140):

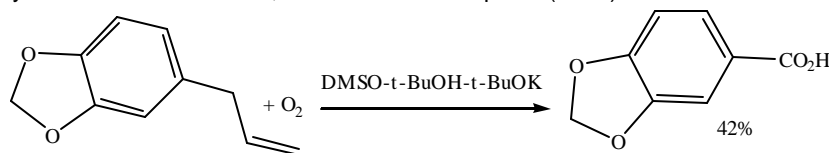

In the presence of alkali metal hydroxides, it is possible to oxidize various substituted methanes, such as a, a-diphenyl-2-pyridenemethane, to the corresponding alcohols using air or oxygen and DMSO as the sole solvent (6971):

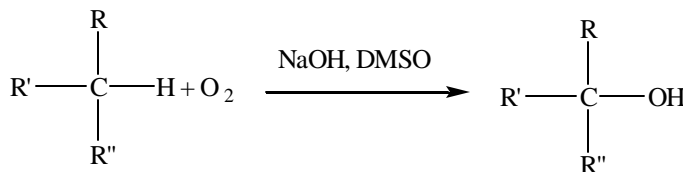

1,2,5,6-Dibenzanthracene and several other aromatic hydrocarbons are oxidized to the corresponding quinone derivatives in basic DMSO (5587).

Autoxidation of 1-methyl-2-isopropyl-5-nitroimidazole in DMSO with air or oxygen in the presence of a base gives 2-(2-hydroxy-2-propyl)-1-methyl-5-nitroimidazole (8867):

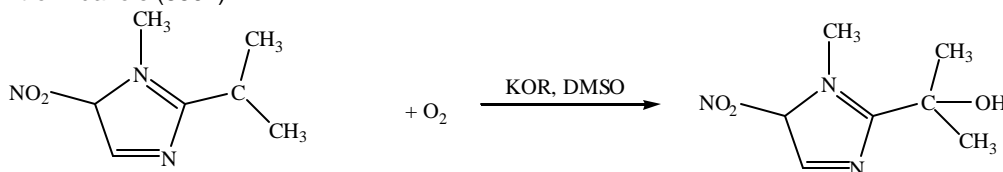

Base catalyzed autoxidation of ethyl 2-cyano 3,3-disubstituted carboxylates in DMSO gives good yields of the 2-oxo esters (3662):

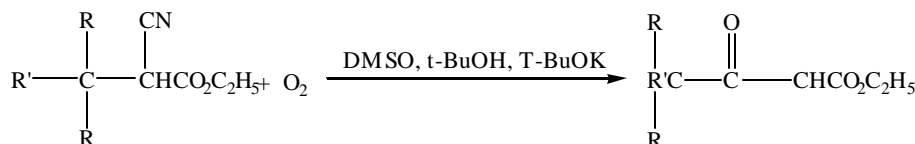

The system cobalt (II) and/or (III) acetylacetonate-t-butyl hydroperoxide has been used to initiate autoxidation of polyvinyl alcohol in DMSO (8043).

9,10-Dihydroanthracene can be oxidized to anthraquinone with oxygen in DMSO containing an inorganic base, such as sodium hydroxide (2940).

b) Chemiluminescence

Chemiluminescence reactions are very similar to autoxidation. Both these reactions require oxygen and the presence of a strong base. Chemiluminescence reactions can be classified as special autoxidation reactions that produce light emissions. As the basicity of alkoxides and hydroxides is enormously enhanced in DMSO over the value of hydroxylic solvents, it has also been observed with chemiluminescence reactions that the emission periods have been increased and the light intensities enhanced in DMSO containing a base (1025).

A bright green light is observed on the treatment of a solution of 2,3-dimethylindole and its hydroperoxide in DMSO with a base, e.g. potassium t-butoxide or granular potassium hydroxide (2140)(2218):

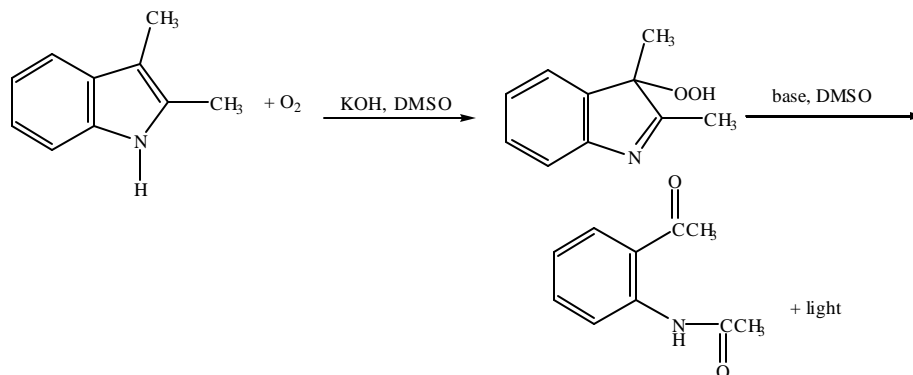

When DMSO, luminol, water and caustic solution are shaken in the presence of oxygen from air, an oxidation reaction produces considerable bright blue-green light. The reaction sequence can be represented as follows (3241):

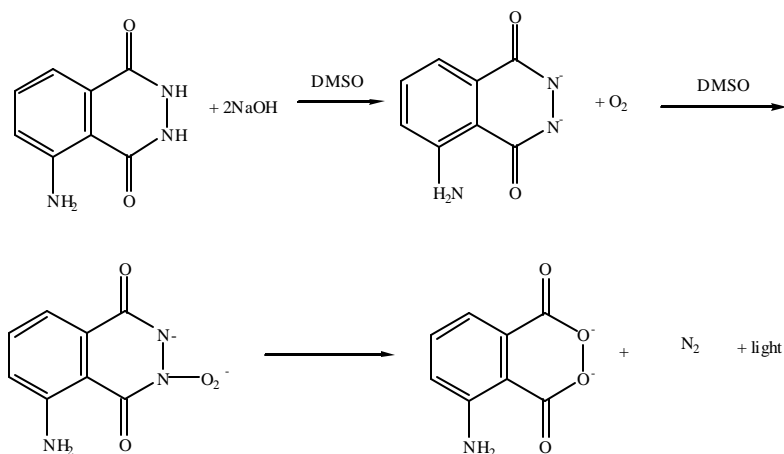

Some derivatives of luminol, containing methoxyl groups, are more efficient in chemiluminescence in DMSO solution than luminol itself (1668).

The reaction of potassium cyanide with N-methylacridinium chloride in 90% DMSO-10% water produces N-methyl-90-cyanoacridan. With excess cyanide, the red N-methyl-9-cyanoacridanide ion is produced which, in the presence of oxygen, produces N-methylacridone and potassium cyanate with light emissions (3653):

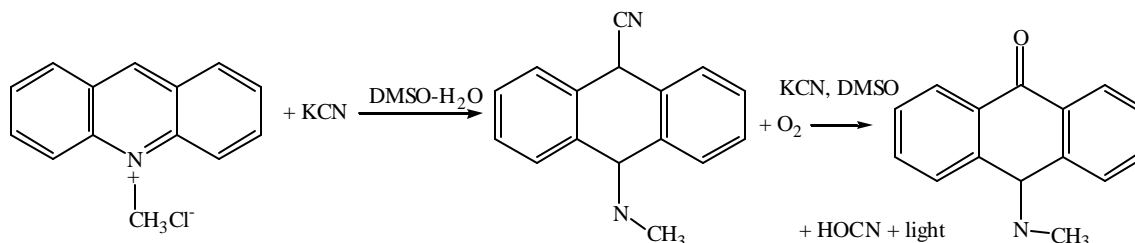

The chemiluminescence emission spectra of two efficient chemiluminescent linear hydrazides in DMSO with potassium t-butoxide and oxygen suggest that the corresponding acid anion is the light emitter (5116):

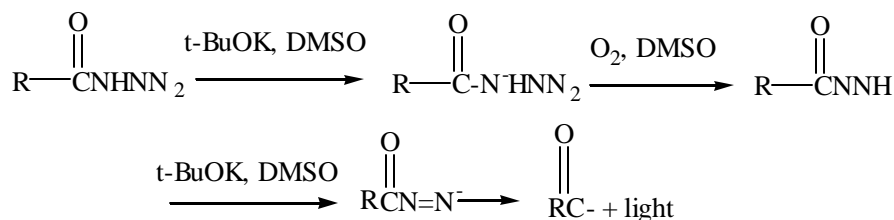

c) Other oxidations with oxygen

Carbonyl compounds can be manufactured by oxidation of olefins, such as ethylene, propylene, styrene, and cyclohexane, in water-DMSO mixture in the presence of a catalyst to give acetaldehyde, acetic acid, acetone, propanol, acetophenone and others (5800). DMSO can be used as a catalyst component in the oxidation of olefins, e.g. DMSO can be a coordinate in complexes such as $\text{Cu}(\text{ClO}_4)_2(\text{DMSO})_4$, or $\text{Fe}(\text{ClO}_4)_3(\text{DMSO})_4$, (9412).

3-Oxo- Δ^4 -(19)-norsteroids react with oxygen in DMSO to afford 1,3,5-(10)-oestratrien-6-ones (5912):

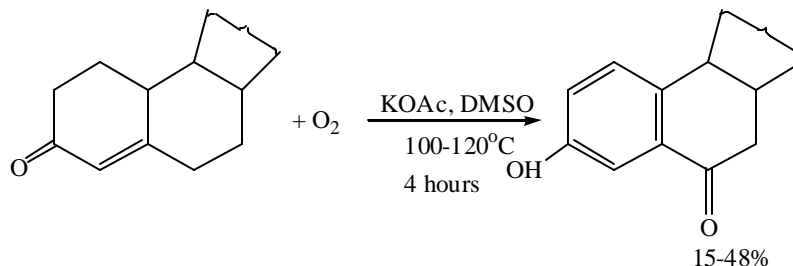

The liquid phase oxidation of *s*-butanol with oxygen under pressure has been examined in various solvents using vanadium pentoxide-molybdenum trioxide catalyst. While no reaction occurs in water, benzene, or chlorobenzene, the oxidation in DMSO at 125°C for 13 hours converts 10.8% of *s*-butanol to methyl ethyl ketone with a selectivity of 89% (9434).

Terpenes can be oxidized with dry air in DMSO. Thus, α -longipinene is oxidized at 125-135°C to longiverbone as the major product (9871), and *p*-mentha-1,4(8)- and -2,4(8)- dienes at 100°C give *p*-methylacetophenone (9874).

In neutral solution, benzyl alcohols can be oxidized by oxygen in the presence of ultraviolet light to give the corresponding aldehydes (737)(1118):

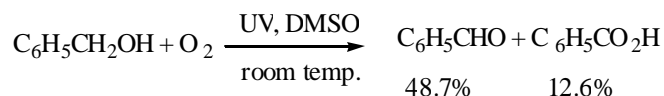

The oxidation of benzoin by cupric sulfate and oxygen in DMSO occurs to give a high yield of benzil (945):

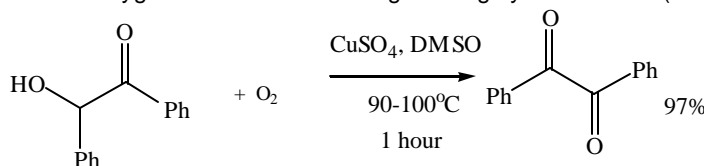

d) Dehydrogenation

In the dehydrogenation reaction, oxidation (i.e., the removal of hydrogen) can take place without the presence of oxygen.

Several platenoid metal catalysts in DMSO promote dehydration, disproportionation and dehydrogenation of diarylcarbinols (10422). The dehydrogenation can be the main reaction when DMSO is used as the solvent instead of α -methyl-naphthalene (8838):

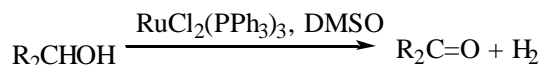

Dihydroarenes, e.g. 1,2-dihydronaphthalene, can be converted into the corresponding aromatic compounds, e.g. naphthalene, by deprotonation with potassium fencholate, followed by dehydration with fenchone (2-oxo-1,3,4-trimethylbicyclo [2.2.1]-heptane) (9707):

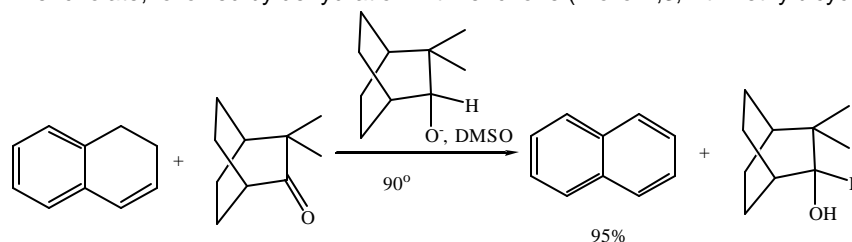

5,7,4'-Trimethoxyflavanone, when heated with DMSO in the presence of a catalytic amount of iodine and concentrated sulfuric acid, gives 5,7,4'-trimethoxyflavone in almost quantitative yield (10,000):

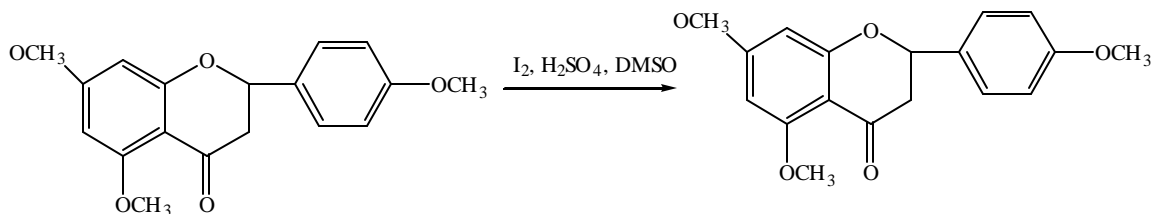

A solution of sodium dichromate and sulfuric acid in DMSO oxidizes primary alcohols to aldehydes and secondary alcohols to ketones. In these oxidations, DMSO acts as a solvent and not as a reactant (7609):

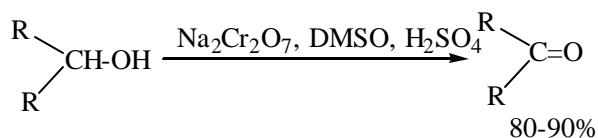

e) Hypohalite oxidations

Halogenations with sodium hypohalites of alkyl- or arylamides and isoureas in DMSO solution afford the corresponding alkyl-, aryl- or alkoxy-3-haloazirines in practical yields (843):

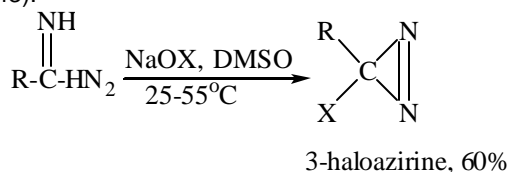

Oxidative cyclization of trifluoroacetamide with hypochlorite and chloride ion in aqueous DMSO gives the corresponding diazirine (8108):



f) Lead tetraacetate oxidations

Polysaccharides, such as dextran and amylose, can be oxidized by lead tetraacetate in DMSO if 15-20% of glacial acetic acid is added to prevent oxidation of the solvent. This oxidation proceeds at a rate which is several times faster than the periodate oxidation in aqueous solution. Polysaccharides oxidized by lead tetraacetate contain free aldehyde groups. Oxidation follows the normal glycol-cleavage pattern (615).

Oxidation of 1-amino-3,4,5,6-tetraphenyl-2-pyridone with lead tetraacetate in DMSO gives the corresponding 5,5-dimethyl-N-sulfoximide, indicating that DMSO is an efficient trap for N-nitrenes (4987):

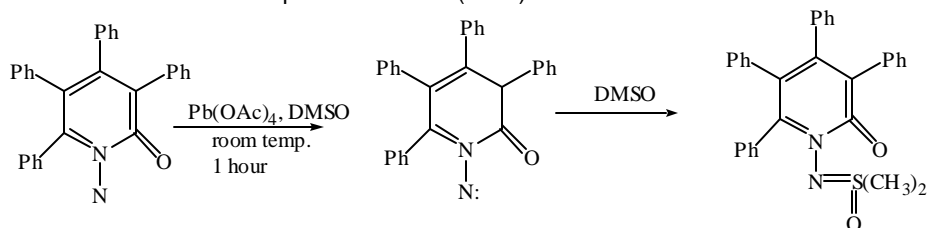

Similarly, lead tetraacetate oxidation of N-aminolactams in the presence of DMSO gives the sulfoximides in good yields (5846):

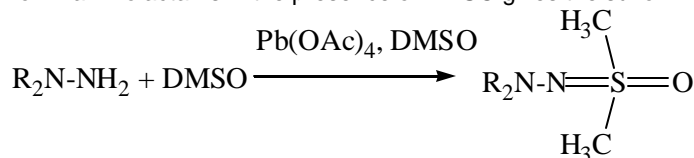

Oxidation of aminonaphth[2,3-b]azet-2(1 H)-one by lead tetraacetate in DMSO leads to 2-naphthoic acid (6243):

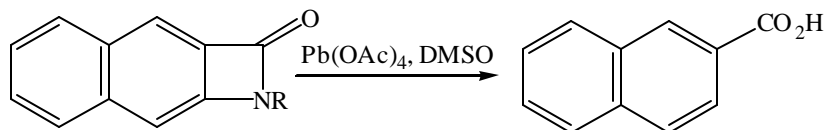

Treatment of a dicarboxylic acid (prepared from the Diels-Alder adduct of dimethyl-cyclobut-1-ene-1,2-dicarboxylate with butadiene) with lead tetraacetate in DMSO containing pyridine gives a product which is mainly bicyclo [4,1,0]octa-1(6),3-diene, with a small amount of benzocyclobutene (7533):

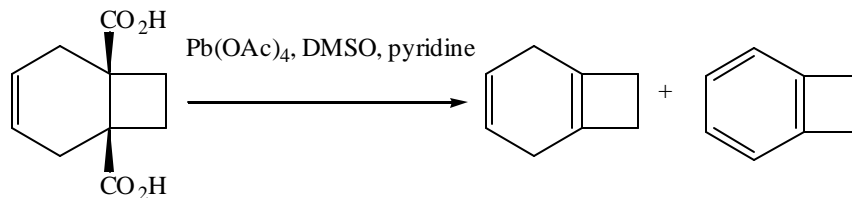

g) Silver compound oxidations

A number of alcohols, e.g. methanol, ethanol, n-propanol, isoborneol, can be oxidized by argentic picolinate to yield the corresponding aldehydes or ketones, i.e., formaldehyde, acetaldehyde, propionaldehyde, camphor. The rate of reaction is influenced by the solvent, and the use of DMSO leads to a more rapid reaction (2915):

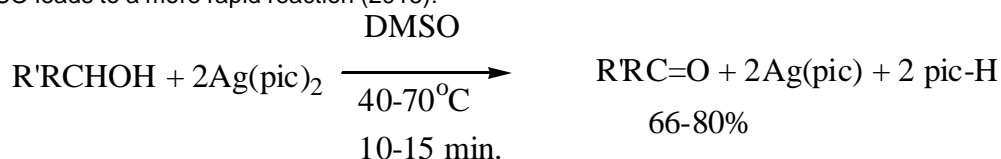

Oxidation of menaquinol-1 dimethyl ether with silver picolinate in DMSO gives the desired alcohol (4653):

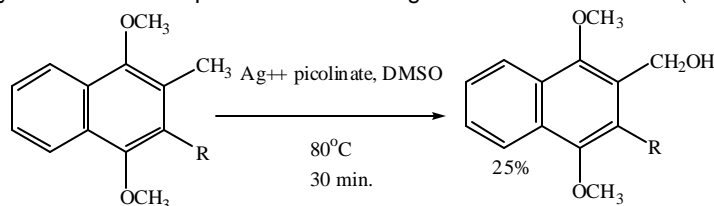

Reaction of 1,2-diphenyl-2-[(phenyl)methylamino]vinyl chloride with silver (II) oxide in DMSO gives benzil (5843):

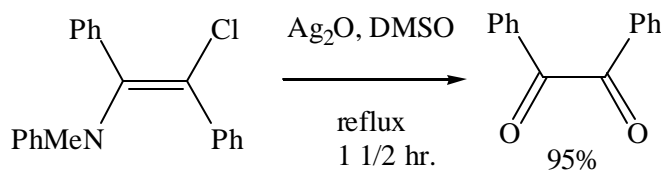

In boiling nitromethane with silver tetrafluoroborate, the yield of benzil is only 60% (5843).

Bromoalkyl formates are easily converted to protected secondary hydroxyaldehydes by treatment with silver tetrafluoroborate in DMSO in the presence of triethylamine (7507):

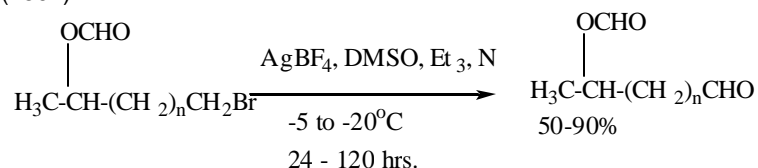

The use of silver nitrate in DMSO on a 3-chloro-7-hydroxy-17-oxo-androstane accomplishes two purposes. It oxidizes the 7-hydroxy group to the 7-oxo group, and it dehydrohalogenates the steroid (8340):

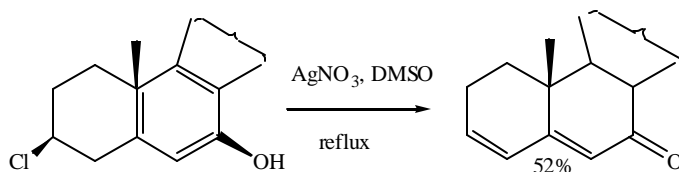

17 α -Ethyne-17 β -hydroxysteroids are converted quantitatively to the corresponding 17-ketones by treatment with excess silver carbonate or silver oxide in DMSO (7460):

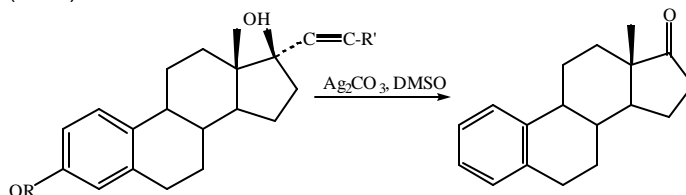

Dimethyl esters of monoalkylated malonic acids and β -keto esters are easily oxidatively dimerized by silver oxide in DMSO (8830), e.g.:

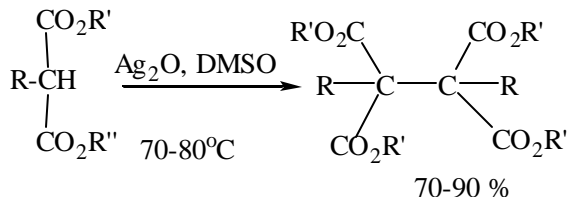

h) Superoxide and peroxide oxidations

Secondary amines are instantaneously oxidized to dialkyl nitroxides by potassium superoxide in DMSO (6293):

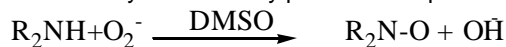

Alcohols are the major end products resulting from the reaction of alkyl halides and tosylates with an excess of potassium superoxide in DMSO in a rapid process in which the C-O bond-forming step proceeds with inversion of configuration (8030):

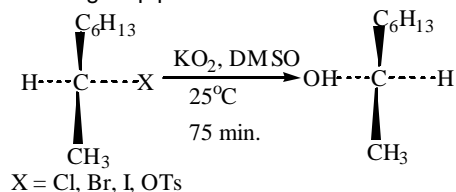

With 1-bromooctane, the yield of 1-octanol is 63%.

Phenolic compounds are prepared by oxidation of aromatic hydrocarbons with organic hydroperoxides in the presence of boron oxide, meta- or orthoboric acid or their lower alkyl esters, and DMSO. Thus, DMSO is added to a mixture of m-xylene, tetralin hydroperoxide and boron oxide to give 38:62 ratio of 2,6- and 2,4-xyleneol, dihydronaphthalene and tetralone (8658).

REDUCTION REACTIONS

These are reactions in which hydrogen is added or oxygen or a halogen is removed. DMSO can be either a solvent or a catalyst component.

Although DMSO can be either oxidized or reduced, it is comparatively stable toward both changes and hence can be used as a solvent for many oxidation-reduction reactions. In polarography studies using tetraethylammonium perchlorate electrolyte, the usable potentials range from +0.3 volts anode potential to -2.8 volts cathode potential (both relative to the standard calomel electrode) (553)(772). In general, the halfwave potentials for inorganic ions in DMSO are quite similar to those in aqueous solutions (553). However, a more negative cathode potential is usable in DMSO as shown by the observation of the magnesium wave at -2.20 volts. Lithium metal is inert toward DMSO (206). The electrodeposition of cerium cannot be accomplished in aqueous solution because the metal is too positive but it can be deposited from a DMSO solution of cerium chloride (1744). The transfer of electrons between molecules of redox systems sometimes occurs very readily in DMSO as observed for isotope exchange between ferrous and ferric perchlorates (1036)(923) and in

the base-catalyzed transfer of electrons between *R* unsaturated organic molecules and their dihydro derivatives (722).

1. Reduction of Alkyl Halides and Sulfonates

a) Reduction with sodium borohydride

the selective substitution of hydrogen for primary, secondary or, in certain cases, tertiary halogen (or sulfonate) in alkyl halides without reduction of other functional groups present in the molecule may be effected by reduction with sodium borohydride in DMSO (2980)(3248):

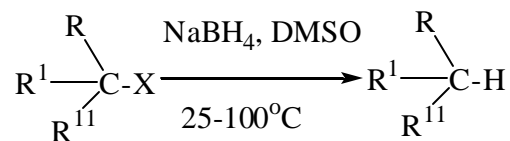

X=Cl, Br, I, tosylate

Sodium borohydride in DMSO is a convenient source of a nucleophilic hydride which may be used for the reductive displacement of primary and secondary alkyl halides, or sulfonate esters (e.g. tosylates). The mildness of borohydrides allows a number of chemoselective transformations without damage to groups (e.g. COOR, COOH, CN, NO₂) normally affected by harsher reagents such as lithium aluminum hydride (9783).

The reduction of optically active tertiary alkyl halides with sodium borohydride in DMSO proceeds with racemization, presumably via an elimination-addition mechanism (3519):

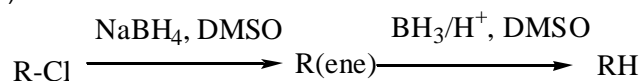

4-Nitro-2-chloromethyl-1-isopropylbenzene can be reduced with sodium borohydride in DMSO in good yield (4602):

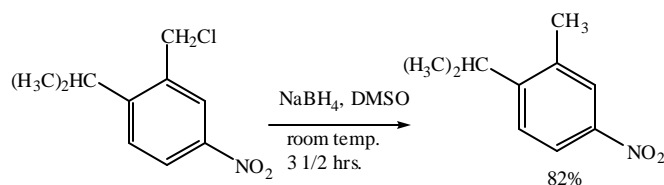

An iodo-tosylate can be reduced with sodium borohydride in DMSO to give one major product, a cyclopentadiene (6502):

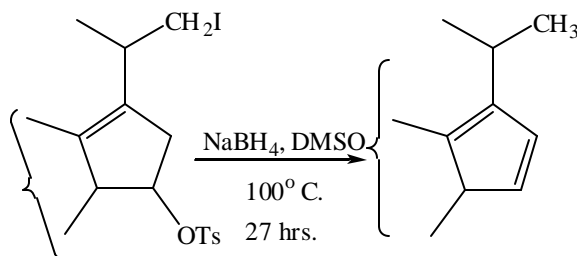

In the above case, both reduction of the iodide and elimination of the tosylate take place.

Sodium borohydride in DMSO selectively reduces 2-chloro-4-chloromethyl naphthalene to 1-chloro-4-methylnaphthalene (6785):

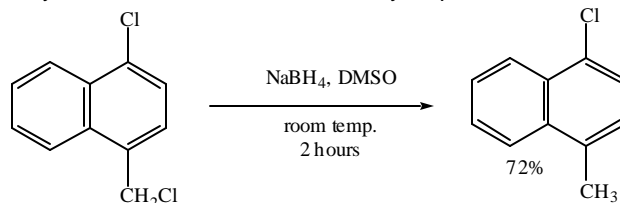

Sodium borohydride in DMSO-water reacts with a , a , a , a' , a' , a'-hexachloro-p-xylene to give an insoluble polymer (7205):

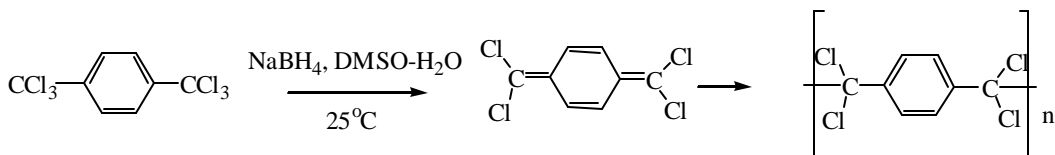

c) Reductions with chromous ion

Reduction of α, α -dichlorobenzyl benzyl sulfoxide to a mixture of diastereomeric α -chlorobenzylbenzyl sulfoxide can be carried out by chromous ion in aqueous DMSO (6972):

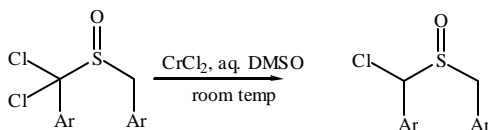

The use of *n*-butanethiol and chromium (II) acetate in DMSO in the reduction of a 5 α -bromo-6 β -hydroxysteroid permits the removal of the bromine and the isolation of the 6 β -hydroxy-steroid (6825)(6970):

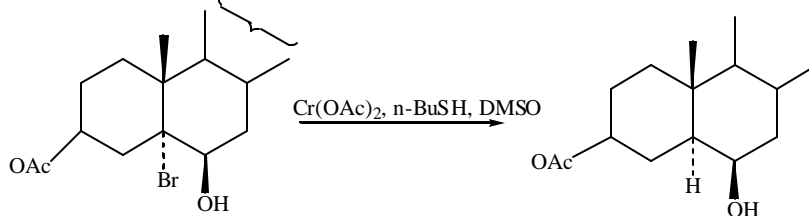

c) Reduction with dimslyl ion

Treatment of 8,8-dibromobicyclo[5,1,0]octane with dimslyl sodium in DMSO produces *exo*-8-bromobicyclo [5,1,0]octane (454)(3009):

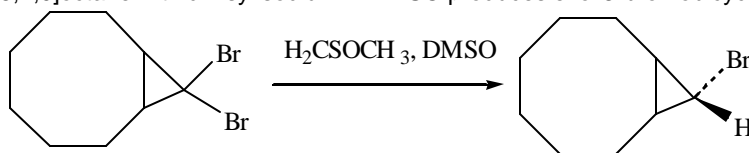

d) Reductions with hydrazine

Hydrazine can reduce *meso*-1,2-stilbene dibromide in DMSO to α -bromostilbene and some bibenzyl (6509):

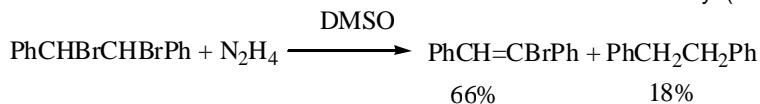

e) Reductions by electrolysis

Controlled potential electrolysis of 2,4-dibromopentanes in DMSO containing tetraethylammonium bromide (TEAB) gives *cis*- and *trans*-dimethylcyclopropanes and small quantities of 1-pentene, 2-pentene and *n*-pentane (4492)(6659):

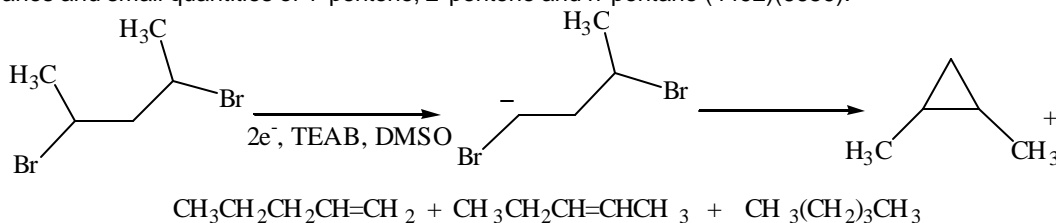

2. Reduction of Carbonyl Compounds

Carbonyl compounds, aldehydes and ketones in DMSO can be reduced by electrochemical means or by Wolff-Kishner reduction of the corresponding hydrazones.

a) Reductions with borohydrides

The kinetics of the reduction of acetone, pivalaldehyde, $(\text{H}_3\text{C})_3\text{CCHO}$, and benzaldehyde by sodium borohydride and tetramethylammonium borohydride have been determined in DMSO-water systems. The reactions obey 2nd order kinetics (8953):

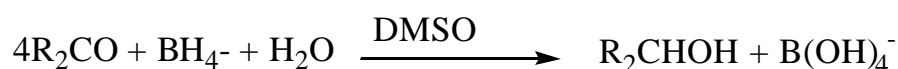

The reduction product of benzaldehyde in DMSO is $\text{NaB}(\text{OCH}_2\text{Ph})_4$, which is readily hydrolyzed to benzyl alcohol, PhCH_2OH (8953). When benzaldehyde is reduced in DMSO and DMSO-water mixtures of tritiated sodium borohydride, the reduction is accompanied by the incorporation of tritium into the aldehyde group of unchanged benzaldehyde (8954).

b) Catalytic reduction

The mechanism of reduction of cyclic ketones by the system iridium(III) salt-sulfoxide-isopropyl alcohol has been investigated. With 4-*t*-butyl cyclohexanone, a 97% conversion to 4-*t*-butylcyclohexanol, with a *cis/trans* ratio of 1.50, can be achieved with DMSO as the sulfoxide (4436):

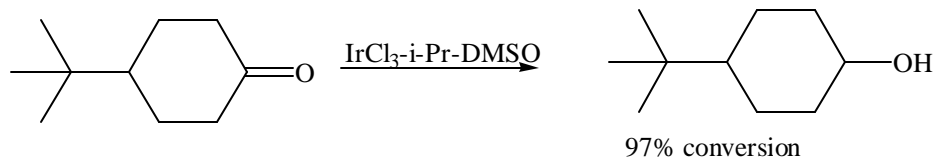

An unusually selective hydrogenation of α, β -unsaturated aldehydes to the unsaturated alcohols has been accomplished catalytically under mild conditions using the iridium complex $\text{HIrCl}_2(\text{DMSO})_2$ in isopropanol, the solvent being the source of hydrogen (9752):

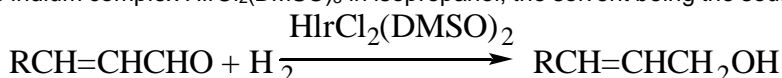

c) Electrochemical reduction

The electrochemical reduction of carbonyl compounds, particularly ketones and diketones, has been studied in DMSO (2567)(3217). The reduction of 1,3-diphenyl-1,3-propanedione in DMSO proceeds by an overall 0.5 electron process (5971):

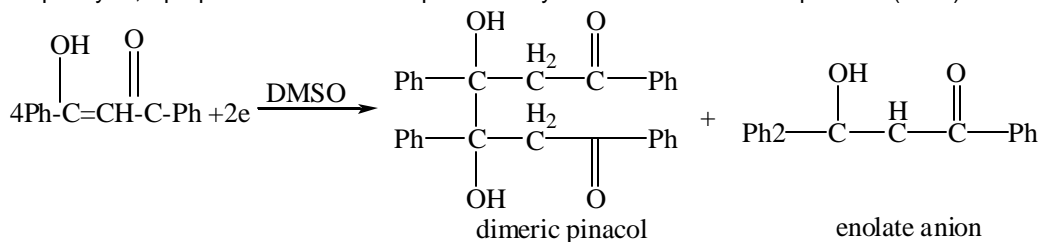

d) Wolff-Kishner reduction

The Wolff-Kishner reduction, the reaction of hydrazones of aldehydes and ketones with a base to produce the corresponding hydrocarbons, has been run in DMSO (495)(377):

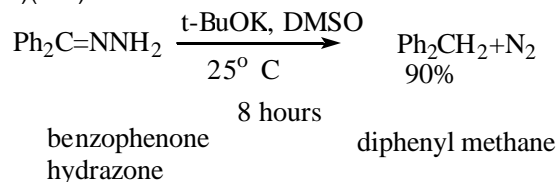

The Wolff-Kishner reduction in DMSO has been carried out in the presence of potassium *t*-butoxide, dimethyl sodium, and other base catalysts, and the activation parameters have been determined (8735). The Wolff-Kishner reaction mechanism in DMSO has been reviewed (1942)(3048).

3. Reduction of nitroaromatics

The reduction of aromatic nitro compounds with sodium borohydride in DMSO initially produces the azoxy compounds which, in most cases, are subsequently reduced to the corresponding azo derivatives and amines (4946), e.g.:

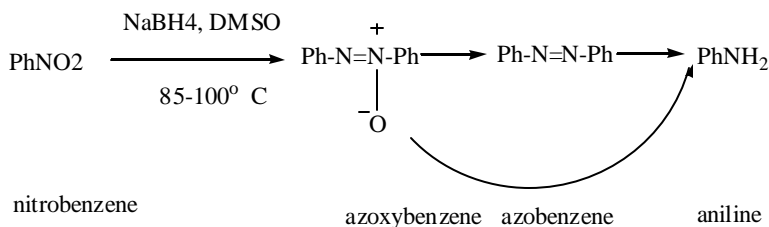

In the case of *o*-nitroanisole, 63% of *o*-methoxyaniline and 23 % of the azobenzene are produced.

Nitroaromatics are selectively hydrogenated in neutral media in the presence of precious metal catalysts and DMSO to produce *N*-arylhydroxyamines in high yield. Thus, nitrobenzene in the presence of platinum on carbon and DMSO yields hydroxylamine and phenyl aniline (5663):

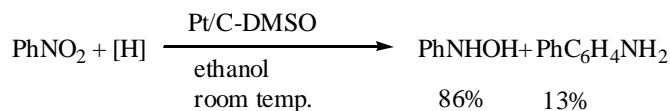

Catalysts of noble metals on activated carbon can be subjected to the action of DM SO together with hydrazine or its derivatives. The hydrogenation of 2-chloronitrobenzene in the presence of platinum on carbon and DMSO gives a high yield of 2-chloroaniline (8118):

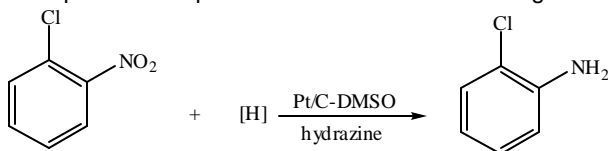

Similarly, the reduction of nitrobenzene with hydrogen over platinum oxide in alcohol (methanol or ethanol)sulfuric acid in the presence of DMSO produces p-alkoxyaniline (9294)(9581):

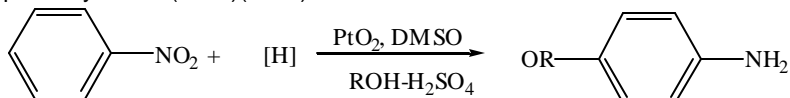

4. Reduction of C=C Systems

The electrochemical reduction of several aryl α , β -unsaturated ketones, $\text{C}_6\text{H}_5\text{CH}=\text{CHCOR}$, has been studied at mercury cathodes by the techniques of polarography, controlled potential coulometry and cyclic voltammetry. Conditions have been established under which a dimer of the α , β -unsaturated ketones is formed by coupling at the β -carbon atoms in good yields. A suitable medium for the reduction is tetra-n-butylammonium perchlorate in DMSO with added lithium perchlorate (4253), e.g.:

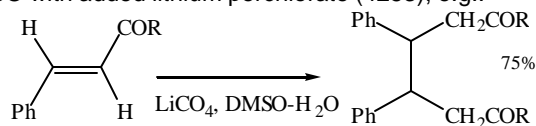

R = t-butyl

Diimide, generated by the sodium metaperiodate oxidation of hydrazine in DMSO, is a particularly useful reducing system for olefins or compounds which contain readily oxidized functional groups (4392), e.g. maleic anhydride can be reduced to succinic anhydride:

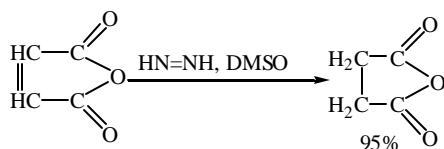

A thiophene derivative is reduced the same way (4392):

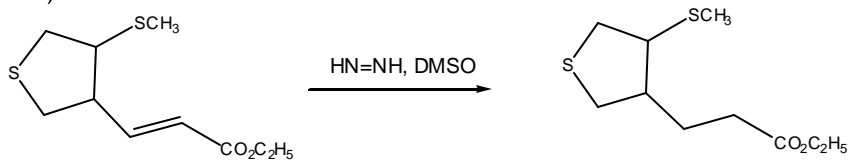

Allylbenzene can be hydrogenated by chloro(DMSO)palladium complexes (5526):



In the presence of the same catalyst, 1-pentene is converted to isomers more rapidly than without the catalyst and the bond migration of the pentene is more rapid than its hydrogenation (5630).

Double bonds in some α , β -unsaturated ketones are reduced by propen-2-ol in the presence of soluble iridium -DMSO catalysts (7031):

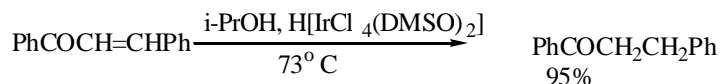

Acrylic acid and its derivatives can be dimerized in high yields by means of alkali metal amalgam in DMSO-water. Acrylonitrile gives adiponitrile (4907):

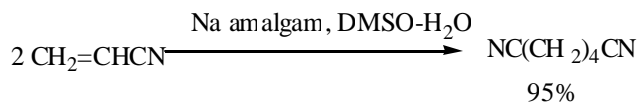

Diethyl fumarate, $\text{C}_2\text{H}_5\text{O}_2\text{CCH}=\text{CHCO}_2\text{C}_2\text{H}_5$, can be dimerized by electrochemical reduction (7331).

SOLVOLYTIC REACTIONS

These are reactions in which the elements of water (also alcohols or amines) are added, usually with the formation of two new substances.

1. Hydrolysis

The DMSO-water system has been used in many hydrolysis reactions. The rates of base catalyzed reactions usually increase as the mole fraction of DMSO in the mixture increases, and the increase is particularly rapid above 0.7 mole fraction of DMSO (336)(367)(369)(464)(726)(730). The opposite is sometimes true in the case of hydrolysis in the presence of acids. The rate of acid hydrolysis decreases as the mole fraction of DMSO is increased, particularly above 25-30% DMSO (368). A similar decrease is seen for the acid catalyzed hydrolysis of acetals (742) and the reaction of tert-butyl chloride with aqueous DMSO (431)(1028)(1521).

a) Aliphatic halide hydrolysis

The alkaline hydrolysis of alkyl halides has been studied in DMSO-water (329)(432)(2583)(4846). In the alkaline hydrolysis of methyl iodide, DMSO exerts a strong accelerating effect. The rate of the hydroxyl ion catalyzed reaction in DMSO is up to 10^6 - 10^7 times the rate in water (329).

The rate constants for the reaction of hydroxyl ion with benzyl chlorides in acetone-water decrease with increasing acetone concentration while the rates increase with increasing DMSO concentration in DMSO-water (432).

The rate of alkaline hydrolysis of chloroacetic acid increases with increasing concentration of the organic component in acetone-water, THF-water, dioxane-water and DMSO-water. However, the increase is greatest in DMSO-water (2583).

Alcohols can be prepared from alkyl halides in DMSO-water in the presence of a base. Thus, octanol is obtained from octyl chloride and calcium hydroxide in DMSO-water at reflux (4846):

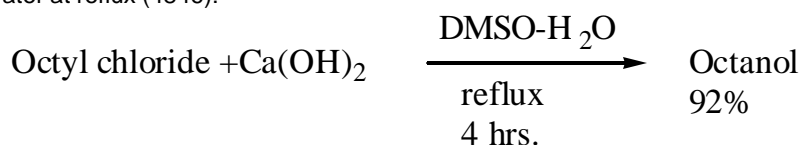

Solvolysis of 2-adamantyl bromide and α -chloroethylbenzene decreases with increasing DMSO content (2194)(3766)(2196).

The Diels-Alder adduct, obtained by reacting 5-methoxymethyl-1,3-cyclopentadiene with chloroacrylonitrile, is converted with aqueous potassium hydroxide in DMSO to the anti-bicyclic ketone (3033):

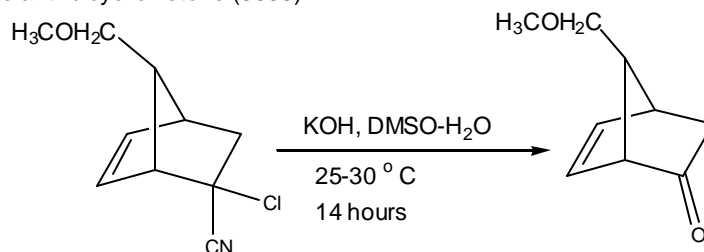

b) Aromatic halide hydrolysis

Aromatic halogens can be hydrolyzed from activated nuclei by aqueous bases in DMSO. The rate coefficients for the alkaline hydrolysis of a series 1-halogen substituted 2,4-dinitrobenzenes have been measured in aqueous DMSO. These rates have been correlated with the acidity function of medium (4467)(4520).

The aryl polyether that is prepared by the reaction of the disodium salt of bisphenol A with 4,4'-dichlorodiphenyl sulfone in DMSO depends on the moisture content of the polymerizing system. In the presence of water, hydrolysis of 4,4'-dichlorodiphenyl sulfone monomer occurs concomitant with the polymerization (4704).

The reaction of 2,8-dibromo-5,5-dioxodibenzothiophene with aqueous potassium hydroxide in DMSO gives 8-bromo-2-hydroxy-5,5-dibenzothiophene (7709):

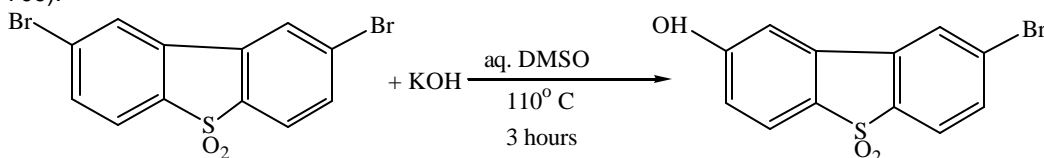

Several 4-halogenophenyl sulfonylphenols, useful for the synthesis of poly(arylene ether sulfones), have been prepared by partial hydrolysis of the corresponding dihalides in DMSO (8825):

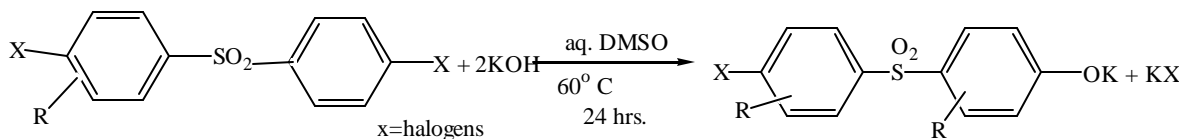

c) Amide hydrolysis

The rates of base catalyzed hydrolysis of anilides have been studied in DMSO-water (3820)(7573)(8696). Even a very small amount of DMSO (less than 1 %) facilitates the kinetic measurements in the hydrolysis of p-nitro- and p-formylacetanilide (3820). Some increase with increasing DMSO has been found in the hydrolysis rate of trifluoroacetanilide (7573).

The reaction of ϵ -caprolactam with barium hydroxide in DMSO-water gives ϵ -aminocaproic acid on acidification (4972):

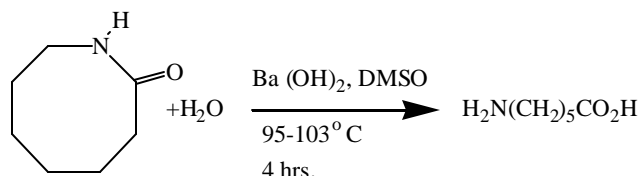

d) Epoxide hydrolysis

The most commonly encountered reactions of epoxides are those in which the ring is opened by a nucleophile. Such reactions are advantageously performed in DMSO because DMSO is inert to the epoxides and it also provides maximum reactivity for the nucleophile. When the relatively unreactive 1-phenylcyclohexene oxide is heated with potassium hydroxide in aqueous DMSO, the corresponding trans-glycol is obtained in fairly good yield (334):

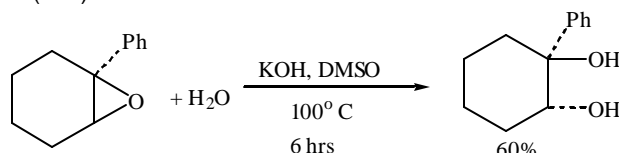

In the presence of acids a mixture of cis- and trans glycols results. The same reaction in aqueous dioxane after 48 hours at 150°C gives only a 10% yield (334).

Treatment of 8,9-epoxyundec-5-en-ol with potassium hydroxide in refluxing aqueous DMSO produces undeca-4,6-diene-3,9-diol (8261):



The same treatment of the saturated epoxide, 8,9-epoxyundecan-3-ol, leads to simple cleavage of the epoxy ring giving undecane-3,4,9-triol (8261):



1-(β , γ -Epoxypropyl)cyclohexan-1-ol, when treated with base in 75% aqueous DMSO, gives the corresponding oxetan as the main product (8306):

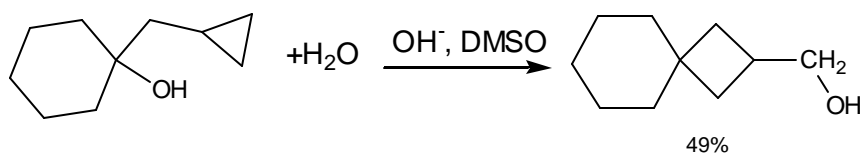

e) Ether hydrolysis

When water, strong acid, and ethyl vinyl ether are all solutes in DMSO, the rate of hydrolysis of the vinyl ether is still controlled by the rate of proton transfer to the carbon. The rate decreases with increasing DMSO concentration (2492)(7643):

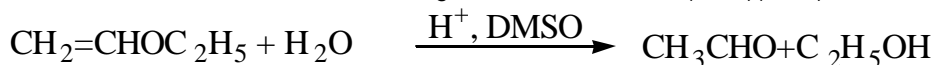

The rate coefficients for the alkaline hydrolysis of 4-substituted 1-methoxy-2-nitrobenzenes and 1-alkoxy 2,4-dinitrobenzenes have been measured in aqueous DMSO. These rates have been correlated with the acidity function of the medium (4467)(4520):

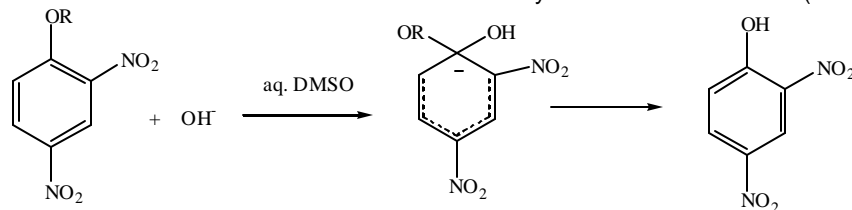

A similar study has been done with substituted 2-alkoxytropones in 40% aqueous DMSO (4521).

2,4,6-Trinitroanisole and 2,4,6-trinitrophenyl phenyl ether react with DMSO to give 2,4,6-trinitrophenol and methanol and phenol, resp. (6878):

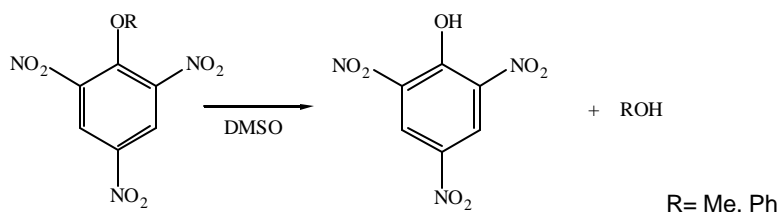

f) Nitrile hydrolysis

Powdered anhydrous sodium hydroxide and potassium hydroxide in DMSO can be used to convert nitriles to amides, e.g. benzonitrile to benzamide, at a reaction rate that is approximately 10,000 times that in aqueous caustic. However, the solubility of the dry caustic in DMSO is very low which reduces the speed of converting the nitrile (725).

The reaction of 5-chloro-1,4-diphenyl-1,2,3-triazole with sodium cyanide in moist DMSO gives 1,4-diphenyl-1,2,3-triazole-5-carboxamide due to hydrolysis of the nitrile (7115):

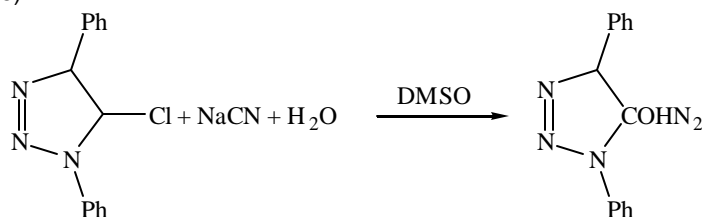

g) Saponification

In the base catalyzed hydrolysis of esters in aqueous DMSO, the rate of hydrolysis increases as the mole fraction of DMSO in the mixture increases. This increase is particularly rapid above 0.7 mol fraction of DMSO (336)(367)(369) (464)(726)(730).

The use of DMSO-water as a solvent for saponification increases the reaction rate difference between the first and second group of diesters. In 50% aqueous DMSO (v/v) the first ester group can be hydrolyzed more than nine times faster than the second one (1694). There is a considerable rate enhancement for both steps in alkaline hydrolysis of a series of dicarboxylic acid esters in DMSO-water. The rates increase with increasing amount of DMSO and these rates are larger in aqueous DMSO than in aqueous ethanol (5969)(6543) or aqueous acetonitrile (5459).

When the saponification of glycol monobenzoates are carried out in 80% aqueous DMSO, 80% aqueous ethanol and 80% aqueous acetone, the rates are up to 1000 times faster in 80% aqueous DMSO than in the other two solvent systems (5622):

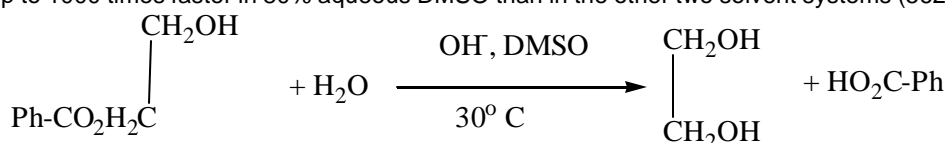

Similarly, the saponification rates of unsaturated esters in DMSO-water are faster than in ethanol-water (3356) (7540). Increased transition state solvation, not increased hydroxyl ion desolvation, is the major cause of rate enhancement in DMSO (6822).

The rate coefficients of neutral hydrolysis of methyl trifluoroacetate and chloromethyl dichloroacetate in DMSO-water are greater than in acetone-water and acetonitrile-water (6477).

With hydrolysis on the acid side, however, the reaction rate decreases as the mole fraction of DMSO increases above 25-30% DMSO, as is the case with ethyl acetate (368).

The cleavage of highly hindered esters can be accomplished in DMSO using potassium t-butoxide as the base and heating until the cleavage is accomplished. In this case, the cleavage occurs by alkyl-oxygen fission (490). Esters are also cleaved by sodium superoxide in DMSO to give carboxylic acids in excellent yield, as is the case of ethyl p-cyanobenzoate (10086).

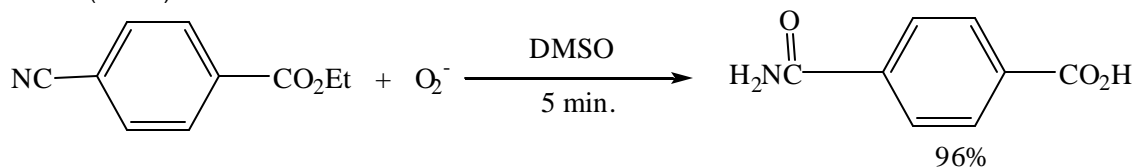

2. Alcoholysis, Aminolysis

In the basic methanolysis of some aryl substituted N-methyl-2,2,2-trifluoroacetanilides in DMSO-methanol rate increases with increasing amount of DMSO (6474):

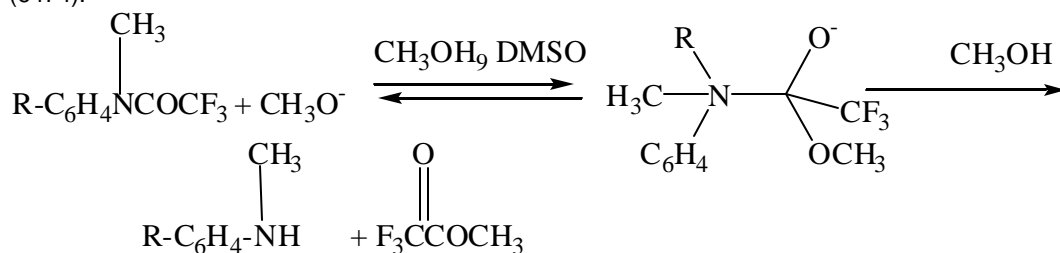

N-Methyl-4'-nitroanilides undergo basic methanolysis by way of rate determining methoxide addition to the amide, as shown above. The addition of DMSO produces a rate increase in each case (7844).

The mechanism of basic methanolysis of a series of N-aryl-N-phenylbenzamides in methanol and in 80% DMSO-methanol has been studied. In methanol the rate determining step seems to be the solvent assisted C-N bond breaking, while in 80% DMSO-methanol the rate determining step is methoxide attack (10409).

Markedly increased alcoholysis rates are obtained by the addition of DMSO to ethylene-vinyl ester interpolymer alcohol mixtures in the presence of either alkaline or acidic mixtures (7156).

DMSO is an effective catalyst for the n-butylaminolysis of p-nitrophenyl acetate in chlorobenzene (6988).

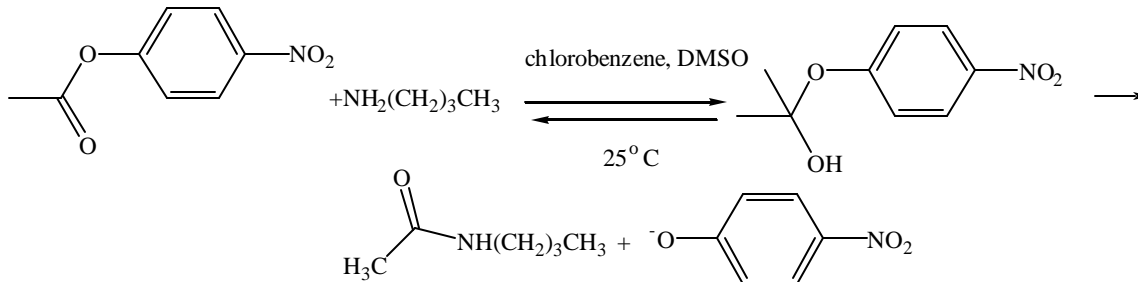

The aminolysis of polymeric macronet N-hydroxy-succinimide esters of Boc-amino acids and peptides in DMSO has been studied, both in the presence and in the absence of organic bases (8832).

3. Transesterification (Ester Interchange)

The reported work concerning the base catalyzed transesterification of fatty acid esters mainly describes esterification of carbohydrates and other polyhydroxylic materials. DMSO is a particularly suitable solvent in this area because of the enhanced activity of the base catalyst in DMSO and also because of the excellent solubility of most carbohydrate and polyhydroxylic substances in DMSO. A number of the reports are concerned with sucrose esters (160)(161)(181)(162)(164)(165). Others report esterifying hexitols and hexoses (1257) and inositols (166). The reaction of 1,2-O-isopropylidene-6-tosyl-glucose under the conditions of the Kornblum oxidation with potassium bicarbonate as the base gives none of the expected aldehyde but only the 5,6-carbonate ester(183) in a transesterification.

Alkylation of methyl O-(tetrahydropyran-2-yl) mandelate using alkyl halides and sodium hydride in DMSO at 80°C produces transesterification products (4278):

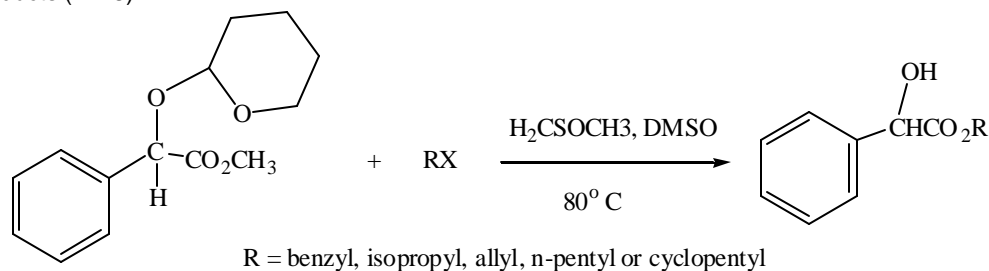

Dimethyl terephthalate can be polymerized with ethylene glycol in the presence of a tin chloride-DMSO complex and trimethylphosphate to give a poly(ethylene terephthalate) (7255).

Thermoplastic polymers derived from natural products have been prepared by interesterifying starch with methyl palmitate in DMSO with potassium methoxide as the catalyst (8227).

PART V USES

1. Polymerization and Spinning Solvent

DMSO is used as a solvent for the polymerization of acrylonitrile and other vinyl monomers, e.g. methyl methacrylate (9638) and styrene (5192). Acrylonitrile is readily soluble in DMSO and the polymerization is carried out by the addition of initiators (8184)(8185). The low incidence of transfer from the growing chain to DMSO leads to high molecular weights. Copolymerization reactions of acrylonitrile with other vinyl monomers can also be run in DMSO. Monomer mixtures consisting of acrylonitrile, styrene, vinylidene chloride, methallyl sulfonic acid, styrene sulfonic acid, etc. are polymerized in DMSO-water (6713). In some cases, the fibers are spun from the reaction solution into DMSO-water baths (8501)(8603).

DMSO can also be used as a reaction solvent for other polymerizations. Thus, ethylene oxide is rapidly and completely polymerized in DMSO (9652). Diisocyanates and polyols and polyamines can be dissolved and reacted in DMSO to form solutions of polyurethanes (8677).

Polymerization Solvent for Heat Resistant Polymers. Poly(ether sulfones) are a family of polymers from which a series of tough thermoplastics can be selected for use under continuous stress in the temperature range of 150-250°C (7196)(7619). These poly(ether sulfones) are prepared by reacting dialkali metal salts of a bisphenol, such as bisphenol A or 4,4'-sulfonyldiphenol with 4,4'-dihyalodiphenyl sulfones by the displacement etherification reaction in DMSO (7104)(9961), e.g.:

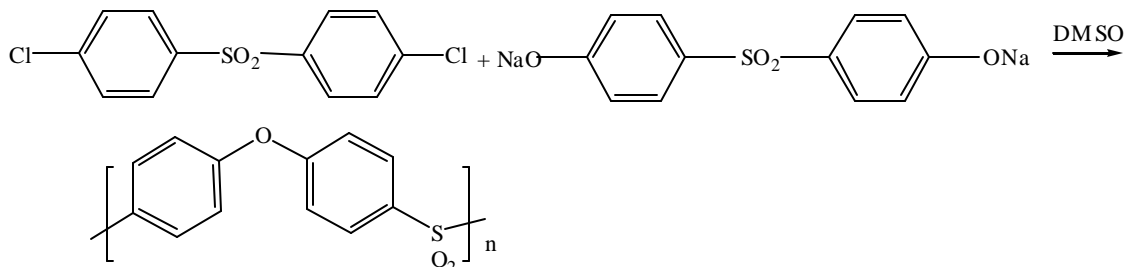

Interest in heat-resistant polymers has also led to the development of polyetherimides. These polymers are prepared by the reaction of a dialkali metal salt of a bisphenol, such as bisphenol A or 4,4'-sulfonyl diphenol, with bis(halophthalimide) in DMSO as the solvent (9686). In place of bis(halophthalimides), certain bis(nitrophthalimides) in DMSO can be used (10434):

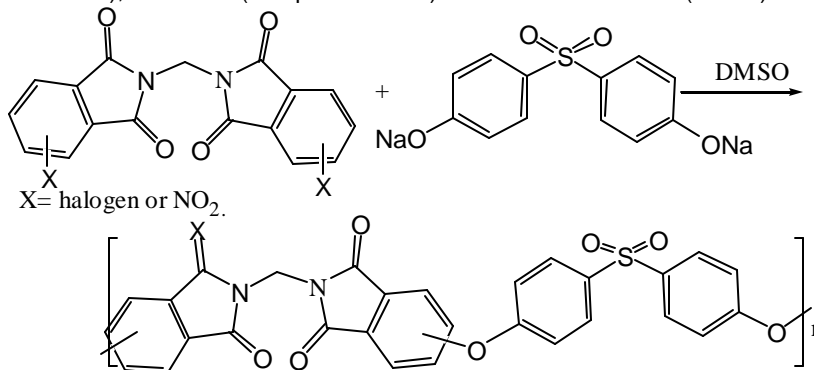

Somewhat similar polyetherimides can be prepared by reacting an aromatic bis(ether dicarboxylic acid) component with a diamine in DMSO-water (10762):

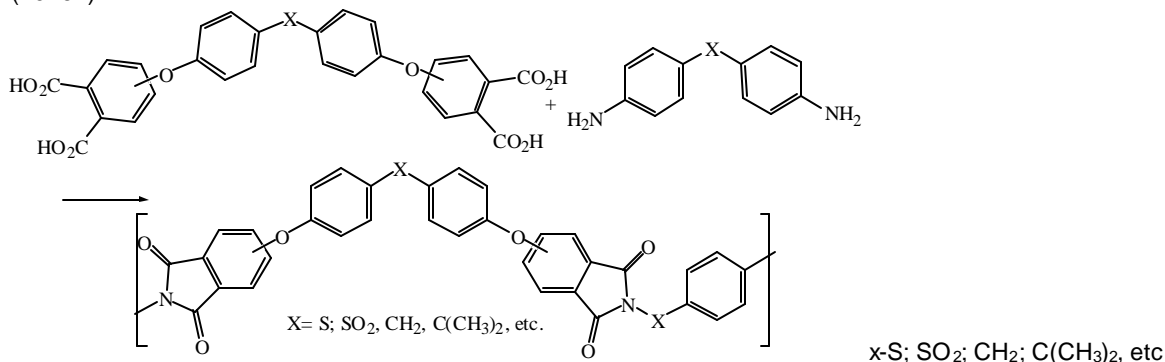

2. Extraction Solvent

DMSO is immiscible with alkanes but a good solvent for most unsaturated and polar compounds. Thus it can be used to separate olefins from paraffins (10771). DMSO is used in the Institute Francais du Petrole (IFP) process for extracting aromatic hydrocarbons from refinery streams (8554). DMSO is also used in the analytical procedure for determining polynuclear hydrocarbons in food additives of petroleum origin (2371).

3. Solvent for Electrolytic Reactions

DMSO has been widely used as a solvent for polarographic studies and it permits the use of a more negative cathode potential than in water. In DMSO cations can be successfully reduced to form metals that would react with water. Thus, the following metals have been electrodeposited from their salts in DMSO: cerium (1749), actinides (2520), iron, nickel, cobalt, manganese – all amorphous deposits; zinc, cadmium, tin, bismuth – all crystalline deposits; (5488); chromium (6672), silver (7459), lead (9175), copper (9396), titanium (7260). Generally, no metal less noble than zinc, such as magnesium or aluminum, can be deposited from DMSO.

4. Cellulose Solvent

Although DMSO by itself does not dissolve cellulose, the following binary and ternary systems are listed as cellulose solvents: DMSO-methylamine, DMSO-sulfur trioxide, DMSO-carbon disulfide-amine, DMSO-ammoniasodamide, DMSO-dinitrogen tetroxide, DMSO-paraformaldehyde (8970)(10368), DMSO-sulfur dioxide-ammonia (9541). A least a ratio of 3 moles of active agent per mole of glucose unit is necessary for complete dissolution (8970). While only 80% of cellulose dissolves in DMSO-methylamine under cold anhydrous conditions (10368), DMSO-nitrogen tetroxide is a better solvent, particularly when a small quantity of water is added (9170). Most of these systems are capable of producing cellulose fibers. The recently discovered DMSO-paraformaldehyde system does not degrade cellulose and it can form solutions containing up to 10% cellulose (7763)(8506)(9850). It is believed that a methylol-cellulose compound forms which is stable for extended periods of storage at ambient conditions (9850). Regenerated cellulose articles such as films and fibers can be prepared by contacting the DMSO-paraformaldehyde solution with methanol and water (9850)(9895).

5. Pesticide Solvent

Many organic fungicides, insecticides and herbicides are soluble in DMSO, including such difficultly soluble materials as the substituted ureas and carbamates. DMSO forms cosolvent systems of enhanced solubility properties with many solvents.

6. Cleanup Solvent

DMSO is used to remove urethane polymers and other difficultly soluble materials from processing equipment. Hard crusts of poly(vinyl chloride) resin can be dissolved by using 85:15 ethyl acetate-DMSO mixture (8927).

7. Sulfiding Agent

DMSO (ENVIRO-S) can be used as a sulfiding agent in refineries because of its low odor, low toxicity and ease of handling.

8. Integrated Circuits

DMSO solutions are useful for etching resists in integrated circuit manufacture.

PART VI TOXICITY, HANDLING, HAZARDS, ANALYSIS

1. Toxicity and Handling Precautions

Dimethyl sulfoxide is a relatively stable solvent of low toxicity. The LD₅₀ for single dose oral administration to rats is about 18,000 mg/kg. For comparison, the LD₅₀ for ethyl alcohol is about 13,700 mg/kg. DMSO by itself presents less hazard than many chemicals and solvents commonly used in industry. However, DMSO has the ability to penetrate the skin and may carry with it certain chemicals with which it is combined under certain conditions.

The toxicity of DMSO solutions will depend, in part, on the nature and toxicity of the other chemicals used and the degree of penetration. The degree of penetration is determined by the concentration of DMSO and water in the solution and the length of time of skin contact. Not all chemicals will be carried through the skin even though the DMSO may penetrate. A 10% solution of DMSO in water causes only slight increase in skin penetration over the same solution without DMSO.

Conventional industrial safety procedures and practices should be observed when working with DMSO as with any organic solvent. Protective clothing is not necessary when handling DMSO in containers or in small amounts on limited occasions. However, when working with DMSO on a prolonged basis or in combinations with other materials, protective clothing is recommended, including suitable gloves or eye protectants. Butyl rubber gloves are suggested for DMSO service.

Contacts with DMSO Alone

Skin: Undiluted DMSO may have a mildly irritating effect on the skin and should be washed off promptly with cold water. As is the case with other organic solvents, dimethyl sulfoxide tends to dehydrate and de-fat the skin. Repeated skin contact over extended periods should be avoided since the effects of such contact, if any, are not yet known.

Eyes: DMSO in contact with the eye may cause temporary irritation but will not result in eye damage if washed out promptly with cold water.

Vapors: The normal ambient airborne DMSO concentration is low. (DMSO has a high boiling point, 189°C or 372°F, and a low vapor pressure.) Inhalation of vapors of hot DMSO or DMSO aerosol mists may be harmful and should be avoided.

Contact with DMSO solutions: When handling solutions of possibly toxic substances in DMSO, care must be taken to avoid contact with the skin and to wash such solutions off immediately and thoroughly with soap and water. If toxic substances penetrate into the system, serious harm may occur. Clothing contacted by such solutions should be removed and washed before reusing.

2. Comparative Toxicity of Commercial Solvents

All solvents are toxic to some extent, but DMSO is much less so than many in common usage. Toxicity, as measured by dermal and oral LD₅₀ in rats, is shown for a number of common solvents. They are listed in order of increasing oral toxicity.

TABLE XII
Single-Dose Toxicity (Rats) of Some Common Solvents

Solvent	LD ₅₀ , mg/kg	
	Oral	Dermal
Glycerine	31600	10000
DMSO	17400	40000
Ethanol	13700	-
Acetone	9750	-
Dimethylacetamide	7500	5000
Ethylene glycol	7200	-
N-methyl-2-pyrrolidone	7000	-
Trichloroethylene	5860	-
Isopropanol	5840	-
n-Propanol	4300	-
Benzene	4080	-
Diacetone alcohol	4000	-
Methyl ethyl ketone	3980	-
Xylene	3830	10000
Cyclohexanone	3460	-
Acetic acid	3310	-
n-Butanol	2610	5620
2-Heptanol	2580	-
Butyl cellosolve	2380	-
Dimethylformamide	2250	442
Sodium lauryl sulfate	1650	10000
Pyridine	891	1120
Aniline	442	1540
Phenol	14*	-

* Approximate lethal dose.

Most of the solvents in the above table were chosen because, like DMSO, they are polar. Several studies have been made in comparing the toxicity of DMSO with other solvents. Table XIII shows the results of one of these studies.

TABLE XIII
Single-Dose Toxicities to Mice of 4M Solutions

LD₅₀, mg/kg (mice)

Compound	Intravenous	Intraperitoneal
DMSO	7176	14664
Glycerine	6164	6900
Dimethyl formamide	3650	6570
Dimethyl acetamide	3915	5916
N-methyl pyrrolidone	1980	3564

3. Chemicals and Reactions to be Avoided with DMSO

DMSO can react vigorously and even explosively with iodine pentafluoride, periodic acid, potassium permanganate, silver fluoride and other strong oxidizing agents such as magnesium perchlorate and perchloric acid.

DMSO cannot be used in Friedel-Crafts reactions or with Ziegler-Natta catalysts.

DMSO reacts vigorously with acid chlorides. These reactions proceed with about the same vigor as the reaction between acid chlorides and ethyl alcohol, and suitable precautions should be taken.

DMSO also reacts with carboxylic acid anhydrides, such as acetic anhydride, the major product being the acyloxymethyl methyl sulfide, RCO₂CH₂SCH₃.

Adequate heat removal should be provided when reacting DMSO with sodium hydride or potassium hydride when making the DMSO anion (dimethyl ion) (Please see PART III, Reactions of DMSO, 4. Reaction with Strong Bases).

An uncontrolled reaction took place when DMSO was heated with methyl bromide to prepare trimethylsulfonium bromide. This

reaction should be run in the presence of compounds that remove HBr or Br₂, such as methyl or ethyl orthoformate or tetramethyl orthocarbonate. These esters act as scavengers of HBr and Br₂, produced as byproducts in the reaction. Thus, the possible violent exothermic decomposition of the reaction mixture can be prevented with little, if any, loss in the yield of the product (9964).

4. Analytical Procedure

a) Gas chromatographic analysis of DMSO

Apparatus

Gas chromatograph with flame ionization detector and a 4 ft. x 1/8 inch o.d. stainless steel column packed with 15% FFAP (Varian Aerograph) on Chromosorb T (Johns-Manville), 40/60 mesh.

1.0 microliter syringe.

Chromatograph Conditions

Temperatures: Column - 150°C, Detector - 220°C, Inlet - 210°C Carrier gas flow - 30 ml/min

Adjust the instrument sensitivity so that a 0.5 microliter sample will give a DMSO peak between 75 and 100% of recorder full scale.

Procedure

Inject 0.5 microliters of the DMSO. Record the DMSO peak at the sensitivity determined above. Record the period before and after the DMSO peak at 100 times this sensitivity. Record the chromatogram for 20 minutes. Sum the areas of any extraneous peaks.

Calculations

$$\% \text{ Impurities} = \frac{\text{Total area of extraneous peaks}}{\text{Area of DMSO Peak}}$$

b) DMSO Freezing Point

Pour 30-50 ml of DMSO into a clean, dry test tube, approximately 2.5x20 cm in size and fitted with a stopper containing thermometer and also containing a small magnetic stirring bar.

Cool the test tube in water at 15°C while agitating with a magnetic stirrer until crystallization starts. Once crystallization has begun read the thermometer while both liquid and solid DMSO are present. Purified DMSO - 18.3°C minimum (See Figure 2b, page 5)

c) Water Determination by Karl Fischer Titration

Discussion

Water is determined by Karl Fischer titration. Karl Fischer procedures other than the one described below may be used provided that their accuracy in this analysis has been determined.

Scope

This procedure may be used with all grades of DMSO.

Reagents

1. Pyridine-SO₂-methanol.

Mix 300 ml. C.P. pyridine and 300 ml anhydrous methanol. Bubble in 60 grams of SO₂. This can be done with the solution on a platform balance to weigh directly the SO₂ added.

2. Anhydrous methanol.

3. Karl Fischer Reagent - stabilized.

Fischer Scientific SO-K-3

4. Water-methanol standard.

1 ml = 1 mg of water. Can be obtained commercially.

Apparatus

Titration Assembly

The titration is contained in a screwcap glass jar of 100-200 ml capacity. The cap is drilled to admit 2 platinum electrodes and one burette tip. During the titration the jar is mounted over a magnetic stirrer with the electrodes extending through the cap into the solution to be titrated. Reagents and sample are added through the third hole and a micro burette containing Karl Fischer Reagent is mounted above the third hole.

A preferred alternate to the above assembly can be constructed from both halves of a large diameter glass ball and socket joint.

End-Point Detecting Assembly

The end-point detecting assembly is of the "dead stop" type, which depends upon the depolarization of the electrodes on reaching the end-point of the titration.

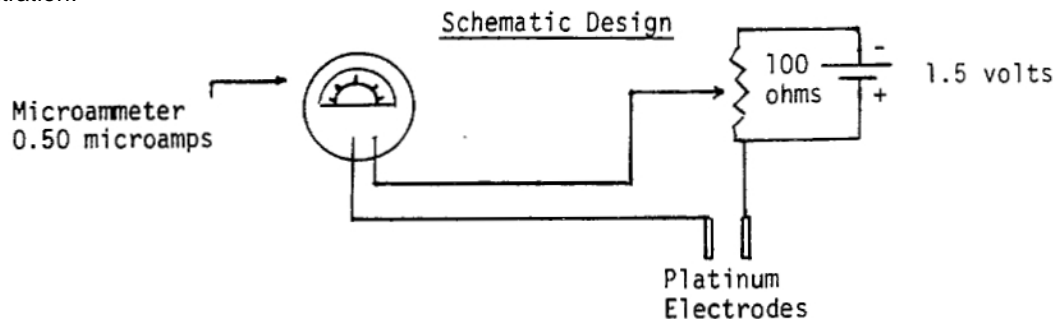

Procedure

End-Point Detection

With the equipment set up as described and the material to be titrated in the bottle, start the magnetic stirrer. Adjust the variable resistance to produce a microammeter deflection of 1 or 2 microamps. Titrate with Karl Fischer Reagent. As the end-point is neared, the ammeter needle starts to swing with each addition of titrant, but returns to the original point of deflection after each swing. When the end-point is reached the needle will remain permanently displaced up scale.

Standardization of Reagents

$$\text{Water equivalence} = \frac{\text{grams of water titrated}}{\text{ml of Karl Fischer Reagent}}$$

The Karl Fischer solution must be standardized daily. Add 20 ml of anhydrous methanol and 5 ml of the pyridine-SO₂-methanol solution to the titration bottle (Note 1). Add Karl Fischer Reagent dropwise from a microburette to the end-point. Accurately pipette 20 ml of the water-methanol standard (a weighed amount of pure water may be used) into the titration bottle and titrate with Karl Fischer Reagent to the end-point. Record the volume of titrant used in the second titration and calculate its water equivalence.

Determination of Water

$$\% \text{ Water} = \frac{\text{ml Karl Fischer Reagent} \times \text{water equivalence} \times 100}{\text{Weight of DMSO}}$$

Add 20 ml of anhydrous methanol and 5 ml of the pyridine-SO₂-methanol solution to a clean titration bottle. Add Karl Fischer Reagent dropwise to the end-point. Add 2 to 3 grams (accurately weighed) of the DMSO to be tested (Notes 2, 3, and 4). Titrate with Karl Fischer Reagent to the end-point. Record the volume of titrant used in the second titration and calculate the water content of the dimethyl sulfoxide.

Notes

1. Response tends to be slow with the stabilized Karl Fischer Reagent. A sharper end-point is obtained with the addition of the pyridine-SO₂-methanol solution to the titration vessel.
2. DMSO is extremely hygroscopic. Exposure of the sample to atmospheric moisture must be kept to a minimum.
3. Samples larger than 2-3 grams of DMSO produce low results.
4. For convenience, with a sacrifice of accuracy, a 2 or 3 ml. volume of DMSO can be sampled with a volumetric pipette. The weight of DMSO samples is calculated by multiplying the volume in ml. by 1.10 (the specific gravity of pure DMSO @ 20°C.).
5. A titration assembly such as a Beckman Model KF-2 Aquameter may be used for the titration.

PART VII BIBLIOGRAPHY

- | | |
|----|--|
| 1 | Traynelis, V.J.; Hergenrother, W.L. J. Org. Chem. 29, 221-222 (1964). |
| 8 | French, F.A. Chem. & Eng. News, 48 (April 11, 1966). |
| 17 | Allen, F.M. Crown Zellerbach, results unpublished. |
| 22 | Parker, A.J. Sci. & Technol. (August 1965). |
| 26 | Turner, H.S.; Warne, R.J. Brit. Patent 946,989 (CO7D) (Jan. 15, 1964). |
| 42 | Daiichi Seiyaku Co. Ltd. Japan 10051/65; CA 63 5659B (1965). |
| 49 | Fuqua, S.A.; Duncan, W.G.; Silverstein, R.M. Tetrahedron Lett., No. 9, 521-523 (1965). |

- 84 Modena, G.; Scorrano, G.; Landini, D.; Montanari, F. *Tetrahedron Lett.*, No. 28, 3309-3313 (1966).
- 85 Krueger, J.H. *Inorg. Chem.* 5, 132-135 (1966).
- 86 Saytzeff, A. *Ann.* 144, 148-156 (1967).
- 99 Johnson, M.D. *J. Chem. Soc.* 805-806 (1965).
- 101 Bottini, A.T.; Corson, F.P.; Bottner, E.F. *J. Org. Chem.* 30, 2988-2994 (1965).
- 105 Nace, H.R.; Monagle, J.J. *J. Org. Chem.* 24, 1792-1793 (1959).
- 106 Kornblum, N.; Jones, W.J.; Anderson, G.J. *J. Am. Chem. Soc.* 81, 4113-4114 (1959).
- 109 Elias, H.; Krutzik, S. *Ber.* 99, 1026-1031 (1966).
- 160 D'Amato, V. U.S. 3,054,789 (C1. 260-234) (Sept. 18, 1962).
- 161 Osipow, L.I.; York, W.C. U.S. 2,903,445 (C1. 260-211.5) (Sept. 8, 1959).
- 162 Hass, H.B.; Snell, F.D.; York, W.C.; Osipow, L.I. U.S. 2,893,990 (C1. 260-234) (July 7, 1959).
- 164 Distillers Co., Ltd. *Brit. Pat.* 859, 305 (CO7C) (Jan. 13, 1961).
- 165 Hass, H.B. U.S. 2,970,142 (C1. 260-234) (Jan. 31, 1961).
- 166 Huber, W.F. U.S. 2,997,490 (C1. 260-410) (Aug. 22, 1961).
- 167 Scheidt, K.H.; Kampe, W. *Angew. Chem. Int. Ed.* 4, 787 (1965).
- 172 Pfitzner, K.E.; Moffatt, J.G. *J. Am. Chem. Soc.* 87, 5661-5670 (1965).
- 173 Pfitzner, K.E.; Moffatt, J.G. *J. Am. Chem. Soc.* 87, 5670-5678 (1965).
- 175 Pfitzner, K.E.; Moffatt, J.G. *J. Am. Chem. Soc.* 85, 3027-3028 (1965).
- 181 Huber, W.F.; Tucker, N.B. U.S. 2,812,324 (C1. 260-234) (Nov. 5, 1957).
- 183 Brousse, E.; Lefort, D. *Compt. Rend.* 261, GP8, 1990-1991 (1965).
- 193 Bloomfield, J.J. *J. Org. Chem.* 27, 2442-2746 (1962).
- 202 Russell, G.A.; Weiner, S.A. *J. Org. Chem.* 31, 248-251 (1966).
- 203 Iwai, I.; Ide, J. *Chem. Pharm. Bull. (Tokyo)* 13(6), 663-672 (1965).
- 206 O'Connor, D.E.; Lyness, W.I. *J. Org. Chem.* 30, 1620-1623 (1965).
- 208 Onodera, K.; Hirano, S.; Kashimura, N. *J. Am. Chem. Soc.* 87, 4651-4652 (1965).
- 211 Fletcher, T.L.; Pan, H.L. *J. Am. Chem. Soc.* 78, 4812 (1965).
- 217 Izzo, P.T. *J. Org. Chem.* 28, 1713-1715 (1963).
- 229 Johnston, H. U.S. 3,051,757 (C1. 260-607) (Aug. 28, 1962).
- 232 Weaver, E.E.; Keim, W. *Proc. Indiana Acad. Sci. for 1960*, Vol. 70, 123-131 (1961).
- 240 Greenwald, R.; Chaykovsky, M.; Corey, E.J. *J. Org. Chem.* 28, 1128-1129 (1963).
- 264 Fletcher, T.L.; Pan, H.L. *J. Org. Chem.* 24, 141-142 (1959).
- 272 Legault, R.R.; Groves, K. *Anal. Chem.* 29, 1495-1496 (1957).
- 273 Kornblum, N.; Powers, J.W.; Anderson, G.J.; Jones, W.J.; Larson, H.O.; Levand, O.; Weaver, W.M. *J. Am. Chem. Soc.* 79, 6562 (1957).
- 290 Horner, L.; Kaiser, P. *Liebigs, Ann. Chem.* 626, 19-25 (1959).
- 291 Pae, S.; Kitao, T.; Kawamura, S.; Kitaoka, Y. *Tetrahedron* 19, 817-820 (1963).
- 294 Rat, R.; Sweeting, O.J. *Tetrahedron Lett.* No. 8, 529-532 (1963).
- 296 Goethals, E.; DeRadzitzky, P. *Bull. Soc. Chim. Belg.* 73 546-559 (1964).
- 302 Claypool, D.C.; Lard, E.W. *Chem. Eng. News* 38, 46-47 (Nov. 21, 1960).
- 308 King, C. *J. Org. Chem.* 25, 352-356 (1960).
- 312 Kuryla, W.C. *J. Appl. Polymer Sci.* 9, 1019-1040 (1965).
- 321 Soczewinski, E. *J. Chromatog.* 11, 275-277 (1963).
- 324 Smith, S.G.; Winstein, S. *Tetrahedron* 3, 317-319 (1958).
- 328 Murto, J.; Hiio, A.M. *Suomen Kemistilehti* B37, 177-180 (1964).
- 329 Murto, J. *Suomen Kemistilehti* B34, 92-98 (1961).
- 334 Berti, G.; Macchia, B.; Macchia, F. *Tetrahedron Lett.* No. 38, 3421-3427 (1965).
- 336 Tommila, E. *Suomen Kemistilehti* 37B, 117-120 (1964).
- 342 Schlafer, H.L.; Schaffernicht, W. *Angew. Chem.* 72, 618-626 (1960).
- 348 Thomas, R.; Eriks, K. *Dissertation Abstracts* 26, No. 6, 3069-3070 (Dec. 1965).
- 353 Mackle, H.; O'Hare, P.A.G. *Trans. Farad. Soc.* 58, 1912-1915 (1962).
- 154 Lindberg, J.J. *Finska Kemistsamfundets Medd* 70, 33-39 (1961).
- 365 Webb, R.L. U.S. 3,280,177 (C1. 260-489) (Oct. 18, 1966).
- 366 Bay, P.G. U.S. 3,270,761 (C1. 260-307) (Sept. 21, 1965).
- 367 Tommila, E.; Murto, M.-L. *Acta Chem. Scand.* 17, 1947-1956 (1963).
- 368 Tommila, E.; Murto, M.-L. *Acta Chem. Scand.* 17, 1957-1970 (1963).
- 369 Tommila, E.; Palenius, I. *Acta Chem. Scand.* 17, 1980-1984 (1963).
- 372 Douglas, T.B. *J. Am. Chem. Soc.* 70, 2001-2002 (1948).
- 377 Szmant, H.H.; Roman, M.N. *J. Am. Chem. Soc.* 88, 4034-4039 (1966).

385 Gundermann, K.D.; Holtmann, P. *Angew. Chem. Int. Ed.* 5, 668 (1966).
 386 Fukui, K.; Tanimoto, f.; Kitano, H. *Bull. Chem. Soc. Japan* 38, No. 10, 1586-1589 (1965).
 390 Emerson, D.W.; Booth, J.K. *J. Org. Chem.* 30, No. 7, 2480-2481 (1965).
 391 Appel, R.; Rittersbacher, H. *Ber.* 97, 852-856 (1964).
 392 Dyer, E.; Glenn, J.F.; Lendrat, E.G. *J. Org. Chem.* 26, 2919-2925 (1961).
 394 Traynelis, V.J.; Hergenrother, W.L.; Hanson, H.T.; Valicenti, J.A. *J. Org. Chem.* 29, 123-129 (1964).
 396 Baker, R.; Spillett, M.J. *Chem. Comm.* 757-758 (1966).
 398 Bader, H.; Hansen, A.R.; McCarty, F.J. *J. Org. Chem.* 31, 2319-2321 (1966).
 399 Kingsbury, C.A. *J. Org. Chem.* 29, 3262-3270 (1964).
 402 Murto, J. *Suomen Kemistilehti B38*, 49-50 (1965).
 405 Traynelis, V.J.; Hergenrother, W.L.; Livingston, J.R.; Valicenti, J.A. *J. Org. Chem.* 27, 2377-2383 (1962).
 407 Kingsbury, C.A. *J. Am. Chem. Soc.* 87, 5409-5416 (1965).
 408 Nace, H.R. *J. Am. Chem. Soc.* 81, 5428-5430 (1959).
 409 Kaiser, C.; Trost, B.M.; Beeson, J.; Weinstock, J. *J. Org. Chem.* 30, 3972-3975 (1965).
 411 Argabright, P.A.; Hofman, J.E.; Schriesheim, A. *J. Org. Chem.* 30, 3233-3235 (1965).
 423 Walling, C.; Bollyky, L. *J. Org. Chem.* 29, 2699-2701 (1964).
 428 Wallace, T.J. *J. Am. Chem. Soc.* 86, 2018-2021 (1964).
 429 Bottini, A.T.; Bottner, E.F. *J. Org. Chem.* 31, 389-391 (1966).
 431 Tommila, E. *Acta Chem. Scand.* 20, 923-936 (1966).
 432 Tommila, E.; Pitkanen, I.P. *Acta Chem. Scand.* 20, 937-945 (1966).
 433 Tommila, E.; Savolainen, M. *Acta Chem. Scand.* 20, 946-962 (1966).
 434 Cram, D.J.; Rickborn, B.; Knox, G.R. *J. Am. Chem. Soc.* 82, 6412-6413 (1960).
 438 Finger, G.C.; Kruse, C.W. *J. Am. Chem. Soc.* 78(12), 6034-6037 (1956).
 440 Argabright, P.A.; Rider, H.D.; Sieck, R. *J. Org. Chem.* 30, 3317-3321 (1965).
 442 Solar, S.L.; Schumaker, R.R. *J. Org. Chem.* 31, 1996-1997 (1966).
 443 Adams, A.R. U.S. 3,007,763 (C1. 8-11602) (Nov. 7, 1961).
 449 Wyart, J.W.; Vona, J.A.; Cunningham, R.R. U.S. 3,061,629 (C1. 260-471) (Oct. 30, 1962).
 450 Farago, J. U.S. 3,004,945 (C1. 260-30.8) (Oct. 17, 1961).
 454 Osborn, C.L.; Shields, T.C.; Shoulders, B.A.; Cardenas, C.G.; Gardner, P.D. *Chem. & Ind.* 766-767 (1965).
 455 Cardenas, C.G.; Khafaji, A.N.; Osborn, C.L.; Gardner, P.D. *Chem. & Ind.* 345-346 (1965).
 459 Amonoo-Neizer, E.H.; Ray, S.K.; Shaw, R.A.; Smith, B.C. *J. Chem. Soc.* 6250-6252 (1965).
 463 Boyle, R.E. *J. Org. Chem.* 31, 3880-3882 (1966).
 464 Roberts, D.D. *J. Org. Chem.* 31, 4037-4041 (1966).
 467 Michelot, R.; Tchoubar, B. *Bull. Soc. Chem. France* 3039-3040 (1966).
 469 Russell, G.A.; Janzen, E.G.; Becker, H-D.; Smentowski, F.J. *J. Am. Chem. Soc.* 84, 2652-2653 (1962).
 470 Gorvin, J.H. *Chem. Ind.* 1525-1526 (1967).
 471 Miller, J.; Parker, A.J. *J. Am. Chem. Soc.* 83, 117-123 (1961).
 472 Fuchs, R.; McCrary, G.E.; Bloomfield, J.J. *J. Am. Chem. Soc.* 83, 4281-4284 (1961).
 473 Ham, G.E. U.S. 3,206,499 (C1. 260-465.9) (Sept. 14, 1965).
 474 Freure, B.T.; Decker, H.J. U.S. 3,024,266 (C1. 260-464) (Mar. 6, 1962).
 475 Friedman, L.; Shechter, H. *J. Org. Chem.* 25, 877-879 (1960).
 477 Bloomfield, J.J.; Fennessey, P.V. *Tetrahedron Lett.* No. 33, 2273-2276 (1964).
 479 Anonymous *Chem. & Engr. News* 50-51 (Sept. 24, 1962).
 480 Webb, R.L. U.S. 3,264,362 (C1. 260-675.5) (Aug. 2, 1966).
 481 Price, C.C.; Snyder, W.H. *J. Am. Chem. Soc.* 83, 1773 (1961).
 486 Hardies, D.E.; Kornblum, N.; Powers, J.W. U.S. 3,014,972 (C1. 206-644) (Dec. 26, 1961).
 487 Fekete, F. U.S. 2,830,078 (C1. 260-486) (Apr. 8, 1958).
 489 Oesterling, R.E. U.S. 3,006,964 (C1. 260-608) (Oct. 31, 1961).
 490 Chang, R.C.; Wood, N.F. *Tetrahedron Lett.* No. 40, 2962-2973 (1964).
 491 Snyder, C.H.; Soto, A.R. *J. Org. Chem.* 29, 742-745 (1964).
 495 Cram, D.J.; Sahyun, M.R.V.; Knox, G.R. *J. Am. Chem. Soc.* 84, 1734-1735 (1962).
 496 Mac, Y.C.; Parker, A.J. *Australian J. Chem.* 19, 517-520 (1966).
 501 Hofmann, J.E.; Wallace, T.J.; Argabright, P.A.; Schriesheim, A. *Chem. & Ind. (London)* 1243-1244 (1963).
 514 Cram, D.J.; Day, A.C. *J. Org. Chem.* 31, 1227-1232 (1966).

515 Overberger, C.G.; Kurtz, T. *J. Org. Chem.* 31, 288-291 (1966).
517 Miller, B.; Margulies, H. *J. Org. Chem.* 30, 3895-3897 (1965).
524 Cram, D.J.; Gosser, L. *J. Am. Chem. Soc.* 86, 5457-5465 (1964).
526 Stewart, R.; O'Donnell, J.P. *Can. J. Chem.* 42, 1681-1693 (1964).
538 Bernasconi, C.F.; Kaufmann, M.; Zollinger, H. *Helv. Chem. Acta.* 49, 2563-2570 (1966).
540 Burdon, M.G.; Moffatt, J.G. *J. Am. Chem. Soc.* 88, 5855-5864 (1966).
541 Bacon, R.G.R.; Hill, H.A.O. *Proc. Chem. Soc.* 113-114 (1962).
544 Blumenthal, J.H. U.S. 3,028,423 (C1. 260-533) (Apr. 3, 1962).
550 Cisney, M.E. Crown Zellerbach, unpublished results (Jan. 12, 1967).
553 Kolthoff, I.M.; Reddy, T.B. *J. Electrochem. Soc.* 108, 980-985 (1961).
568 Russell, G.A.; Moye, A.J.; Janzen, E.G.; Mak, S.; Talaty, E.R. *J. Org. Chem.* 32, 137-146 (1967).
574 Ayres, J.T.; Mann, C.K. *Polymer Letters* 3, 505-508 (1965).
577 Smiley, R.A.; Arnold, C. *J. Org. Chem.* 25, 257-258 (1960).
578 Sahyun, M.R.V.; Cram, D.J. *J. Am. Chem. Soc.* 85, 1263-1268 (1963).
579 Schriesheim, A.; Hofmann, J.E.; Rowe, C.A., Jr. *J. Am. Chem. Soc.* 83, 3731-3732 (1961).
580 Snyder, C.H.; Soto, A.R. *J. Org. Chem.* 30, 673-676 (1965).
581 LeBel, R.g.; Goring, D.A.I. *J. Chem. Engr. Data* 7, 100-101 (1962).
585 Tommila, E.; Hamalainen, L. *Acta. Chem. Scand.* 17, 1985-1990 (1963).
589 Terrell, R.C.; Ucciardi, T.; Vitcha, J.F. *J. Org. Chem.* 30, 4011-4013 (1965).
592 Wood, N.F.; Chang, F.C. *J. Org. Chem.* 30, 2054-2055 (1965).
595 Bordwell, F.G.; Pitt, B.M. *J. Am. Chem. Soc.* 77, 572-577 (1955).
596 Bottini, A.T.; Schear, W. *J. Org. Chem.* 30, 3205-3206 (1965).
599 Bloomfield, J.J. *J. Org. Chem.* 26, 4112-4115 (1961).
600 Bottini, A.T.; Mullikin, J.A.; Morris, C.J. *J. Org. Chem.* 29, 373-379 (1964).
604 Clark, L.W. *J. Phys. Chem.* 61, 699-701 (1957).
606 Cram, D.J.; Kingsbury, C.A.; Rickborn, B. *J. Am. Chem. Soc.* 83, 3688-3696 (1961).
611 Zaugg, H.E.; Horrom, B.W.; Borgwardt, S. *J. Am. Chem. Soc.* 82, 2895-2903 (1960).
612 Zaugg, H.E. *J. Am. Chem. Soc.* 83, 837-840 (1961).
613 Zaugg, H.E.; Chadde, F.E.; Michaels, R.J. *J. Am. Chem. Soc.* 84, 4567-4573 (1962).
615 Zitko, V.; Bishop, C.T. *Can. J. Chem.* 44, 1749-1756 (1966).
622 Cram, D.J.; Gosser, L. *J. Am. Chem. Soc.* 85, 3890-3891 (1963).
624 Cotton, F.A.; Francis, R.; Horrocks, W.D., Jr. *J. Phys. Chem.* 64, 1534-1536 (1960).
631 Cram, D.J.; Wingrove, A.S. *J. Am. Chem. Soc.* 85, 1100-1107 (1963).
632 Corey, E.J.; Chaykovsky, M. *J. Am. Chem. Soc.* 87, 1353-1364 (1965).
634 Corey, E.J.; Chaykovsky, M. *J. Am. Chem. Soc.* 87, 1345-1353 (1965).
639 Martin, D.; Niclas, H-J. *Ber.* 102, 31-37 (1969).
640 Clark, L.W. *J. Phys. Chem.* 60, 825-826 (1956).
643 Clark, L.W. *J. Phys. Chem.* 65, 1651-1652 (1961).
650 Elias, H.; Christ, O.; Rosenbaum, E. *Ber.* 98, 2725-2737 (1965).
651 Elias, H.; Lieser, K.H. *Chem. Ber.* 94, 3128-3134 (1961).
652 Eaton, P.E. *J. Am. Chem. Soc.* 84, 2344-2348 (1962).
653 Eades, E.D.M.; Ball, D.H.; Long, L., Jr. *J. Org. Chem.* 31, 1159-1162 (1966).
656 Fuchs, R.; Nisbet, A. *J. Am. Chem. Soc.* 81, 2371-2373 (1959).
664 Gundermann, K.D. *Angew. Chem. Int. Ed.* 3, 144 (1964).
669 Heininger, S.A.; Dazzi, J. *Chem. Eng. News* 35, No. 9, 87 (1957).
672 Hofman, J.E.; Wallace, T.J.; Schriesheim, A. *J. Am. Chem. Soc.* 86, 1561-1563 (1964).
680 Jaunin, R. *Helv. Chim. Acta.* 49, 412-419 (1966).
682 Kornblum, N.; Powers, J.W. U.S. 2,816,909 (C1. 260-478) (Dec. 17, 1957).
684 Kornblum, N.; Blackwood, R.K.; Powers, J.W. *J. Am. Chem. Soc.* 79, 2507-2509 (1957).
685 Kornblum, N.; Powers, J.W. *J. Org. Chem.* 22, 455-456 (1957).
690 Kornblum, N.; Seltzer, R.; Haberfield, P. *J. Am. Chem. Soc.* 85, 1148-1154 (1963).
691 Kornblum, N.; Blackwood, R.K. *Organic Synthesis Coll. Vol. IV*, Rabjohn, N.Ed., John Wiley & Son, New York (1963), 454-456.
696 Ledwith, A.; Shih-Lin, Y. *Chem. & Ind.* 1867-1868 (1964).
705 Dalton, D.R.; Hendrickson, J.B.; Jones, D. *Chem. Comm.* 591-592 (1966).
712 Montgomery, J.A.; Temple, C., Jr. *J. Am. Chem. Soc.* 83, 630-635 (1961).
714 Neidlein, R.; Hausmann, W. *Angew. Chem. Int. Ed.* 4, 708-709 (1965).
720 Richtzenhain, H.; Alfredsson, B. *Ber.* 86, 142-148 (1953).
722 Russell, G.A.; Janzen, E.G.; Strom, E.T. *J. Am. Chem. Soc.* 84, 4155-4157 (1962).

725 Roberts, W.; Whiting, M.C. *J. Chem. Soc.* 1290-1293 (1965).

726 Roberts, D.D. *J. Org. Chem.* 30, 3516-3520 (1965).

728 Russell, G.A.; Janzen, E.G.; Bemix, A.G.; Geels, E.J.; Moye, A.J.; Mak, S.; Strom, E.T. *Advances in Chem. Series, No. 51*, 112-173 (1965).

730 Roberts, D.D. *J. Org. Chem.* 29, 2039-2040 (1964).

734 Steiner, E.C.; Gilbert, J.M. *J. Am. Chem. Soc.* 85, 3054-3055 (1963).

737 Sato, T.; Yamada, E-I.; Akiyama, T.; Inoue, H.; Hata, K. *Bull. Chem. Soc. Japan* 38, 1225 (1965).

742 Wolford, R.K. *J. Phys. Chem.* 68, 3392-3398 (1964).

772 Jones, J.L.; Fritsche, H.A., Jr. *J. Electroanal. Chem.* 12, 334-340 (1966).

773 LeNoble, W.J.; Puerta, J.E. *Tetrahedron Lett. No. 10*, 1087-1090 (1966).

786 Bowden, K.; Buckley, A.; Stewart, R. *J. Am. Chem. Soc.* 88, 947-949 (1966).

790 Allen, F.M. Crown Zellerbach, results unpublished (Jan. 20, 1965).

794 Allen, F.M. Crown Zellerbach, results unpublished (Aug. 12, 1960).

801 Dodd, R.E.; Gasser, R.P.H. *Proceed. Chem. Soc.* 415 (1964).

825 Maggiolo, A.; Blair, E.A. *Advances in Chem. Series, No. 21*, 200-201 (1959).

833 Cockerill, A.F.; Rottschaefer, S.; Saunders, W.H. *J. Am. Chem. Soc.* 89, 901-905 (1967).

843 Graham, W.H. *J. Am. Chem. Soc.* 87, 4396-4397 (1965).

849 Hayashi, Y.; Oda, R. *J. Org. Chem.* 32, 457-458 (1967).

872 Brett, D.; Downie, I.M.; Lee, J.B. *J. Org. Chem.* 32, 855-856 (1967).

882 Froemsdorf, D.H.; Robbins, M.D. *J. Am. Chem. Soc.* 89, 1737-1739 (1967).

884 Miller, B. *J. Am. Chem. Soc.* 89, 1685-1690 (1967).

885 Miller, B.; Margulies, H. *J. Am. Chem. Soc.* 89, 1678-84 (1967).

888 Manhas, M.S.; Jeng, S.J. *J. Org. Chem.* 32, 1246-1248 (1967).

905 DiSanto, C. U.S. 3,304,331 (C1. 260-607) (Feb. 14, 1967).

913 Bockmann, T.; Haanaes, E.; Ugelstad, J. *Tidsskr. Kjemi. Bergv. Met.* 24, No. 11, 209-215 (1964).

923 Wada, G.; Reynolds, W. *Inorg. Chem.* 5, 1354-1358 (1966).

941 Montgomery, J.A.; Thomas, H.J. *J. Org. Chem.* 30, 3235-3236 (1965).

942 Krapcho, A.P.; Glynn, G.A.; Grenon, B.J. *Tetrahedron Lett. No. 3*, 215-217 (1967).

944 Stewart, R.; O'Donnell, J.P.; Cram, D.J.; Rickborn, B. *Tetrahedron* 18, 917-922 (1962).

945 Bennett, C.F. Crown Zellerbach, results unpublished (Feb. 21, 1967).

947 Bennett, C.F. Crown Zellerbach, results unpublished (Aug. 16, 1966).

964 Cisney, M.E. Crown Zellerbach, results unpublished (Mar. 20, 1967).

965 Chang, F.C.; Wood, N. *Steroids* 5, 55-56 (1964).

982 Glynn, E. *Analyst* 72, 248-250 (1947).

988 Cisney, M.E. Crown Zellerbach, results unpublished (Mar. 8, 1967).

1001 Carson, J.F.; Boggs, L.E. *J. Org. Chem.* 31, 2862-2864 (1966).

1005 Gunther, W.H.H. *J. Org. Chem.* 31, 1202-1205 (1966).

1007 Boulton, A.J.; Ghosh, P.B.; Katritzky, A.R. *J. Chem. Soc. (C)* 971-976 (1966).

1016 Senning, A. *Chem. Commun.* 64 (1967).

1022 Brown, H.C.; Yoon, N.M. *J. Am. Chem. Soc.* 88, 1464-1472 (1966).

1024 Brown, H.C.; Weissman, P.M.; Yoon, N.M. *J. Am. Chem. Soc.* 88, 1458-1463 (1966).

1025 Sugiyama, N.; Akutagawa, M. *Bull. Chem. Soc. Japan* 40, 240 (1967).

1027 Cason, J.; Correia, J.S. *J. Org. Chem.* 26, 3645-3649 (1961).

1028 Tommila, E.; Virtanen, O. *Suomen Kemistilehti* 34B, 139-143 (1961).

1036 Manashi, J.; Reynolds, W.L.; Van Auken, G. *Inorg. Chem.* 4, 299-304 (1965).

1040 Oda, R.; Mieno, M.; Hayashi, Y. *Tetrahedron Lett. No. 25*, 2363-2365 (1967).

1055 Pettit, G.R.; Brown, T.H. *Can. J. Chem.* 45, 1306-1308 (1967).

1099 Wesslen, B. *Acta. Chem. Scand.* 21, 713-717 (1967).

1100 Wesslen, B. *Acta. Chem. Scand.* 21, 718-20 (1967).

1110 Chalmers, L. *Specialties* 2-6 (Dec. 1966).

1114 Rhoads, S.J.; Hasbrouck, R.W. *Tetrahedron* 22, 3557-3570 (1966).

1118 Sato, T.; Inoue, H.; Hata, K. *Bull. Chem. Soc. Japan* 40, 1502-1506 (1967).

1119 Ball, D.H.; Eades, E.D.M.; Long, L., Jr. *J. Am. Chem. Soc.* 86, 3579-3580 (1964).

1127 Albright, J.D.; Goldman, L. *J. Am. Chem. Soc.* 89, 2416-2423 (1967).

1138 Brown, H.C.; Rao, B.C.S. *J. Am. Chem. Soc.* 82, 681-686 (1960).

1140 Barton, D.H.R.; Jones, D.W. *J. Chem. Soc.* 3563-3570 (1965).

1161 Courtalds, Ltd. *Brit. Pat.* 928,114 (CO8F) (June 6, 1963).

1162 Cram, D.J.; Mateos, J.L.; Hauck, F.; Langmann, A.; Kopecky, K.R.; Nielsen, W.D.; Allinger,

- J. J. Am. Chem. Soc. 81, 5774-5784 (1959).
- 1172 Dolman, D.; Ross, S. *Can. J. Chem.* 45, 911-927 (1967).
- 1214 Kolling, O.W. *Trans. Kansas Acad. Sci.* 67(4), 635-639 (1964).
- 1229 Bram, G. *Tetrahedron Lett.* 41, 4069-4072 (1967).
- 1233 Nelsen, S.F.; Seppanen, E.D. *J. Am. Chem. Soc.* 89, 5740-5742 (1967).
- 1234 Burdon, M.G.; Moffatt, J.G. *J. Am. Chem. Soc.* 89, 4725-4735 (1967).
- 1237 Kornblum, N.; Davies, T.M.; Earl, G.; Greene, G.S.; Holy, N.L.; Kerber, R.C.; Manthey, J.W.; Musser, M.T.; Snow, D.H. *J. Am. Chem. Soc.* 89, 5714-5715 (1967).
- 1238 Calligaris, M.; Illuminati, G.; Marino, G. *J. Am. Chem. Soc.* 89, 3518-3521 (1967).
- 1239 Genel, F.; Illuminati, G.; Marino, G. *J. Am. Chem. Soc.* 89, 3516-3518 (1967).
- 1240 Illuminati, G.; Marino, G.; Sleiter, G. *J. Am. Chem. Soc.* 89, 3510-3515 (1967).
- 1257 Howards of Ilford, Ltd. *Brit. Pat.* 872,293 (Aug. 3, 1956).
- 1262 Ross, S.D.; Barry, J.E.; Petersen, R.C. *J. Am. Chem. Soc.* 83, 2133-2136 (1961).
- 1268 Hirose, K.; Ukai, S. *Yakugaku Zasshi* 86(3), 187-191 (1966); *CA* 64 19466D (1966).
- 1271 Kitagawa, H. *Kobunshi Kagaku* 20 (213), 5-10 (1963); *CA* 61 1942E (1964).
- 1273 Bennett, C.F.; Goheen, D.W.; MacGregor, W.S. *J. Org. Chem.* 28, 2845-2846 (1963).
- 1360 Nicholas, L.; Gmitter, G.T. *J. Cellular Plastics* 1 (1), 85-89 (1965).
- 1373 Wallace, T.J.; Mahon, J.J. *J. Am. Chem. Soc.* 86, 4099-4103 (1964).
- 1383 Ray, S.K.; Shaw, R.; Smith, B.C. *Nature* 196, 372 (1962).
- 1417 Sears, P.G.; Siegfried, W.D.; Sands, D.E. *J. Chem. Eng. Data* 9(2), 261-263 (1964).
- 1455 Shell Res. Ltd. *Fr. Pat.* 1,326,419 (C1. C O7C) (May 10, 1963).
- 1474 Whitstler, R.L.; King, A.H.; Ruffini, G.; Lucas, F.A. *Arch. Biochem. Biophys.* 121, 358-363 (1967).
- 1501 Cram, D.J.; Rickborn, B.; Kingsbury, C.A.; Haberfield, P. *J. Am. Chem. Soc.* 83, 3678-3687 (1961).
- 1503 Epstein, W.W.; Sweat, F.W. *Chem. Rev.* 67(3), 247-260 (1967).
- 1505 Evans, J.C.; Lo G. Y-S. *Spectrochimica Acta* 21, 33-44 (1965).
- 1508 Giordano, M.C.; Bazan, J.C.; Arvia, A.J. *Electrochim. Acta.* 11, 741-747 (1966).
- 1515 Horner, L.; Bruggemann, H. *Ann. Chem.* 635, 22-30 (1960), *CA*55 4401 (1961).
- 1521 Gallais, F.; Voigt, D. *Bull. Soc. Chim. France* 1935-1942 (1963).
- 1544 Landini, D.; Montanari, F. *Tetrahedron Lett.* 38, 2691-2696 (1964).
- 1558 Ritchie, C.D.; Uschold, R.E. *J. Am. Chem. Soc.* 89(12), 2960-2963 (1967).
- 1579 Tien, J.M.; Hunsberger, I.M. *U.S. Dept. Com. Tech. Serv.* AD264, 111 (1959).
- 1591 Feit, B-A.; Sinnreich, J.; Zilkha, A. *J. Org. Chem.* 32, 2570-2575 (1967).
- 1593 Bacon, R.G.R.; Hill, H.A.O. *J. Chem. Soc.* 1097-1107 (1964).
- 1612 Krull, L.H.; Friedman, J. *J. Chromatog.* 26, 336-338 (1967).
- 1638 Suhr, H. *Ann. Chem.* 687, 175-182 (1965); *CA* 63 17825C (1965).
- 1638 Suhr, H. *Ann. Chem.* 689, 109-117 (1965).
- 1651 Shilling, W.L. *Crown Zellerbach*, results unpublished.
- 1668 White, E.H.; Bursley, M.M. *J. Am. Chem. Soc.* 86, 941-942 (1964).
- 1687 Allenmark, S. *Ark. Kemi.* 24(4), 34-47 (1966).
- 1694 Venkatasubramanian, N.; Rao, G.V. *Tetrahedron Lett.* (52), 5275-5280 (1967).
- 1711 Ten Haken, P. *Tetrahedron Lett.* (8), 759-760 (1967).
- 1721 Hayashi, E.; Akahori, Y.; Watanabe, T. *J. Pharmaceutical Soc. Jap.* 87(9), 1115-1117 (1967).
- 1728 Martin, D.; Niclas, H.-J. *Ber.* 100, 187-195 (1967).
- 1744 Nichols, G.A. *Appita* 19(3), XXVII-XXX (1965); *ABIPC* 36, 8842.
- 1749 Porter, J.A. *AEC Res. & Dev. Report* DP-389 (July 1959).
- 1752 Parikh, J.R. *J. Am. Chem. Soc.* 89(21), 5505-5507 (1967).
- 1758 Brauman, J.I.; Nelson, N.J.; Kahl, D.C. *J. Am. Chem. Soc.* 90 (2), 490-491 (1968).
- 1759 Brauman, J.I.; Nelson, N.J. *J. Am. Chem. Soc.* 90 (2), 491-492 (1968).
- 1774 Zimmerman, H.E.; Grunewald, J.O. *J. Am. Chem. Soc.* 89, 5163-5172 (1967).
- 1787 Russell, G.A.; McDonnell, J.; Whittle, P.R. *J. Am. Chem. Soc.* 89, 5516-5517 (1967).
- 1798 Oth, J.F.M.; Merenyi, R.; Nielsen, J.; Schroder, G. *Ber.* 98, 3385-3400 (1965).
- 1805 Allenmark, S. *Acta. Chem. Scand.* 20, 910-911 (1966).
- 1823 Pond, D.M.; Cargill, R.L. *J. Org. Chem.* 32, 4064-4065 (1967).
- 1826 Peterson, P.E.; Bopp, R.J.; Chevli, D.M.; Curran, E.L.; Dillard, D.E.; Kamat, R.J. *J. Am. Chem. Soc.* 89, 5902-5911 (1967).
- 1880 Lyman, D.J. *U.S.* 2,984,636 (C1. 260-30.8) (May 16, 1961).
- 1924 Cisney, M.E. *Crown Zellerbach*, unpublished results (Feb. 13, 1967).

1942 Szmant, H.H. *Angew. Chem. Int. Ed.* 7(2), 120-128 (1968).
 1946 Harriss, H.E.; Herzog, H.L. U.S. 3,259,646 (C1. 260-465) (July 5, 1966).
 2007 Kollmeyer, W.D.; Cram, D.J. *J. Am. Chem. Soc.* 90, 1784-1791 (1968).
 2013 Firestone, R.A.; Reinhold, D.F.; Gaines, W.A.; Chemerda, J.M.; Sletzing, M. *J. Org. Chem.* 33, 1213-1218 (1968).
 2035 Cram, D.J.; Ratajczak, A. *J. Am. Chem. Soc.* 2198-2200 (1968).
 2075 Farbenfabriken Bayer A.-G. Ger. Pat. 1,088,980 (C1. CO7C) (Sept. 15, 1960).
 2125 Abramovitch, R.A.; Helmer, F.; Liveris, M. *J. Chem. Soc.* 492-496 (1968).
 2140 Sugiyama, N.; Akutagaawa, M.; Yamamoto, H. *Bull. Chem. Soc. Japan* 41, 936-941 (1968).
 2151 Garnsey, R.; Prue, J.E. *Trans. Faraday Soc.* 64(545), 1206-1219 (1968).
 2189 Dear, R.E.A.; Pattison, F.L.M. *J. Am. Chem. Soc.* 85, 622-626 (1963).
 2194 Delhoste, J.; Gomez, G.; Lamaty, G. *Comptes Rendus* 266(19), 1468-1470 (1968).
 2196 Dahlgren, K.; Delhoste, J.; Lamaty, G. *Comptes Rendus* 266(15), 1180-1182 (1968).
 2218 Berger, A.W.; Driscoll, J.S.; Pirog, J.A.; Linschitz, H. *Photochem. Photobio.* 7, 415-420 (1968).
 2223 Tommila, E.; Pajunen, A. *Suomen Kemi* 41(5-6), 172-175 (1968).
 2239 Normant, H. U. S. 3,390,186 (C1. 260-590) (June 25, 1968).
 2265 Kawai, W. *J. Polym. Sci. A-1* 6, 1945-1954 (1968).
 2323 Shapiro, E.; Legatt, T.; Weber, L.; Oliveto, E.P.; Tanake, M.; Crowe, D.F. *Steroids* 3, 183-188 (1964).
 2327 Onodera, K.; Hirano, S.; Kashimura, N. *Carbohydrate Res.* 6, 276-285 (1968).
 2343 Jurch, G.R., Jr.; Ramey, K.C. *Chem. Comm.* 1211-1212 (1968).
 2371 Haenni, E.O.; Joe, F.L., Jr.; Howard, J.W.; Leibel, R.L. *J. Assn. Off. Agr. Chemists* 45(1), 59-66 (1962).
 2463 McCasland, G.E.; Naumann, M.O.; Durham, L.J. *J. Org. Chem.* 33, 4220-4226 (1968).
 2492 Kreevoy, M.M.; Williams, J.M., Jr. *J. Am. Chem. Soc.* 90, 6809-6813 (1968).
 2520 Handley, T.H.; Cooper, J.H. *Anal. Chem.* 41(2), 381-382 (1969).
 2525 Schmid, G.H.; Fitzgerald, P.H. *Can. J. Chem.* 46, 3758-3762 (1968).
 2532 Goethals, E.J.; Sillis, C. *Makromol. Chemie* 119, 249-251 (1968).
 2565 Kornblum, N.; Davies, T.M.; Earl, G.W.; Holy, N.L.; Manthey, J.W.; Musser, M.T.; Swiger, R.T. *J. Am. Chem. Soc.* 90, 6219-6221 (1968).
 2566 Kornblum, N.; Earl, G.W.; Holy, N.L.; Manthey, J.W.; Musser, M.T.; Snow, D.H.; Swiger, R.T. *J. Am. Chem. Soc.* 90, 6221-6223 (1968).
 2567 Buchta, R.C.; Evans, D.H. *Anal. Chem.* 40(14), 2181-2186 (1968).
 2583 Kohler, W.; Neuheiser, L. *Z. Chem.* 8(11), 425-426 (1968).
 2589 Hoffman, T.D.; Cram, D.J. *J. Am. Chem. Soc.* 91, 1000-1008 (1969).
 2597 Gustav, J.; Schulz, D.; Whitaker, A.C.; Winteler, P. U.S. 3,418,360 (C1. 260-475) (Dec. 24, 1968).
 2643 Johnson, C.R.; Phillips, W.G. *J. Am. Chem. Soc.* 91, 682-687 (1969).
 2652 Cree, G.M.; Mackie, D.W.; Perlin, A.S. *Can. J. Chem.* 47, 511-512 (1969).
 2749 Milborrow, B.V.; Djerassi, C. *J. Chem. Soc. C* 417-424 (1969).
 2760 Brownlee, R.T.C.; English, P.J.Q.; Katritzky, A.R.; Topsom, R.D. *J. Phys. Chem.* 73, 557-564 (1969).
 2765 Buckley, A.; Chapman, N.B.; Shorter, J. *J. Chem. Soc. B* 195-200 (1969).
 2769 Landgrebe, J.A.; Thurman, D.E. *J. Am. Chem. Soc.* 91, 1759-1766 (1969).
 2779 Toland, W.G. U.S. 3,428,671 (C1. 260-51.3) (Feb. 18, 1969).
 2783 Anderson, A.G., Jr.; Breazeale, R.D. *J. Org. Chem.* 34(8), 2375-2384 (1969).
 2842 Baker, R.; Spillett, M.J. *J. Chem. Soc. B* 581-588 (1969).
 2887 Bonthron, W.; Cornforth, J.W. *J. Chem. Soc. C* 1202-1204 (1969).
 2896 Oae, S. *Quart. Reports on Sulfur Chemistry* 5(1), 53-66 (1970).
 2900 Clever, H.L.; Westrum, E.F., Jr. *J. Phys. Chem.* 74, (6), 1309-1317 (1970).
 2915 Clarke, T.G.; Hampson, N.A.; Lee, J.B.; Morley, J.R.; Scanlon, B. *Can. J. Chem.* 47, 1649-1654 (1969).
 2924 Smith, R.G.; Vanterpool, A.; Kulak, H.J. *Can. J. Chem.* 47, 2015-2019 (1969).
 2940 Morgan, M.S.; Simon, A.W. U.S. 3,441,574 (C1. 260-369) (Apr. 29, 1969).
 2969 Fierce, W.L. U.S. 3,461,156 (C1. 260-491) (Aug. 12, 1969).
 2980 Hutchins, R.O.; Hoke, D.; Keogh, J.; Koharski, D. *Tetrahedron Lett.* 40, 3495-3498 (1969).
 2987 Klein, J.; Brenner, S. *Chem. Comm.* 1020-1021 (1969).
 2988 Acharaya, S.P.; Brown, H.C.; Suzuki, A.; Nozawa, S.; Itoh, M. *J. Org. Chem.* 34(10), 3015-

- 3022 (1969).
- 3009 Baird, M.S.; Reese, C.B. *J. Chem. Soc. C* 1803-1807 (1969).
- 3033 Corey, E.J.; Weinshenker, N.M.; Schaaf, T.K.; Huber, W. *J. Am. Chem. Soc.* 91, 5675-5677 (1969).
- 3048 Kharasch, N.; Szmant, H.H. *Quart. Rep. Sulfur Chem.* 3(2), 147-148 (1968).
- 3049 Kharasch, N.; MacGregor, W.S. *Quart. Rep. Sulfur Chem.* 3(2), 149-158 (1968).
- 3112 Davies, J.S.; Cavies, V.H.; Hassall, C.H. *J. Chem. Soc. C* 1873-1879 (1969).
- 3142 Terrell, R.C. U.S. 3,476,812 (C1.260-609) (Nov. 4, 1969).
- 3148 Iriuchijima, S.; Tsuchihashi, G.-I. *Synthesis* 588 (1970).
- 3152 Beninate, J.V.; Boylston, E.K. U.S. 3,480,381 (C1. 8-120) (Nov. 25, 1969).
- 3178 Gibson, T.W.; Erman, W.F. *J. Am. Chem. Soc.* 91, 4771-4777 (1969).
- 3215 Bennett, C.F. Crown Zellerbach, results unpublished (Sept. 15, 1970).
- 3217 Tallant, D.R.; Evans, D.H. *Anal. Chem.* 41(6), 835-838 (1969).
- 3241 Schneider, H.W. *J. Chem. Ed.* 47, 519-522 (1970).
- 3247 Whitaker, K.E.; Snyder, H.R. *J. Org. Chem.* 35, 30-32 (1970).
- 3248 Bell, H.M.; Vanderslice, C.W.; Spehar, A. *J. Org. Chem.* 34, 3923-3926 (1969).
- 3249 Feit, B.A.; Bigon, Z. *J. Org. Chem.* 34, 3942-3948 (1969).
- 3272 Irvine, D.S.; Kruger, G. *J. Org. Chem.* 35, 2418-2419 (1970).
- 3356 Blakrishnan, M.; Rao, G.V.; Venkatasubramian, N. *Indian J. Chem.* 8, 566-567 (1970).
- 3360 Weiss, R.G.; Snyder, E.I. *J. Org. Chem.* 35, 1627-1632 (1970).
- 3368 Bartsch, R.A. *J. Org. Chem.* 35, 1334-1338 (1970).
- 3376 Filler, R.; Rao, Y.S.; Biezais, A.; Miller, F.N.; Beaucaire, V.D. *J. Org. Chem.* 35, 930-935 (1970).
- 3384 Stalick, W.M.; Rines, H. *J. Org. Chem.* 35, 422-426 (1970).
- 3386 Chow, S.W.; Pilato, L.A.; Wheelwright, W.L. *J. Org. Chem.* 35, 20-22 (1970).
- 3387 Heindel, N.D.; Kennewel, P.D. *J. Org. Chem.* 35, 80-83 (1970).
- 3395 Cruickshank, P.A.; Fishman, M. *J. Org. Chem.* 34, 4060-4065 (1969).
- 3398 Bartsch, R.A.; Cook, D.M. *J. Org. Chem.* 35, 1714-1715 (1970).
- 3399 Klabunde, K.J.; Burton, D.J. *J. Org. Chem.* 35, 1711-1712 (1970).
- 3429 Brown, H.C.; Heim, P.; Yoon, N.M. *J. Am. Chem. Soc.* 92, 1637-1646 (1970).
- 3433 Kornblum, N.; Stuchal, F.W. *J. Am. Chem. Soc.* 92, 1804-1806 (1970).
- 3445 Orvik, J.A.; Bunnett, J.F. *J. Am. Chem. Soc.* 92, 2417-2427 (1970).
- 3447 Kemp, D.S.; Paul, K. *J. Am. Chem. Soc.* 92, 2553-2554 (1970).
- 3456 Woerner, F.P.; Reimlinger, H. *Ber.* 103, 1908-1917 (1970).
- 3481 Sucrow, W.; Girgensohn, B. *Ber.* 103, 750-756 (1970).
- 3482 Roth, W.R.; Koenig, J.; Stein, K. *Ber.* 103, 426-439 (1970).
- 3490 Kornblum, N.; Swiger, R.T.; Earl, G.W.; Pinnick, H.W.; Stuchal, F.W. *J. Am. Chem. Soc.* 92, 5513-5514 (1970).
- 3503 Kelsey, D.R.; Bergman, R.G. *J. Am. Chem. Soc.* 92, 228-230 (1970).
- 3506 Bottaccio, G.; Chiusoli, G.P. *Z. Naturforsch. (B)* 23, 1016 (1968); *Synthesis* 1,33 (1970).
- 3519 Jacobus, J. *J. Chem. Soc. (D)* 338-339 (1970).
- 3572 Yamatani, T.; Yasunami, M.; Takase, K. *Tetrahedron Lett.* 1725-1728 (1970).
- 3584 Fahey, R.C.; Monahan, M.W. *J. Am. Chem. Soc.* 92, 2816-2820 (1970).
- 3602 Butterworth, R.F.; Hanessian, S. *Synthesis* 70-88 (1971).
- 3631 Miller, B. *J. Org. Chem.* 35, 4262-4264 (1970).
- 3653 Happ, J.W.; Janzen, E.G.; Rudy, B.C. *J. Org. Chem.* 35, 3382-3389 (1970).
- 3660 Truce, W.E.; Markley, L.D. *J. Org. Chem.* 35, 3275-3281 (1970).
- 3662 Rabjohn, N.; Harbert, C.A. *J. Org. Chem.* 35, 3240-3243 (1970).
- 3686 Baer, H.H.; Naik, S.R. *J. Org. Chem.* 35, 3161-3164 (1970).
- 3707 Reese, C.B.; Shaw, A. *J. Chem. Soc. (D)* 1172-1173 (1970).
- 3721 Lorkowski, H.J.; Pannier, R. *J. Prakt. Chem.* 311, 936 (1969).
- 3743 Dodd, D.; Johnson, M.D. *J. Chem. Soc. (B)*, 1337-1343 (1970).
- 3766 Raber, D.J.; Bingham, R.c.; Harris, J.M.; Fry, J.L.; Schleyer, P.V.R. *J. Am. Chem. Soc.* 92, 5977-5981 (1970).
- 3816 Brown, H.C.; Bigley, D.B.; Arora, S.K.; Yoon, N.M. *J. Am. Chem. Soc.* 92, 7161-7167 (1970).
- 3820 Pollack, R.M.; Bender, M.L. *J. Am. Chem. Soc.* 92, 7190-7194 (1970).
- 3827 Farr, F.R.; Bauld, N.L. *J. Am. Chem. Soc.* 92, 6695-6696 (1970).
- 3830 Miller, B. *J. Am. Chem. Soc.* 92, 6252-6259 (1970).
- 3853 Bartsch, R.A.; Kelly, C.F.; Pruss, G.M. *Tetrahedron Lett.* 3795-3796 (1970).

- 3875 Franck, B.; Petersen, U.; Hueper, F. *Angew. Chem. Intern. Ed. Engl.* 9, 891 (1970).
- 3885 Reimlinger, H. *Ber.* 103, 3278-3283 (1970).
- 3920 Bennett, C.F. Crown Zellerbach; results unpublished (Aug. 8, 1969).
- 3921 Bennett, C.F. Crown Zellerbach; results unpublished (Nov. 20, 1970).
- 3922 Bennett, C.F. Crown Zellerbach; results unpublished (Nov. 12, 1968).
- 3925 Tuemmler, W.B.; Linder, S.M. U.S. 3,506,724 (C1. 260-622) (Apr. 14, 1970).
- 3931 Orle, J.V. Crown Zellerbach; results unpublished (Jan. 14, 1969).
- 3951 Taranko, L.B.; Perry, R.H., Jr. *J. Org. Chem.* 34, 226-227 (1969).
- 4018 Birch, A.J.; Hutchinson, E.G.; Rao, G.S. *J. Chem. Soc. (C)* 637-642 (1971).
- 4026 Dalton, D.R.; Dutta, V.P. *J. Chem. Soc. (B)* 85-89 (1971).
- 4037 Marshall, J.A.; Cohen, G.M. *J. Org. Chem.* 36, 877-882 (1971).
- 4046 Hutchins, R.O.; Lawson, D.W.; Rua, L.; Milewski, C.; Maryanoff, B. *J. Org. Chem.* 36, 803-806 (1971).
- 4048 Marshall, J.A.; Warne, T.M., Jr. *J. Org. Chem.* 36, 178-183 (1971).
- 4058 Hales, R.H.; Bradshaw, J.S.; Pratt, D.R. *J. Org. Chem.* 36, 314-317 (1971).
- 4059 Bradshaw, J.S.; Hales, R.H. *J. Org. Chem.* 36, 318-322 (1971).
- 4066 Weiss, R.G.; Snyder, E.I. *J. Org. Chem.* 36, 403-406 (1971).
- 4068 Baumann, J.B. *J. Org. Chem.* 36, 396-398 (1971).
- 4077 Farnum, D.G.; Mostashari, A.; Hagedorn, III, A.A. *J. Org. Chem.* 36, 698-702 (1971).
- 4093 Walters, S.L.; Bruice, T.C. *J. Am. Chem. Soc.* 93, 2269-2282 (1971).
- 4098 Stocks, I.D.H.; Waite, J.A.; Wooldridge, K.R.H. *J. Chem. Soc. (C)*, 1314-1317 (1971).
- 4110 Bhalerao, U.T.; Rapaport, H. *J. Am. Chem. Soc.* 93, 105-110 (1971).
- 4123 Jacobs, R.L. *J. Org. Chem.* 36, 242-243 (1971).
- 4126 Poutsma, M.L.; Ibarbia, P.A. *J. Am. Chem. Soc.* 93, 440-450 (1971).
- 4128 Venezky, D.L. *Anal. Chem.* 43, 971 (1971).
- 4136 Seree, De Roch, I.; Menguy, P. French Pat. 1,540,284 (C1. CO7C) (Sept. 27, 1968); CA 71, 80944Q.
- 4175 Sherrod, S.A.; Bergman, R.G. *J. Am. Chem. Soc.* 93, 1925-1940 (1971).
- 4176 Kelsey, D.R.; Bergman, R.G. *J. Am. Chem. Soc.* 93, 1941-1952 (1971).
- 4180 Parker, A.J. *Chem. Tech.* 297-303 (1971).
- 4235 Augustyn, O.P.H.; DeWet, P.; Garbers, C.F.; Lourens, L.C.F.; Neuland, E.; Schneider, D.F.; Steyn, K. *J. Chem. Soc. (C)* 1878-1884 (1971).
- 4249 Zefirov, N.S.; Chapovskaya, N.K. *J. Org. Chem. USSR* 4, 1252 (1968).
- 4257 Mantione, R. *Synthesis*, 332-333 (1971).
- 4258 Mantione, R. *Synthesis*, 332 (1971).
- 4261 Shepherd, T.M. *Chem. Ind.* 567 (1970); *Synthesis*, 334 (1971).
- 4262 Koester, R.; Arora, S.; Binger, P. *Synthesis*, 322-323 (1971).
- 4278 Shepard, K.L. *J. Chem. Soc. (D)*, 951-952 (1971).
- 4311 Kruger, G. *J. Org. Chem.* 36, 2129-2132 (1971).
- 4333 Cable, J.; Djerassi, C. *J. Am. Chem. Soc.* 93, 3905-3910 (1971).
- 4339 Pines, H.; Stalick, W.M.; Holford, T.G.; Golab, J.; Lazar, H.; Simonik, J. *J. Org. Chem.* 36, 2299-2301 (1971).
- 4349 Brimacombe, J.S. *Angew. Chem. Intern. Ed. Engl.* 10, 236-248 (1971).
- 4355 Isele, G.L.; Luttringhaus, A. *Synthesis*, 266-268 (1971).
- 4360 Muchowski, J.M. *Can. J. Chem.* 49, 2023-2028 (1971).
- 4382 Karady, S.; Ly, M.G.; Pines, S.H.; Slezinger, M. *J. Org. Chem.* 36, 1949-1951 (1971).
- 4384 McMurry, J.E.; Melton, J. *J. Am. Chem. Soc.* 93, 5309-5311 (1971).
- 4392 Hoffman, J.M., Jr.; Schlessinger, R.H. *J. Chem. Soc. (D)*, 1245-1246 (1971).
- 4425 Davies, J.H.; Haddock, E.; Kirby, P.; Webb, S.B. *J. Chem. Soc. (C)*, 2843-2846 (1971).
- 4436 Gullotti, M.; Ugo, R.; Colonna, S. *J. Chem. Soc. (C)*, 2652-2656 (1971).
- 4452 Zefirov, N.S.; Chapovskaya, N.K.; Kolesnikov, V.V. *J. Chem. Soc. (D)*, 1001-1002 (1971).
- 4467 Bowden, K.; Cook, R.S. *J. Chem. Soc. (B)*, 1765-1770 (1971).
- 4492 Fry, A.J.; Britton, W.E. *Tetrahedron Lett.* 46, 4363-4366 (1971).
- 4520 Bowden, K.; Cook, R.S. *J. Chem. Soc. (B)*, 1771-1778 (1971).
- 4521 Bowden, K.; Price, M.J. *J. Chem. Soc. (B)*, 1784-1792 (1971).
- 4523 Gilmer, T.C.; Pietrzyk, D.J. *Anal. Chem.* 43, 1585-1592 (1971).
- 4524 Ono, N. *Bull. Chem. Soc. Japan* 44, 1369-1372 (1971).
- 4562 Russell, G.A.; Norris, R.K.; Panek, E.J. *J. Am. Chem. Soc.* 93, 5839-5845 (1971).
- 4573 Dunn, B.M.; Bruice, T.C. *J. Am. Chem. Soc.* 93, 5725-5731 (1971).
- 4600 Boulton, A.J.; Ghosh, P.B.; Katritzky, A.R. *J. Chem. Soc. (B)*, 1004-1011 (1966).

- 4602 Chen, C.-T.; Yan, S.-J.; Wang, C.-H. *Chem. Ind. (London)* 895-896 (1970); CA 73, 55764Q.
- 4636 Claus, P.; Vavra, N.; Schilling, P. *Monatsh. Chem.* 102, 1072-1080 (1971).
- 4651 Lerch, U.; Moffatt, J.G. *J. Org. Chem.* 36, 3861-3869 (1971).
- 4653 Snyder, C.D.; Bondinell, W.E.; Rapoport, H. *J. Org. Chem.* 36, 3951-3960 (1971).
- 4669 McKinley, S.V.; Rakshys, J.W., Jr. *J. Chem. Soc. Chem. Commun.* 134-135 (1972).
- 4699 Heine, H.G. *Synthesis* 664 (1971).
- 4704 Johnson, R.N.; Farnham, A.G. *J. Polymer Sci. A-1*, 5, 2415-2427 (1967).
- 4739 Bullock, E.; Carter, R.A.; Gregory, B.; Shields, D.C. *J. Chem. Soc., Chem. Commun.* 97-98 (1972).
- 4748 Hammond, G.S.; Neuman, R.C., Jr. *J. Am. Chem. Soc.* 83, 1501-1508 (1963).
- 4755 Margaretha, P. *Tetrahedron Lett.* 4891-4892 (1971).
- 4767 Fomin, G.V.; Gurdzhiyan, L.N. *Zh. Fiz. Khim.* 44, 1820-1821 (1970); CA 73, 76458H.
- 4772 Doucet, J.; Gagnaire, D.; Robert, A. *Synthesis*, 556 (1971).
- 4775 Wharton, P.S.; Sundin, C.E.; Johnson, D.W.; Kluender, H.C. *J. Org. Chem.* 37, 34-38 (1972).
- 4776 Kingsbury, C.A. *J. Org. Chem.* 37, 102-106 (1972).
- 4792 Haszeldine, R.N.; Hewitson, B.; Higginbottom, B.; Rigby, R.B.; Tipping, A.E. *J. Chem. Soc., Chem. Commun.* 249-250 (1972).
- 4802 Martin, D.; Berger, A.; Peschel, R. *Synthesis*, 598 (1971).
- 4812 Bakke, J. *Acta. Chem. Scand.* 25, 3509-3516 (1971).
- 4815 Hortmann, A.G.; Roberston, D.A.; Gillard, B.K. *J. Org. Chem.* 37, 322-324 (1972).
- 4817 Dalton, D.R.; Rodebaugh, R.K.; Jefford, C.W. *J. Org. Chem.* 37, 362-367 (1972).
- 4820 Durst, T. *Advan. Org. Chem.* 6, 285-388 (1969); CA 72, 21221Z.
- 4846 Komatsu, Y.; Furukawa, Y.; Shima, K. *Japan.* 70,00,496 (C1. 16 B 41) (Jan. 1970); CA 72, 110777C.
- 4891 Olofson, R.A.; Marino, J.P. *Tetrahedron* 27, 4195-4208 (1971).
- 4892 Bohlmann, F.; Buhmann, U. *Ber.* 105, 863-873 (1972).
- 4898 Marino, J.P.; Pfitzner, K.E.; Olofson, R.A. *Tetrahedron* 27, 4181-4194 (1971).
- 4906 Liu, M.T.H.; Toriyama, K. *J. Phys. Chem.* 76, 797-801 (1972).
- 4907 Arad, Y.; Levy, M.; Miller, I.R.; Vofsi, D. *U.S. Patent* 3,649,666 (C1. 250-465.8) (Mar. 14, 1972).
- 4910 Jackisch, P.F. *U.S. Patent* 3,642,887 (C1. 260-534 E) (Feb. 15, 1972).
- 4920 zu Reckendorf, W.M.; kamprath-Scholtz, U. *Ber.* 105, 686-695 (1972).
- 4934 Bates, R.B.; Kroposki, L.M.p; Potter, D.E. *J. Org. Chem.* 37, 560-562 (1972).
- 4945 Friedman, M.; Krull, L.H. *Biochim. Biophys. Acta.* 207, 361-363 (1970); CA 73, 35746G.
- 4972 Tandara, M. *U.S. Patent* 3,655,748 (C1. 260-634 R) (Apr. 11, 1972).
- 4987 Rees, C.W.; Yelland, M. *J. Chem. Soc., Perkin I Trans.* 77-82 (1972).
- 5033 Kharasch, N.; Ranky, W.O.; Nelson, D.C. *Organic Sulfur Compounds. Dimethyl Sulfoxide, Vol. I. Symposium Publication Division. Pergamon Press, New York Oxford, London, Paris, 170-182 (1961).*
- 5038 Schmid, G.H.; Wolkoff, A.W. *Can. J. Chem.* 50, 1181-1186 (1972).
- 5116 Rapoport, E.; Cass, M.W.; White, E.H. *J. Am. Chem. Soc.* 94, 3153-3159 (1972).
- 5118 Tanner, D.D.; Van Bostelen, P. *J. Am. Chem. Soc.* 94, 3187-3195 (1972).
- 5124 Kamigata, N.; Kurihara, T.; Minato, H. *Bull. Chem. Soc. Japan* 44, 3152-3154 (1971).
- 5185 McLoughlin, V.C.R.; Thrower, J. *Synthesis*, 441 (1971).
- 5192 Bamford, C.H.; Ferrar, A.N. *Proc. Roy. Soc., Ser. A* 321, 425-443 (1971).
- 5244 Bradshaw, J.S.; Chen, E.Y.; Hales, R.H.; South, J.A. *J. Org. Chem.* 37, 2051-2052 (1972).
- 5279 Moyer, P.H.; Penner, S.E. *Ger. Offen.* 1,959,343 (C1. C O7 C) (Aug. 13, 1970); CA 73 98306X.
- 5296 Whistler, R.L.; BeMiller, J.N.; Onodera, K.; Kashimura, N. *Oxidation of Carbohydrates with Dimethyl Sulfoxide-Phosphorus Pentaoxide, Methods in Carbohydrate Chemistry, Vol. VI, Academic Press, New York and London (1972), p. 331-336.*
- 5300 Bravo, P.; Gaudiano, G.; Ponti, P.P. *Chem. Ind. (London)* 253-254 (1971); CA 74, 111854D.
- 5339 Chu, K.C.; Cramn, D.J. *J. Am. Chem. Soc.* 94, 3521-3531 (1972).
- 5435 Casey, J.P.; Martin, R.B. *J. AM. Chem. Soc.* 94, 6141-6151 (1972).
- 5459 Radhakrishnamurti, P.S.; Patro, P.C. *Indian J. Chem.* 9,1098-1101 (1971); CA 76, 13377X.
- 5481 zu Reckendorf, W.M.; Wassiliadou-Micheli, N. *Ber.* 105, 2998-3013 (1972).

- 5488 Morisaki, S.; Baba, N.; Tajima, S. *Denki Kagaku* 38, 746-752 (1970).
- 5526 Nazarova, N.M.; Freidlin, L.K.; Kopyttsev, Y.A.; Varava, T.I. *Isv. Akad. Nauk. SSSR, Ser. Khim.* 1422-1424 (1972); CA 77, 100943T.
- 5551 House, H.O. *Modern Synthetic Reactions*, 2nd Edition, W.A. Benjamin Inc., Menlo Park, 682-691 (1972).
- 5587 Haga, J.J.; Russell, B.R.; Chapel, J.F. *Biochem. Biophys. Res. Commun.* 44, 521-525 (1971); CA 75 86543N.
- 5594 Schoberth, W.; Hanack, M. *Synthesis*, 703 (1972).
- 5613 Benius, U.; Bergson, G. *Acta. Chem. Scand.* 26, 2546-2547 (1972).
- 5622 Balakrishnan, M.; Rao, G.V.; Venkatasubramanian, N. *Tetrahedron Lett.* 4617-4620 (1972).
- 5630 Freidlin, L.K.; Nazarova, N.M.; Kopyttsev, Y.A. *Izv. Akad. Nauk. SSSR, Ser. Khim.* 201-203 (1972); CA 77, 4634X.
- 5635 Liu, M.T.H.; Toriyama, K. *Can. J. Chem.* 50, 3009-3016 (1972).
- 5642 Gloor, B.; Kaul, B.L.; Zollinger, H. *Helv. Chim. Acta.* 55, 1596-1610 (1972).
- 5663 Rylander, P.N.; Karpenko, I.M.; Pond, G.R. U.S. 3,694,509 (C1. 260-578) (Sept. 26, 1972).
- 5800 David, Estienne, J. *Brit.* 1,219,599 (C1. C O7C 27/12, 45/34, 51/32) (Jan. 20, 1971).
- 5834 Belanger, A.; Brassard, P. *J. Chem. Soc. Chem. Commun.* 863-864 (1972).
- 5836 Johnston, D.B.R.; Schmitt, S.M.; Firestone, R.A.; Christensen, B.G. *Tetrahedron Lett.* 4917-4920 (1972).
- 5843 Capozzi, G.; Modena, G.; Ronzini, L. *J. Chem. Soc. Perkin Trans. I*, 1136-1139 (1972).
- 5846 Anderson, D.J.; Horwell, D.C.; Stanton, E.; Gilchrist, T.L.; Rees, C.W. *J. Chem. Soc. Perkin Trans. I*, 1317-1321 (1972).
- 5864 Bowden, K.; Cook, R.S. *J. Chem. Soc. Perkin Trans. II*, 1407-1411 (1972).
- 5912 Hofmeister, H.; Laurent, H.; Wiechert, R. *Ber.* 106, 723-726 (1973).
- 5969 Rao, G.V.; Venkatasubramanian, N. *Aust. J. Chem.* 24, 201-203 (1971).
- 5971 Buchta, R.C.; Evans, D.H. *J. Electrochem. Soc.* 117, 1492-1500 (1970).
- 5980 Norris, R.D.; Binsch, G. *J. Am. Chem. Soc.* 95, 182-190 (1973).
- 6026 Gould, R.F.; Schulze, S.R.; Baron, A.L. *Advances in Chemistry Series 91*, American Chemical Society, Washington, D.C. 692-702 (1969).
- 6028 Kruger, H.-R.; Weyerstahl, P.; Marschall, H.; Nerdel, F. *Ber.* 105, 3553-3565 (1972).
- 6079 Hirano, S.; Kashimura, N.; Kosaka, N.; Onodera, K. *Polymer* 13, 190-194 (1972); CA 77, 50489B.
- 6098 Jacobus, J. *J. Org. Chem.* 38, 402-404 (1973).
- 6102 Krapcho, A.P.; Lovey, A.J. *Tetrahedron Lett.* 957-960 (1973).
- 6163 Paquette, L.A.; Meisinger, R.H.; Wingard, R.E., Jr. *J. Am. Chem. Soc.* 95, 2230-2240 (1973).
- 6172 Stetter, H.; Schreckenber, M. *Tetrahedron Lett.* 1461-1462 (1973).
- 6192 Michelotti, F.W.; Jordan, J.M.; Cook, N.P. U.S. 3,728,400 (C1. 260-609A) (Apr. 17, 1973).
- 6215 Sato, K.; Inoue, S.; Ohashi, M. *Bull. Chem. Soc. Jap.* 1288-1290 (1973).
- 6234 Bartsch, R.A.; Pruss, G.M.; Bushaw, B.A.; Wiegers, K.E. *J. Am. Chem. Soc.* 95, 3405-3407 (1973).
- 6243 Bashir, N.; Gilchrist, T.L. *J. Chem. Soc. Perkin Trans. I*, 868-872 (1973).
- 6268 Iriuchijima, S.; Tsuchihashi, G. U.S. 3,732,318 (C1. 260-607) (May 8, 1973).
- 6287 Yankee, E.W.; Badea, F.D.; Howe, N.E.; Cram, D.J. *J. Am. Chem. Soc.* 95, 4210-4219 (1973).
- 6293 Poupko, R.; Rosenthal, I. *J. Phys. Chem.* 77, 1722-1724 (1973).
- 6315 Kabuto, K.; Kikuchi, Y.; Yamaguchi, S.; Inoue, N. *Bull. Chem. Soc. Japan* 46, 1839-1844 (1973).
- 6325 Cox, B.G.; Parker, A.J. *J. Am. Chem. Soc.* 95, 408-410 (1973).
- 6347 Marshall, J.A.; Faubl, H. *J. Am. Chem. Soc.* 92, 948-955 (1970).
- 6378 Bartsch, R.A.; Shelly, T.A. *J. Org. Chem.* 38, 2911-2913 (1973).
- 6398 DeJonge, C.R.H. I.; Hageman, H.J.; Huysmans, W.G.B.; Mijs, W.J. *J. Chem. Soc. Perkin Trans. II*, 1276-1279 (1973).
- 6460 Anderson, E.; Fife, T.H. *J. Am. Chem. Soc.* 95, 6437-6438 (1973).
- 6463 Hajos, Z.G.; Parrish, D.R. *J. Org. Chem.* 38, 3244-3249 (1973).
- 6474 Broxton, T.J.; Deady, L.W. *Tetrahedron Lett.* 3915-3918 (1973).
- 6477 Cleve, N.J. *Suom. Kemistilehti B* 45, 385-390 (1972).
- 6496 Ibne-Rasa, K.M.; Tahir, A.R.; Rahman, A. *Chem. Ind. (London)* 232 (1973).
- 6502 Barrow, K.D.; Barton, D.H.R.; Chain, E.; Ohnsorge, F.W.; Sharma, P. *J. Chem. Soc.*

Perkin Trans. I, 1590-1599 (1973).

6509 Gordon, J. E.; Chang, V. S. K. *J. Org. Chem.* 38, 3062-3064 (1972).

6510 Klein, J.; Gurfinkel, E. *Tetrahedron* 2127-2131 (1970); *Synthesis* 704 (1972).

6543 Findlay, J. A.; Kwan, D. *Can. J. Chem.* 51, 3299-3301 (1973).

6572 DiNunno, L.; Florio, S.; Todesco, P. E. *J. Chem. Soc. Perkin Trans. I*, 1954-1955 (1973).

6593 Coates, R. M.; Chung, S. K. *J. Org. Chem.* 38, 3740-3741 (1973).

6613 Pilgram, K. H.; Medema, D.; Soloway, S. B.; Gaertner, G. W. Jr. *U.S. Pat.* 3,775,485 (C1. 260-609 F) (Nov. 27, 1973).

6627 Ghera, E.; Perry, D. H.; Shoua, S. *J. Chem. Soc. Chem. Commun.* 858-859 (1973).

6648 Matcha, R. L. *J. Am. Chem. Soc.* 95, 7508-7510 (1973).

6659 Fry, A.J.; Britton, W. E. *J. Org. Chem.* 38, 4016-4021 (1973).

6671 Hooz, J.; Bridson, J. N. *J. Am. Chem. Soc.* 95, 602 (1973); *Synthesis* 685 (1973).

6672 Bharucha, N. R. *U.S. Pat.* 3,772,170 (C1. 204/51) (Nov. 13, 1973).

6674 Pilgram, K. H.; Medema, D.; Soloway, S. B.; Gaertner, G. W. Jr. *U.S. Pat.* 3,772,391 (C1. 260-609 F) (Nov. 13, 1973).

6691 Stevens, C. L.; Balasubramanian, K. K.; Bryant, C. P.; Filippi, J. B.; Pillai, P. M. *J. Org. Chem.* 38, 4311-4318 (1973).

6692 McMurry, J. E.; Melton, J. *J. Org. Chem.* 38, 4367-4373 (1973).

6713 Sakai, H.; Hamada, S.; Yamanaka, Y.; Ito, I.; Izumi, Z.; Kitagawa, H.; Mukoyama, E.; Suzuki, Z.; Kato, T.; Hosaka, S. *U.S. Pat.* 3,781,248 (C1. 260-793 M) (Dec. 25, 1973).

6785 Renaud, R. N. *Can. J. Chem.* 52, 376-380 (1974).

6815 Pearson, D. E.; Buehler, C. A. *Chem. Revs.* 74, 45-86 (1974).

6818 Bartsch, R. A.; Wieggers, K. E.; Guritz, D. M. *J. Am. Chem. Soc.* 96, 430-433 (1974).

6822 Balakrishnan, M.; Rao, G. V.; Venkatasubramanian, N. *J. Chem. Soc. Perkin Trans. II*, 6-10 (1974).

6825 Hanson, J. R. *Synthesis*, 1-8 (1974).

6830 Robinson, H. B.; Valley, D. J. *U.S. Pat.* 3,264,536 (C1. 317-258) (Aug. 2, 1966).

6831 Barth, B. P. *U.S. Pat.* 3,370,107 (C1. 260-901) (Feb. 20, 1968).

6847 Minoura, Y.; Shiina, K.; Yoshikawa, K. *J. Polymer Sci. A-1*, 5, 2843-2856 (1967).

6878 Byval'kevich, O. G.; Leshina, T. V.; Shein, S. M. *Izv. Sib. Otd. Akad. Nauk. SSSR, Ser. Khim. Nauk.* 1973, 114-116; *CA* 80, 36780.

6937 Abe, T. *Chem. Lett. (Japan)*, 1339-1342 (1973).

6947 Fincini, J.; D'Angelo, J.; Noire, J. *J. Am. Chem. Soc.* 96, 1213-1214 (1974).

6970 Akhtar, M.; Barton, D. H. R.; Sammes, P. G. *J. Am. Chem. Soc.* 87, 4601-4607 (1965).

6971 Kress, T. J. *U.S.* 3,794,642 (C1. 260-251R) (Feb. 26, 1974).

6972 Hauser, F. M.; Huffman, R. C. *Tetrahedron Lett.* 905-908 (1974).

6988 Su, C.-W.; Watson, J. W. *J. Am. Chem. Soc.* 96, 1854-1857 (1974).

7022 Krapcho, A. P.; Jahngen, E. G. E. Jr.; Lovey, A. J.; Short, F. W. *Tetrahedron Lett.* 1091-1094 (1974).

7028 Binger, P. *Synthesis*, 190-192 (1974).

7031 Henbest, H. B.; Trocha-Grimshaw, J. *J. Chem. Soc. Perkins Trans. I*, 601-603 (1974).

7044 Sharma, A. K.; Swern, D. *Tetrahedron Lett.* 1503-1506 (1974).

7047 Kende, A. S.; Wade, J. J.; Ridge, D.; Poland, A. *J. Org. Chem.* 39, 931-937 (1974).

7071 Zu Reckendorf, W. M.; Wassiliadou-Micheli, N. *Ber.* 107, 1188-1194 (1974).

7073 Baron, A. L. *U.S.* 3,532,677 (C1. 260-79.3) (Oct. 6, 1970); *CA* 73, 121223R.

7080 Ferland, J. M. *Can. J. Chem.* 52, 1652-1661 (1974).

7104 D'Alessandro, W. J. *U.S.* 3,455,866 (C1. 260-37, C 08G, F 16D) (July 15, 1969); *CA* 71, 62072Z (1969).

7108 Kornblum, N.; Boyd, S. D.; Ono, N. *J. Am. Chem. Soc.* 96, 2580-2587 (1974).

7115 Smith, P. A. S.; Bruckmann, E. M. *J. Org. Chem.* 39, 1047-1054 (1974).

7153 DeMeijere, A. *Ber.* 107, 1684-1701 (1974).

7156 Hoyt, J. M.; Williams, M. Jr. *U.S.* 3,780,004 (C1. 260-87.3) (Dec. 18, 1973).

7158 Jacobs, R. L. *U.S.* 3,813,446 (C1. 260-622 R) (May 28, 1974).

7173 Haugwitz, R. D.; Maurer, B. V.; Narayanan, V. L. *J. Org. Chem.* 39, 1359-1361 (1974).

7184 Oda, M.; Kayama, Y.; Kitshara, Y. *Tetrahedron Lett.* 2019-2022 (1974).

7196 Rose, J. B. *Polymer* 15, 1456-465 (1974).

7205 St. Clair, T. L.; Bell, H. M. *J. Polymer Sci. Polymer Chem. Ed.* 12, 1321-1322 (1974).

7229 Ferro, A.; Naves, Y.-R. *Helv. Chim. Acta.* 57, 1152-1155 (1974).

7234 James, B. G.; Pattenden, G. *J. Chem. Soc. Perkin Trans. I*, 1204-1208 (1974).

7255 Segawa, H.; Itoi, K. *Japan* 73, 19,557 (C1. C08G, B 01 J) (June 14, 1973); *CA* 80,

134072X.

7260 Santos, E.; Dymont, F. *Plating* (East Orange, N.J.) 60, 821-822 (1973); CA 79, 99733G.

7282 Youssef, A. A.; Sharaf, S. M. *J. Org. Chem.* 39, 1705-1707 (1974).

7285 Wilczynski, J. J.; Johnson, H. W. Jr. *J. Org. Chem.* 39, 1909-1915 (1974).

7293 Griffith, J. R.; O'Rear, J. G. *Synthesis*, 493 (1974).

7331 Ryan, M. D.; Evans, D. H. *J. Electrochem. Soc.* 121, 881-883 (1974).

7361 Krapcho, A. P. *Synthesis* 383-419 (1974).

7459 Nakagawa, S.; Takehara, Z.; Yoshizawa, S. *Denki Kagaku* 41, 880-883 (1973); CA 80 151, 952Q.

7460 Vitali, R.; Gladiali, S.; Gardi, R. *Gazz. Chim. Ital.* 102, 673-678 (1972); *Synthesis* 454 (1974).

7476 Mariano, P. S.; Watson, D. *J. Org. Chem.* 39, 2774-2778 (1974).

7507 Boeckman, R. K. Jr.; Ganem, B. *Tetrahedron Lett.* 913 (1974); *Synthesis*, 748 (1974).

7527 Wu, M.-C.; Anderson, L.; Slife, C. W.; Jensen, L. J. *J. Org. Chem.* 39, 3014-3020 (1974).

7528 Brand, W. W.; Bullock, M. W. U.S. 3,842,096 (C1. 260-327 M) (Oct. 15, 1974).

7533 Thummel, R. P. *J. Chem. Soc. Chem. Commun.* 899-900 (1974).

7536 Ghera, E.; Shoua, S. *Tetrahedron Lett.* 3843-3846 (1974).

7540 Balakrishnan, M.; Rao, G. V.; Venkatasubramanian, N. *J. Indian Chem. Soc.* 51, 537-539 (1974).

7547 Tokoroyama, T.; Matsuo, K.; Kanazawa, R.; Kotsuki, H.; Kubota, T. *Tetrahedron Lett.* 3093-3096 (1974).

7552 Mully, M.; Zsindely, J.; Schmid, H. *Chimia* 28, 62 (1974); *Synthesis*, 604 (1974).

7553 Gulbenk, A. H.; Horne, D. J.; Johnston, H. U.S. 3,746,707 (C1. 260-243AN; CO 7D) (July 17, 1973); CA 79, 105301H.

7573 Meresaar, U. *Acta. Chem. Scand.* A28, 656-660 (1974).

7582 Stetter, H.; Schreckenber, M. *Ber.* 107, 210-214 (1974); *Synthesis*, 63 (1975).

7608 Kocienski, P. J. *J. Org. Chem.* 39, 3285-3296 (1974).

7609 Rao, Y. S.; Filler R. *J. Org. Chem.* 39, 3304-3305 (1974); *Synthesis*, 543 (1975); CA 82, 16,473K.

7613 Varkey, T. E.; Whitfield, G. F.; Swern, D. *J. Org. Chem.* 39, 3365-3372 (1974).

7619 Rose, J. B. *Chimia* 28, 561-567 (1974).

7641 Fleming, R. H.; Quina, F. H.; Hammond, G. S. *J. Am. Chem. Soc.* 96, 7738-7741 (1974).

7643 Eliason, R.; Kreevoy, M. M. *J. Phys. Chem.* 78, 2658-2659 (1974).

7655 Challis, B. C.; Kerr, S. H.; McDermott, I. R. *J. Chem. Soc. Perkin Trans. II*, 1829-1832 (1974).

7657 Girdler, D. J.; Norris, R. K. *Tetrahedron Lett.* 431-434 (1975).

7691 Iguchi, Y.; Kori, S.; Hayashi, M. *J. Org. Chem.* 40, 521-523 (1975).

7692 Martin, R. L.; Norcross, B. E. *J. Org. Chem.* 40, 523-524 (1975).

7699 Thompson, R. M.; Duling, I. N. U.S. 3,738,960 (C1. 260-49) (June 12, 1973).

7709 Leslie, V. J.; Newton, A. B.; Rose, J. B. U.S. 3,775,368 (C1. 260-49) (Nov. 27, 1973).

7710 Heath, D. R.; Wirth, J. G. U.S. 3,869,499 (C1. 260-465 F) (March 4, 1975).

7729 Corey, E. J.; Shiner, C. S.; Volante, R. P.; Cyr, C. R. *Tetrahedron Lett.* 1161-1164 (1975).

7737 Belanger, A.; Brassard, P. *Can. J. Chem.* 53, 195-200 (1975).

7756 Doddi, G.; Mencarelli, P.; Stegel, F. *J. Chem. Soc. Chem. Commun.*, 273-274 (1975).

7763 Johnson, D. C.; Nicholson, M. D.; Haigh, F. C. *IPC Technical Paper Series No. 5* (April 1975).

7772 Reinhold, D. F.; Sletzinger, M.; Chemerda, J. M. U.S. Pat. 3,366,679 (C1. 260-519) (Jan. 30, 1968).

7844 Broxton, T. J.; Deady, L. W. *J. Org. Chem.* 40, 2906-2910 (1975).

7865 Schexnayder, M. A.; Engel, P. S. *J. Am. Chem. Soc.* 97, 4825-4836 (1975).

7867 Hanzlik, R. P.; Shearer, G. O. *J. Am. Chem. Soc.* 97, 5231-5233 (1975).

7943 Omura, K.; Sharma, A. K.; Swern, D. *J. Org. Chem.* 41, 957-962 (1976).

7950 Pfeffer, P. E.; Silbert, L. S. *J. Org. Chem.* 41, 1373-1379 (1976).

7984 Firestone, R. A.; Reinhold, D. F.; Sletzinger, M. U.S. 3,401,178 (C1. 260-340.5) (Sept. 10, 1968).

8008 Diem, H.; Dudeck, C.; Lehmann, G. U.S. 3,966,727 (C1. 260-249.9) (June 29, 1976).

8017 Chinn, L. J.; Desai, B. N.; Zawadzki, J. F. *J. Org. Chem.* 40, 1328-1331 (1975).

8030 San Filippo, J. Jr.; Chern, C.-I.; Valentine. *J. S. J. Org. Chem.* 40, 1678-1680 (1975).

8033 Harvey, R. G.; Goh, S. H.; Cortez, C. *J. Am. Chem. Soc.* 97, 3468-3479 (1975).

8043 Auerbach, A.; Indictor, N.; Kruger, A. *Macromolecules* 8, 262-266 (1975).

- 8050 Bartsch, R. A. *Accounts Chem. Res.* 8, 239-245 (1975).
- 8054 Lowe, O. G. *J. Org. Chem.* 40, 2096-2098 (1975).
- 8063 Broxton, T. J.; Muir, D. M.; Parker, A. J. *J. Org. Chem.* 40, 3230-3233 (1975).
- 8065 Chapas, R. B.; Knudsen, R. D.; Nystrom, R. F.; Snyder, H. R. *Org. Chem.* 40, 3746-3748 (1975).
- 8070 Barton, A. F. M. *Chem. Revs.* 75, 731-753 (1975).
- 8095 Lowe, O. G. *J. Org. Chem.* 41, 2061-2064 (1976).
- 8105 Gibian, M. J.; Ungermann, T. *J. Org. Chem.* 41, 2500-2502 (1976).
- 8108 Grayston, M. W.; Lemal, D. M. *J. Am. Chem. Soc.* 98, 1278-1280 (1976).
- 8118 Vollheim, G.; Troger, K.-J.; Lippert, G. U.S. 3,897,499 (C1. 260-580) (July 29, 1975).
- 8184 Kimura, K.; Inaki, Y.; Takemoto, K. *Angew. Makromol. Chem.* 49, 103-114 (1976).
- 8185 Kimura, K.; Hanabusa, K.; Inaki, Y.; Takemoto, K. *Angew. Makromol. Chem.* 52, 129-142 (1976).
- 8227 Rooney, M. L. *Polymer* 17, 555-558 (1976).
- 8238 Sowa, J. R.; Lamby, E. J.; Calamai, E. G.; Benko, D. A.; Gordinier, A. *Organic Prep. Proced. Int.* 7, 137-144 (1975).
- 8254 Schmidt, U.; Gombos, J.; Haslinger, E.; Zak, H. *Ber.* 109, 2628-2644 (1976).
- 8255 Marschall, H.; Muehlkamp, W. B. *Ber.* 109, 2785-2792 (1976).
- 8261 Masamune, T.; Numata, S.; Matsue, H.; Matsuyuke, A.; Sato, T.; Murase, H. *Bull. Chem. Soc. Jap.* 48, 2294-2302 (1975).
- 8276 Akerblom, E. B. U.S. Pat. 3,886,208 (C1. 260-518 R) (May 27, 1975).
- 8287 White, D. W. U.S. Pat. 3,852,242 (C1. 2060-4 CZ) (Dec. 3, 1974).
- 8306 Murai, A.; Ono, M.; Masamune, T. *J. Chem. Soc. Chem. Commun.* 864-865 (1976).
- 8311 Gray, A. P.; Cepa, S. P.; Solomon, I. J.' Aniline, O. *J. Org. Chem.* 41, 2435-2439 (1976).
- 8339 Brimacombe, J. S.; Da'Aboul, I.; Yuker, L. C. N. *J. Chem. Soc. Perkin Trans. I*, 979-984 (1975).
- 8340 Jones, E. R. H.; Meakins, G. D.; Miners, J. O.; Wilkins, A. L. *J. Chem. Soc. Perkin Trans. I*, 2308-2312 (1975).
- 8344 Cavazza, M.; Biggi, G.; DelCima, F.; Pietra, F. *J. Chem. Soc. Perkin Trans. II*, 1636-1638 (1975).
- 8350 Markezich, R. L. U.S. 3,992,406 (C1. 260-326 N) (Nov. 16, 1976).
- 8360 James, G. G.; Pattenden, G. *J. Chem. Soc. Perkin Trans. I*, 1476-1479 (1976).
- 8372 Alumni, S.; Baciocchi, E. *J. Chem. Soc. Perkins Trans.* 11, 488-491 (1976).
- 8399 Knipe, A. C.; Sridhar, N. *Synthesis*, 606-607 (1976).
- 8400 Aida, T.; Akasaka, T.; Furukawa, N.; Oae, S. *Bull. Chem. Soc. Jap.* 49, 1117-1121 (1976).
- 8405 Aida, T.; Akasaka, T.; Furukawa, N.; Oae, S. *Bull. Chem. Soc. Jap.* 49, 1441-1442 (1976).
- 8408 Sekiguchi, S.; Tsutsumi, K.; Shizuka, H.; Matsui, K.; Itagaki, T. *Bull. Chem. Soc. Jap.* 49, 1521-1523 (1976).
- 8410 Timoto, S.; Taniyasu, T.; Miyake, T.; Okano, M. *Bull. Chem. Soc.* 49, 1931-1936 (1976).
- 8418 Uzuki, T.; Takahashi, M.; Komachinya, Y.; Wakamatsu, H. U.S. 3,991,077 (C1. 260-326.14 T) (Nov. 9, 1976).
- 8436 Kornblum, N.; Cheng, L.; Kerber, R. C.; Kester, M.; Newton, B. M.; Pinnick, H. W.; Smith, R. G.; Wade, P. A. *J. Org. Chem.* 41, 1560-1564 (1976).
- 8451 Padwa, A.; Au, A. *J. Am. Chem. Soc.* 98, 5581-5590 (1976).
- 8455 Huang, S. L.; Omura, K.; Swern, D. *J. Org. Chem.* 41, 3329-3331 (1976); *Synthesis*, 505 (1977); CA 85-142716S.
- 8501 Toray Inds. KK Japan. J7 6028-734 (C1. A14F01) (A32 A94) (Aug. 20, 1976).
- 8506 Seymour, R. B.; Johnson, E. L. *J. Appl. Polym. Sci.* 20,3425-3429 (1976).
- 8529 Mozdzen, E. C. *Purdue University Organic Seminar* (Jan. 29, 1977).
- 8548 Grossert, J. S.; Langler, R. F. *Can. J. Chem.* 55, 407-420 (1977).
- 8551 Haines, A. H. *Chem. Ind. (London)*, 883-887 (1976).
- 8554 Bailes, P. J. *Chem. Ind. (London)*, 69-73 (1977).
- 8564 Adams, J. H.; Gupta, P.; Khan, M. S.; Lewis, J. R.; Watt, R. A. *J. Chem. Soc. Perkin Trans I*, 2089-2093 (1976).
- 8576 Kennewell, P. D.; Taylor, J. B. *Chem. Soc. Revs.* 4, 189-210 (1975).
- 8582 Bartsch, R. A.; Roberts, D. K. *Tetrahedron Lett.* 321-322 (1977).
- 8601 Iwakura, Y.; Uno, K.; Nguyen, C. *Makromol. Chem.* 175, 2079-90 (1974); CA 81, 152729E (1974).
- 8603 Kamino, J.; Okamoto, S. *Japan.* 73, 29,811 (C1. D 01F) (Sept. 13, 1973); CA81, 38758P (1974).

- 8658 Nakano, F.; Sugishita, M. Japan. 74 24,057 (C1. C 07C, B 01J) (June 20, 1974); CA 82, 111772R.
- 8677 Richardson, T.; Hustad, G. O. U.S. 3,658731 (C1. 260-2.5 BD) (April 25, 1972).
- 8683 Heath, D. R.; Wirth, J. G. U.S. 3,873,593 (C1. 260-465 F) (March 25, 1975).
- 8685 Heath, D. R.; Takekoshi, T. U.S. 3,879,428 (C1. 260-346.3) (April 22, 1975).
- 8690 Wasson, B. K.; Williams, H. W. R. U.S. 3,812,150 (C1. 260-326.15; C07D) (May 21, 1974); CA 81, 37585T (1974).
- 8696 Gani, V.; Viout, P. Tetrahedron 32, 2883-2889 (1976).
- 8714 Takekoshi, T. U.S. 4,024,110 (C1. 260-47 CZ) (May 17, 1977).
- 8717 Mueller, W. H. U.S. 4,028,417 (C1. 260-586 C) (June 7, 1977).
- 8735 Szmant, H. H.; Birke, A.; Lau, M. P. J. Am. Chem. Soc. 99, 1863-1871 (1977).
- 8759 Carson, J. R.; Hortenstine, J. T.; Maryanoff, B. E.; Molinari, A. J. J. Org. Chem. 42, 1096-1098 (1977).
- 8766 Mandell, L.; Daley, R. F.; Day, R. A. Jr. J. Org. Chem. 42, 1461-1462 (1977).
- 8779 Roedig, A.; Zaby, G.; Scharf, W. Ber. 110, 1484-1491 (1977).
- 8809 Galli, C.; Mandolini, L. J. Chem. Soc. Perkin Trans. II, 443-445 (1977).
- 8825 Attwood, T. E.; Barr, D. A.; Feasey, G. G.; Leslie, V. J.; Newton, A. B.; Rose, J. B. Polymer 18, 354-358 (1977).
- 8830 Ito, Y.; Fujii, S.; Konoike, T.; Saegusa, T. Synthetic Commun. 6, 429-433 (1976); Synthesis 283 (1977).
- 8832 Andreev, S. M.; Tsiryapkin, V. A.; Samoilova, N. A.; Mironova, N. V.; Davidovich, Y. A.; Rogozhin, S. V. Synthesis 303-304 (1977).
- 8833 Mukaiyama, T.; Sato, T.; Suzuki, S.; Inoue, T.; Nakamura, H. Chem. Lett. (1) 95-98 (1976); Synthesis 433 (1977).
- 8838 Pri-Bar, I.; Buchman, O.; Blum, J. Tetrahedron Lett. 1443-1446 (1977).
- 8843 Guenther, H. J.; Jaeger, V.; Skell, P. S. Tetrahedron Lett. 2539-2542 (1977).
- 8861 Markgraf, J. H.; Ibsen, M. S.; Kinny, J. B.; Kuper, J. W.; Lurie, J. B.; Marrs, D. R.; McCarthy, C. A.; Pile, J. M.; Pritchard, T. J. J. Org. Chem. 42, 2631-2632 (1977).
- 8867 Hofheinz, W. U.S. 4,042,597 (C1. 548-339) (Aug. 16, 1977).
- 8885 Kabalka, G. W.; Baker, J. D. Jr.; Neal, G. W. J. Org. Chem. 42, 512-517 (1977).
- 8888 Hajos, Z. G. U.S. 4,048,195 (C1. 260-345.9 S) (Sept. 13, 1977).
- 8906 Ritz, J.; Reese, J. Ger. Offen. 2,250,232 (C1. C 07C, C09D) (Apr. 25, 1974); CA 82, 113469W (1975).
- 8923 Razumovskii, S. D.; Shatokhina, E. L.; Malievskii, A. D.; Zaikov, G. E. Izv. Akad. Nauk. SSSR, Ser. Khim. 543-546 (1975); CA 82, 169742X (1975).
- 8927 Carosello, T. F.; Weinberg, J. Ger. Offen. 2,432,685 (C1. C 08F, C 04B, A 01N) (Feb. 6, 1975); CA 82, 171903U.
- 8951 Gigg, R.; Conant, R. J. Chem. Soc. Perkin Trans. I, 2006-2014 (1977).
- 8953 Adams, C.; Gold, V.; Reuben, D. M. E. J. Chem. Soc. Perkin Trans. II, 1466-1472 (1977).
- 8954 Adams, C.; Gold, V.; Reuben, D. M. E. J. Chem. Soc. Perkin Trans. II, 1472-1478 (1977).
- 8955 Liu, M. T. H.; Jennings, B. M.; Yamamoto, Y.; Maruyama, K. J. Chem. Soc. Perkin Trans. II, 1490-1492 (1977).
- 8960 Agarwal, S. K.; Moorthy, S. N.; Mahrotra, I.; Devaprabhakara, D. Synthesis 483 (1977).
- 8970 Philipp, B.; Schleicher, H.; Wagenknecht, W. Chemtech 702-709 (Nov. 1977).
- 8984 Relles, H. M.; Johnson, D. S.; Manello, J. S. J. Am. Chem. Soc. 99, 6677-6686 (1977).
- 9096 Williams, F. J.; Donahue, P. E. J. Org. Chem. 42, 3414-3419 (1977).
- 9107 Mendelson, W. L.; Webb, R. L. U.S. 4,057,585 (C1. 260-612 D) (Nov. 8, 1977).
- 9135 Troostwijk, C. B.; Kellogg, R. M. J. Chem. Soc. Chem. Commun. 932-933 (1977).
- 9138 Aydeiran, D.; Bamkole, T. O.; Hirst, J.; Onyido, I. J. Chem. Soc. Perkin Trans. II 1580-1583 (1977).
- 9142 McLennan, D. J. J. Chem. Soc. Perkin Trans. II, 1708-1715 (1977).
- 9142 Grout, A.; McLennan, D. J.; Spackman, I. H. J. Chem. Soc. Perkin Trans. II, 1758-1763 (1977).
- 9145 Wasson, B. K.; Williams, H. W. R. U.S. 3,944,560 (C1. 260-302H) (March 16, 1976); CA 85, 94415U.
- 9150 Cresswell, R. M.; Mentha, J. W. U.S. 3,878,252 (C1. 260-607A; C07C) (April 15, 1975); CA 83, 78855R.
- 9170 Turbak, A. F.; Hammer, R. B.; Portnoy, N. A.; West, A. C. U.S. 4,076,933 (C1. 536-30) (Feb. 28, 1978).
- 9175 Kuznetsov, V. V.; Grigor'ev, V. P.; Shpan'ko, S. P.; Bozhenko, L. G. Zashch. Met. 1, 631-

- 634 (1975); CA 84, 10359X.
- 9196 Amick, D. R. *J. Heterocycl. Chem.* 12, 1051-1052 (1975); CA 84, 59082R.
- 9222 DeOliveira, L. A.; Toma, H. E.; Giesbrecht, E. *Inorg. Nucl. Chem. Lett.* 12, 195-203 (1976); C. A. 84, 112283K.
- 9244 Von Strandtmann, M.; Shavel, J. Jr.; Klutchko, S. U.S. 3,892,739 (C1. 260-243R; C07D) (July 1, 1975); CA 84, 43632J.
- 9249 Von Strandtmann, M.; Shavel, J. Jr.; Klutchko, S.; Cohen, M. U.S. 3,937,704 (C1. 260-250C; C07D) (Feb. 10, 1976); CA 84, 150650K.
- 9338 Kremley, M. M.; Fialkov, Y. A. *Ukr. Khim. Zh. (Russ. Ed.)* 42, 1058-1060 (1976); CA 86, 72048V.
- 9396 Kuznetsov, V. V.; Bozhenko, L. G.; Petrova, I. V. *Izv. Sev.-Kavk. Nauchn. Tsentra Vyssh. Shk., Ser. Estestv. Nauk.* 4, 47-79 (1976); CA 86, 179414P.
- 9402 Von Strandtmann, M.; Shavel, J. Jr.; Klutchko, S.; Cohen, M. P. U.S. 3,843,730 (C1. 260-592; C 07C) (Oct. 22, 1974), CA 82, 125172G.
- 9408 Handa, S.; Tanaka, Y.; Nishibata, A.; Ueda, S.; Inamoto, Y.; Saito, M.; Tanimoto, F.; Kitano, H. U.S. 4,059,610 (C1. 544-193) (Nov. 22, 1977).
- 9412 Mimoun, H.; Thao, D.; Seree DeRochi, I. U.S. 4,085,145 (C1. 260-592) (April 18, 1978).
- 9423 Zollinger, H. *Angew. Chem. Intern. Ed. Engl.* 17, 141-150 (1978).
- 9434 Takita, Y.; Maehara, T.; Yamazoe, N.; Seiyama, T. *Bull. Chem. Soc. Jap.* 51, 669-670 (1978).
- 9439 Jawdosiuik, M.; Kmiotek-Akarzynska, I.; Wilczynski, W. *Can. J. Chem.* 56, 218-220 (1978).
- 9464 Tokura, N. *Garasu Kogyo Gijutsu Shoreikai Kenkyu Hokoku* 28, 85-94 (1976); CA 87, 39046R.
- 9488 Buncel, E.; Wilson, H. *Advances in Physical Organic Chemistry*, Academic Press, London, New York, San Francisco, Vol. 14, 133-202 (1977).
- 9541 Wagenknecht, W.; Scheicher, H.; Philipp, B. *Faserforsch. Textiltech.* 28, 546-547 (1977); CA 88, 75457B.
- 9563 Maruthamuthu, P.; Santappa, M. *Indian J. Cham., Sect. A* 16A, 43-45 (1978); CA 88, 126959E.
- 9567 Trofimov, B. A.; Mikhaleva, A. I.; Korostova, S. E.; Vakul'skaya, T. I.; Poguda, I. S.; Voronkov, M. G. *Zh. Prikl. Khim. (Leningrad)* 51, 117-120 (1978); CA 137048H.
- 9581 Tsenyuga, V. A.; Nadezhina, N. A.; Ovchinnikov, p. N.; Timofeeva, E. Y. *Zh. Org. Khim.* 14, 337-339 (1978); C. A. 88, 169698M.
- 9604 Hagedorn III, A. A.; Farnum, D. G. *J. Org. Chem.* 42, 3765-3767 (1977).
- 9605 Marvel, E. N.; Reed, J. K.; Gaenzler, W.; Tong, H. *J. Org. Chem.* 42, 3783-3784 (1977).
- 9638 Ouchi, T.; Tatsumi, A.; Imoto, M. *J. Polymer Sci. Polymer Chem. Ed.* 16, 707-711 (1978).
- 9652 Kazanskii, K. S.; Solov'yanov, A. A.; Bubrovsky, S. A. *Makromol. Chem.* 179, 969-973 (1978); CA 88, 170564W.
- 9678 Radhakrishnamurti, P. S.; Padhi, S. C. *Curr. Sci.* 46, 517-518 (1977); CA 87, 183721Z.
- 9686 Wirht, J. G.; Heath, D. R. U.S. 3,787,364 (C1. 260-61) (Jan. 22, 1974).
- 9707 Reetz, M. T.; Eibach, F. *Angew. Chem. Intern. Ed. Engl.* 17, 278-279 (1978).
- 9727 Salomon, R.G.; Sinha, A.; Salomon, M.F. *J. Am. Chem. Soc.* 100, 520-526 (1978).
- 9746 Irie, H.; Katakawa, J.; Mizuno, Y.; Udaka, S.; Taga, T.; Osaki, K. *J. Chem. Soc. Chem. Comm.* 717-718 (1978).
- 9752 James, B.R.; Morris R.H. *J. Chem. Soc. Chem. Commun.* 929-930 (1978).
- 9761 Julia, M.; Righini, A.; Uguen, D. *J. Chem. Soc. Perkin Trans I*, 1646-1651 (1978).
- 9767 Dirlam, J.P.; Cue, B.W. Jr.; Gombatz, K.J. *J. Org. Chem.* 43,76-79 (1978).
- 9769 Krapcho, A.P.; Weimaster, J. F.; Eldridge, J.M.; Jahngen, E.G.E. Jr.; Lovey, A.J.; Stephens, W.P. *J. Org. Chem.* 43, 138-47 (1978); CA 88, 50032Z.
- 9771 Williams, F.J.; Donahue, P.E. *J. Org. Chem.* 43,250-254 (1978).
- 9773 Cocivera, M.; V.; Woo, K.W.; Effio, A. *J. Org. Chem.* 43, 1140-1145 (1978); CA 88,120237W.
- 9780 Welch, S.C.; Rao, A.S.C.P. *J. Org. Chem.* 43, 1957-1961 (1978).
- 9783 Hutchins, R.O.; Kandasamy, D.; Dux III, F.; Maryanoff, C.A.; Rotstein, D.; Goldsmith, B.; Burgoyne, W.; Cistone, F.; Dalessandro, J.; Puglis, J. *J. Org. Chem.* 43,1140-1145 (1978).
- 9786 Mancuso, A.J.; Huang, S.-L.; Swern, D. *J. Org. Chem.* 43,2480-2482 (1978); CA 89,2369OT.
- 9825 Wendler, N.L.; Girota, N.N.; Zelawski, Z.S. U.S. Pat. 4,094,878 (Cl. 260-297Z) (June 13, 1978); CA89,163425U.
- 9850 Johnson, D.C.; Nicholson, M.D. U.S. Pat4,097,666 (Cl. 536-57) (June 27, 1978)
- 9871 Shieh, B.; Moriguchi, A.; Matsubara, Y. *Nippon Kagaku Kaishi* 1167-9 (1978); CA 90,6549R.
- 9874 Iwamuro, H.; Ohshio, T.; Matsubara, Y. *Nippon Kagaku Kaishi*, 909-11 (1978); CA 90,23267Q.

- 9895 Hammer, R.B.; O'Shaughnessy, M.E.; Strauch, E.R. Turbak, A.F. *J. Appl. Polym. Sci.* 23,485-94 (1979); CA90, 122862M.
- 9926 Omura, K.; Swern, D. *Tetrahedron* 34, 1651-1660 (1978).
- 9928 Blancou, H.; Moreau, P.; Commeyras, A. *Tetrahedron* 33,2061-2067 (1977).
- 9944 Savignac, P.; Breque, A.; Bartet, B.; Wolf, R. *C.R.H. Acad. Sci. Ser. C*, 13-16 (1978).
- 9949 Kim, J. K.; Lingman, E.; Caserio, M.C. *J. Org. Chem.* 43,4545-4546 (1978).
- 9960 Babler, J.H. *W.S.* 4,175,204 (Cl. 560-262) (Nov. 20, 1979).
- 9961 Johnson, R.N.; Farnham, A.G. *U.S.* 4,175,175 (Cl. 528-125) (Nov. 20, 1979).
- 9964 Dryden, H.L.Jr.; Sarcos, M.G. Westrich, J.P. *U.S.* 4,141,920 (Cl. 260-607B; C07C148/00) (Feb. 27, 1979); CA 90 168063E.
- 9985 Larcheveque, M.; Mulot, P. *Can. J. Chem.* 57, 17-20 (1979).
- 9986 Gregory, B.; Bullock, E.; Chen, T.S. *Can. J. Chem.* 57,44-52 (1979).
- 10000 Fatma, W.; Iqbal, J.; Ismail, H.; Ishratullah, K.; Shaida, W.A.; Rahman, W. *Chem. Ind. (London)*, 315-316 (1979).
- 10002 Chollet, A.; Hagenbuch, J.P.; Vogel, P. *Helv. Chim. Acta.* 62,511-524 (1979).
- 10008 Kornblum, N.; Carlson, S.C.; Smith, R.G. *J. Am. Chem. Soc.* 101,647-657 (1979).
- 10011 Bartsch, R.A.; Read, R.A.; Larsen, D.T.; Roberts, D.K.; Scott, K.J.; Cho, B.R. *J. Am. Chem. Soc.* 101, 1176-1181 (1979).
- 10032 Dossena, A.; Marchelli, R.; Casnati, G. *J. Chem. Soc., Chem. Commun.* 370-371 (1979); CA 91,211782Y.
- 10043 Gigg, R. *J. Chem. Soc.; Perkin Trans I.* 712-718 (1979).
- 10044 Tanaka, H.; Nagai, Y.; Irie, H.; Uyeo, S.; Kuno, A. *J. Chem. Soc.; Perkin Trans. I*, 874-878 (1979).
- 10048 Guest, D.W.; Williams, D.H. *J. Chem. Soc.; Perkin Transl*, 1695-1697 (1979).
- 10066 Babler, J. H.; Coghlan, M.J.; Feng, M.; Fries, P. *J. Chem.* 44,3157-3162 (1979).
- 10077 Jarvis, B.B.; Nicholas, P.E. *J. Chem.* 44, 2951-2952 (1979).
- 10078 Uijtewaal, A.P.; Jonkers, F.L.; Van der Gen, A. *J. Chem.* 44,3157-3162 (1979).
- 10084 Mancuso, A.J.; Brownfain, D.S.; Swern, D. *J. Chem.* 44, 4148-4150 (1979); C.A. 91,210384H.
- 10085 Detty, M.R. *J. Chem.* 44,4528-4531 (1979).
- 10086 Kornblum, N.; Singaram, S. *J. Chem.* 44,4727-4729 (1979).
- 10091 Kamogawa, H.; Koizumi, H.; Nanasawa, M. *J. Polymer Sci.; Polymer Chem. Ed.* 11,9-18 (1979).
- 10116 Kurita K.; Hirakawa, N.; Iwakura, Y. *Makromol. Chem.* 180,855-858 (1979).
- 10123 Kurita K.; Hirakawa, N.; Morinaga, H.; Iwakura, Y. *Makromol. Chem.* 180, 2769-2773 (1979).
- 10127 Olah, G.A.; Narang, S.C.; Gupta, B.G.; Malhotra, R.; *Synthesis* 61-2 (1979) CA 90, 103544T.
- 10134 Chari, R.V.J.; Reed, J.N.; Turnbull, K. *Tetrahedron Lett.* 1481-1484
- 10139 Still, I.W.J.; Reed, J.N.; Turnbull, K. *Tetrahedron Lett.* 1481-1484 (1979).
- 10143 Wade, T.N.; Gaymard, F.; Guedg, R. *Tetrahedron Lett.* 2681-2682 (1979).
- 10224 Morimoto, A.; Nanbu, N.; Nanby, T. *Jpn Kokai Tokkyo Koho* 79,44.611 (Cl. C07C147/02) (April 9, 1979); CA 91,91170Y.
- 10286 Takagi, U.; Tsumura, R.; Mazaki, T. *Kokai Tokkyo Koho* 79,125,604 (Cl. C07 C79/04) (Sept. 29, 1979); CA92, 110519H.
- 10315 Gibbio, V.; Omato, F. *U.S.* 4,206,118 (Cl. 548-155) (Jun. 3, 1980).
- 10320 Bayer, H.O.; Swithenbank, C.; Yih, H.R.Y. *U.S.* 4,220, 468 (Cl. 71-124) (Sept. 2, 1980).
- 10368 Turbak, A.F.; Hammer, R.B.; Davies, R.E.; Hergert, H.L. *Chemtech*, 51-57 (1980).
- 10394 Tanaka, R.; Zheng, S.Q.; Kawaguchi, K.; Tanaka, T. *J. Org. Chem. Soc.; Perkin Trans. II*, 1714-1720 (1980).
- 10399 Kornblum, N.; Fifolt, M.J. *J. Org. Chem.* 45,2404-2408 (1980).
- 10409 Broxton, T.J.; Deady, L.W.; Rowe, J.E. *J. Org. Chem.* 45,2404-2408 (1980).
- 10411 Olmstead, W.N.; Margolin, Z.; Bordwell, F.G. *J. Org. Chem.* 45,3295-3299 (1980).
- 10422 Pri-Bar, I.; Buchman, O. *J. Org. Chem.* 45,4418-4428 (1980).
- 10434 Takeshoni, T.; Wirth, J.G.; Heath, D.R.; Kochanowski, J.E.; Manello, J.S.; Webber, M.J. *J. Polymer Sci.; Polymer Chem. Ed.* 18,3069-3080 (1980).
- 10437 Rokicki, G.; Kuran, W. *Makromol Chem.* 181,985-993 (1980).
- 10439 Kurita, K.; Hirakawa, N.; Iwakura, Y. *Makromol. Chem. Rapid Commun.* 1,695-662 (1980).
- 10443 Imai, Y.; Asamidori, Y.; Ueda, M. *Makromol. Chem. Rapid Commun.* 1, 659-662 (1980)
- 10454 Raduechel, B. *Synthesis* 292-295 (1980).
- 10458 Cariou, M. *Synthesis* 1045 (1980).
- 10465 Buchanan, D.H.; McComas, G. *Tetrahedron Lett.* 21,4317-4320 (1980).
- 10470 *Manual of Hazardous Chemical Reactions 1971*, National Fire Protection Association,

- International, Boston, MA 491M-100-101, (1971).
- 10569 Erickson, A.S. A Compilation of pKa's of 132 Organic Compounds, Crown Zellerbach, results unpublished (1979).
- 10720 Mancuso, A.J.; Swern, D. Synthesis, 165-185 (1981).
- 10762 Boldebuck, E.M.; Banucci, E.G. U.S.4,255,471 (Cl. 427-385.5) (Mar. 10, 1981).
- 10771 Carter, C.O. U.S. 4,267,034 (Cl. 208-323) (May 12, 1981).
- 16359 Tidwell, T.T. Synthesis, 857-70 (1990).